

Contents

RULES FOR MARINE POLLUTION PREVENTION SYSTEMS	4
Part 1 GENERAL.....	4
Chapter 1 GENERAL.....	4
1.1 General.....	4
Chapter 2 TERMINOLOGY AND ABBREVIATIONS	6
2.1 General.....	6
Part 2 SURVEYS	8
Chapter 1 GENERAL.....	8
1.1 General.....	8
1.2 Preparation for Surveys and Others	10
1.3 Verification Survey of Certificates, etc.....	11
1.4 Other	12
Chapter 2 REGISTRATION SURVEYS.....	13
2.1 Registration Surveys during Construction.....	13
2.2 Registration Surveys Not Built under the Survey.....	21
Chapter 3 REGISTRATION MAINTENANCE SURVEYS	22
3.1 Annual Surveys.....	22
3.2 Intermediate Surveys.....	25
3.3 Special Surveys.....	27
Chapter 4 OCCASIONAL SURVEYS	29
4.1 General.....	29
Part 3 CONSTRUCTION AND EQUIPMENT FOR THE PREVENTION OF POLLUTION BY OIL	30
Chapter 1 GENERAL.....	30
1.1 Application and Terminology.....	30
1.2 General Rules	31
Chapter 2 EQUIPMENT FOR THE PREVENTION OF POLLUTION BY OIL FROM MACHINERY SPACES	39
2.1 General.....	39
2.2 Storage and Discharge of Oil Residues (Sludge) (<i>Regulations</i> 12 and 13 of <i>Annex I</i>)	39
2.3 Oily-water Separating Equipment, Oil Filtering System, Oil Discharge Monitoring and Control System for Oily Bilge Water, and Oily Bilge Water Holding Tanks (<i>Regulation</i> 14 of <i>Annex</i> <i>I</i>)	40
2.4 Requirements for Installation (<i>Regulation</i> 14 of <i>Annex I</i>).....	42
Chapter 3 CONSTRUCTION AND EQUIPMENT FOR THE PREVENTION OF POLLUTION BY OIL CARRIED IN BULK.....	43
3.1 General.....	43
3.2 Hull Construction.....	43
3.3 Installations and Piping Arrangements	57
3.4 Crude Oil Washing System	59
Chapter 4 TRANSITIONAL REQUIREMENTS	63

4.1	General	63
4.2	General Requirements	66
4.3	Equipment for the Prevention of Pollution by Oil Carried in Bulk by Oil Tankers	66
Part 4	CONSTRUCTION AND EQUIPMENT FOR THE PREVENTION OF POLLUTION BY DISCHARGES OF NOXIOUS LIQUID SUBSTANCES IN BULK	69
Chapter 1	GENERAL	69
1.1	General	69
1.2	Definitions	69
Chapter 2	CONSTRUCTION AND EQUIPMENT	71
2.1	General	71
2.2	Requirements for Installation of Construction and Equipment	71
Chapter 3	(Deleted).....	73
Chapter 4	EQUIPMENT FOR THE PREVENTION OF DISCHARGE OF NOXIOUS LIQUID SUBSTANCES	74
4.1	General	74
4.2	Prewashing Systems (<i>Regulation 6 of Annex II</i>)	74
4.3	Stripping System (<i>Regulation 5 of Annex II</i>)	74
4.4	Discharge Arrangements below the Waterline	75
4.5	Arrangements for Discharge to Reception Facilities	76
4.6	Ventilated Washing System (<i>P&A Standards Appendix C</i>)	76
4.7	Segregated Ballast Tanks	76
Part 5	SHIPBOARD OIL POLLUTION EMERGENCY PLANS	78
Chapter 1	GENERAL	78
1.1	General	78
Chapter 2	TECHNICAL REQUIREMENTS	79
2.1	General	79
2.2	Entries in Shipboard Oil Pollution Emergency Plans	79
2.3	Appendices to Shipboard Oil Pollution Emergency Plans*	80
2.4	Additional Requirements for Oil Tankers of 5,000 <i>tonnes</i> Deadweight and above	80
Part 6	SHIPBOARD MARINE POLLUTION EMERGENCY PLAN FOR NOXIOUS LIQUID SUBSTANCES	81
Chapter 1	GENERAL	81
1.1	General	81
Chapter 2	TECHNICAL REQUIREMENTS	82
2.1	General	82
2.2	Entries in Shipboard Marine Pollution Emergency Plan for Noxious Liquid Substances.....	82
2.3	Appendices to Shipboard Marine Pollution Emergency Plan for Noxious Liquid Substances* 83	
Part 7	EQUIPMENT FOR THE PREVENTION OF POLLUTION BY SEWAGE	84
Chapter 1	GENERAL	84
1.1	General	84
Chapter 2	EQUIPMENT FOR THE PREVENTION OF POLLUTION BY SEWAGE FROM SHIPS 86	
2.1	General	86

2.2	Requirements for Installation of Equipment	86
Part 8	EQUIPMENT FOR THE PREVENTION OF AIR POLLUTION FROM SHIPS	88
Chapter 1	GENERAL	88
1.1	General	88
1.2	General Requirement	91
Chapter 2	EQUIPMENT FOR THE PREVENTION OF AIR POLLUTION FROM SHIPS	94
2.1	Nitrogen Oxides (NO _x) (<i>Regulation 13 of Annex VI</i>)	94
2.2	Sulphur Oxides (SO _x) and Particulate Matter (<i>Regulation 14 of Annex VI</i>)	98
2.3	Vapour Collection System (<i>Regulation 15 of Annex VI</i>)*	98
2.4	Incinerator (<i>Regulation 16 of Annex VI</i>)*	99
Chapter 3	ENERGY EFFICIENCY FOR SHIPS	101
3.1	General	101
3.2	Attained Energy Efficiency Design Index (Attained EEDI) (<i>Regulation 22 of Annex VI</i>)* ..	103
3.3	Attained Energy Efficiency Existing Ship Index (Attained EEXI) (<i>Regulation 23 of Annex VI</i>)	103
3.4	Required Energy Efficiency Design Index (Required EEDI) (<i>Regulation 24 of Annex VI</i>)*	103
3.5	Required Energy Efficiency Existing Ship Index (Required EEXI) (<i>Regulation 25 of Annex VI</i>)*	106
3.6	Ship Energy Efficiency Management Plan (SEEMP) (<i>Regulation 26 of Annex VI</i>)*	107
3.7	Statements of Compliance related to Fuel Oil Consumption Reporting and Operational Carbon Intensity Rating to be kept.....	108
3.8	Data Collection, Reporting and Retained related to Fuel Oil Consumption Reporting, etc. (<i>Regulations 27 of Annex VI</i>)*	108
3.9	Operational Carbon Intensity (<i>Regulations 28 of Annex VI</i>)	109
Part 9	CONSTRUCTION AND EQUIPMENT FOR THE PREVENTION FROM SHIPS OPERATING IN POLAR WATERS	110
Chapter 1	GENERAL	110
1.1	General	110
1.2	Definitions	110
Chapter 2	PREVENTION OF POLLUTION BY OIL	111
2.1	Shipboard Oil Pollution Emergency Plan and Others	111
2.2	Structural Requirements.....	111
Chapter 3	PREVENTION OF POLLUTION BY NOXIOUS LIQUID SUBSTANCES	112
3.1	Shipboard Marine Pollution Emergency Plan and Others	112
3.2	Construction and Equipment	112
Appendix I	GUIDANCE FOR THE DISCHARGE OF NOXIOUS LIQUID SUBSTANCES, ETC.	113
1.1	General	113
1.2	Discharge of Noxious Liquid Substances	113
1.3	Discharge of Noxious Liquid Substances, etc. in Polar Waters	114
1.4	Liquid Substances, etc. other than Noxious Liquid Substances	114

RULES FOR MARINE POLLUTION PREVENTION SYSTEMS

Part 1 GENERAL

Chapter 1 GENERAL

1.1 General

1.1.1 Application*

1 The Rules for Marine Pollution Prevention Systems (hereinafter referred to as “the Rules”) apply to the survey, construction and equipment for the prevention of pollution from ships classed with NIPPON KAIJI KYOKAI (hereinafter referred to as “the Society”) and intended to be registered as the Marine Pollution Prevention Installations under **Chapter 3 of the Regulations for the Classification and Registry of Ships**.

The “Marine Pollution Prevention Installations” means the construction and equipment specified in **Parts 3, 4, 7 and 8** and include the emergency plans specified in **Parts 5 and 6**.

2 Where there are special reasons for non-compliance with any requirements of the Rules, it may comply with other requirements modified by the Society on the basis of the Rules.

3 The other equipment of ships for the prevention of pollution, which is not required to be installed by the Rules, are to comply with as deemed appropriate by the Society.

4 The relevant requirements in the **Rules for the Survey and Construction of Steel Ships** apply to the materials, equipment, installation and workmanship of the systems, unless otherwise specified in the Rules.

1.1.2 Equivalents (*Regulation 5.1 of Annex I, Regulation 5.1 and 5.3 of Annex II*)*

1 The Society may allow any fittings, materials, appliances or apparatus to be fitted in a ship as an alternative to that required by the requirements of the Rules, where such fittings, materials, appliances or apparatus are at least as effective as that required by the Rules. However, the authority of the Society is not to extend to substitution of operational methods to effect the control of discharge of oil as equivalent to those design and construction features which are prescribed by the Rules.

2 Notwithstanding the provisions in **1.1.2-1**, the construction and equipment of liquefied gas carriers certified to carry Noxious Liquid Substance listed in **Table N19.1 in Part N of Rules for the Survey and Construction of Steel Ships**, shall be deemed to be equivalent to the construction and equipment requirements contained in **2.2.2, 4.3 and 4.4 of Part 4**, provided that the gas carrier meets all follows condition:

- (1) To be provided with compliance with the requirements of **Part N of Rules for the Survey and Construction of Steel Ships** or the requirements separately provided by the Society;
- (2) To be provided with compliance with the requirements of **Part 4** except **2.2.2, 4.3 and 4.4 of Part 4** for liquefied gas carriers to carry only Noxious Liquid Substance listed in **Table N19.1 of Part N**;
- (3) To be provided with segregated ballast arrangements;
- (4) To be provided with pumping and piping arrangements to ensure Capacity of stripping system in **Table 4-3 of Part 4**;
- (5) To be provided with a Manual for procedures and arrangements for discharge of noxious liquid substances, ensuring that no operational mixing of cargo residues and water will occur and that no cargo residues will remain in the tank after applying the ventilation procedures.

1.1.3 National Requirements

The Society may make special requirements as instructed by the flag-government of ships or the government of sovereign nation in which ships navigate.

1.1.4 Class Notations

1 Based on **2.1.3-2 of the Rules for the Classification and Registry of Ships**, “*Energy Efficiency Design Index-phase X*” (abbreviated as *EEDI-pX* in which *X* refers to the adopted phase) is to be affixed to the classification characters of ships whose attained EEDI satisfies a required value calculated using a phase reduction factor which is stricter than the phase reduction factor to be applied according to **Chapter 3, Part 8**; for ro-ro cargo ships and ro-ro passenger ships, however, this requirement only applies in cases where the required EEDI value is stricter.

2 Based on **2.1.3-2 of the Rules for the Classification and Registry of Ships**, “*Nitrogen Oxides Emission-Tier III*” (abbreviated as “*NOx-III*”) is to be affixed to the classification characters of ships installed with diesel engines satisfying the maximum allowable NOx emission limit criteria specified in **2.1.2-1(1)(c), Part 8** which are permitted to operate in NOx emission control areas. For ships using selective catalytic reduction systems, exhaust gas recirculation systems, dual fuel engines, gas-only engines or other technologies to satisfy the maximum allowable NOx emission limit criteria specified in **2.1.2-1(1)(c), Part 8**, the notations referred to in **(1)** to **(5)** below are listed in parentheses after *NOx-III* according to the type of equipment, engine or technology installed. The purposes (including the technology used in the case of engines referred to in **(5)** below) of engines fitted with the systems referred to in **(1)** or **(2)** below as well as the engines referred to in **(3)**, **(4)** or **(5)** below are to be entered in the Classification Register as descriptive notes for the ship.

(1) Ships using selective catalytic reduction systems complying with **Chapter 21, Part D of the Rules for the Survey and Construction of Steel Ships**:

Selective Catalytic Reduction (abbreviated as “*SCR*”)

(2) Ships using exhaust gas recirculation systems complying with **Chapter 23, Part D of the Rules for the Survey and Construction of Steel Ships**:

Exhaust Gas Recirculation (abbreviated as “*EGR*”)

(3) Ships using dual fuel engines complying with **16.1 and 16.7, Part N of the Rules for the Survey and Construction of Steel Ships** or **1.1.3-1(21), Part GF of the Rules for the Survey and Construction of Steel Ships**:

Dual Fuel Engine (abbreviated as “*DFE*”)

(4) Ships using gas-only engines complying with **1.1.3-1(21), Part GF of the Rules for the Survey and Construction of Steel Ships**:

Gas-only Engine (abbreviated as “*GOE*”)

(5) Ships using technologies other than those described in **(1)** to **(4)** above:

Other Technologies (abbreviated as “*Others*”)

3 With regard to the permission/prohibition of operation of diesel engines in the NOx emission control areas referred to in **1.1.2(15), Part 8 of the Rules**, excluding those case where exemption from compliance with the standards specified in *Regulation 13.5.1 of Annex VI* is granted, the following **(1)** and **(2)** are to be entered into the Classification Register as descriptive notes for the ship.

(1) In the case where diesel engine installations are provided on ships at beginning stage of construction on or after 1 January 2016 (excluding those which fall under the following **(2)**) in accordance with the requirements of *Annex VI*, a note thereof (e.g., *NOx-III(2016)*) is to be added.

(2) In the case where diesel engine installations are provided on ships at beginning stage of construction on or after 1 January 2021 in accordance with the requirements of *Annex VI*, a note thereof (e.g., *NOx-III(2021)*) is to be added.

4 Based on **2.1.3-2 of the Rules for the Classification and Registry of Ships**, “*Sulphur Oxides(Exhaust Gas Cleaning System)*” (abbreviated as “*SOx(EGCS)*”) is to be affixed to the classification characters of ships provided with Exhaust gas cleaning systems approved by the Administration as an alternative specified in **1.1.3, Part 8** that comply with **Chapter 22, Part D of the Rules for the Survey and Construction of Steel Ships**, and that comply with the requirements related to sulphur content specified in **1.2.2-1 or -2, Part 8**, or that are compliance methods at least equivalent to those complying with such requirements. The purposes of machinery fitted with such systems are to be entered into the Classification Register as descriptive notes for the ship.

Chapter 2 TERMINOLOGY AND ABBREVIATIONS

2.1 General

2.1.1 Terminology (Regulation 1 of Annex I and Regulation 1 of Annex II)*

For the purpose of the Rules, the following definitions apply unless otherwise stated in each Part:

- (1) "Oil" means petroleum including crude oil, heavy fuel oil, lubricating oil, light oil, kerosene, gas oil, and others prescribed by the relevant laws and regulations.
- (2) "Oily mixture" means a mixture with any oil content (excluding lubricating oil additives).
- (3) "Liquid substance" means any substance whose vapour pressure (absolute pressure) at 37.8°C does not exceed 0.28MPa.
- (4) "Noxious liquid substance" means any substance assigned as Category X, Y or Z in [Table S17.1](#) and [Table S18.1 in Part S of Rules for the Survey and Construction of Steel Ships](#) or provisionally assessed under the provisions of regulations 6.3 of Annex II of MARPOL 73/78 as falling into Category X, Y or Z.
- (5) "Oil fuel" means any oil used as fuel in connection with the propulsion and auxiliary machinery of the ship in which such oil is carried.
- (6) "Oil tanker" means a ship constructed to carry liquid cargoes in bulk in the greater part of their cargo spaces and a ship constructed to carry liquid cargoes in bulk in part of its cargo spaces with the volume of 200m³ or more (excluding those with cargo spaces which are adapted to exclusively carry cargo other than oil in bulk).
- (7) "Ship carrying noxious liquid substance in bulk" means a ship constructed to carry noxious liquid substances in bulk in the greater part of their cargo spaces, and a ship constructed to carry noxious liquid substances in bulk in part of its cargo spaces (excluding those with cargo spaces which are adapted to exclusively carry cargoes other than noxious liquid substances in bulk).
- (8) "Combination carrier" means a ship designed to carry either oil or solid cargoes in bulk.
- (9) "Segregated ballast" means ballast water introduced into a tank permanently allocated to the carriage of ballast or to the carriage of cargoes other than oil or noxious liquid substances as variously defined in the Rules, and which is completely separated from the cargo system.
- (10) "Length" (L_f) means 96% of the total length on a waterline at 85% of the least moulded depth measured from the top of the keel, or the length from the foreside of the stem to the axis of the rudder stock on that waterline, if that be greater. In ships designed with a rake of keel the waterline on which this length is measured is to be parallel to the designed waterline. The length (L_f) is to be measured in metres.
- (11) "Forward and after perpendiculars" are to be taken at the forward and after ends of the length (L_f). The forward perpendicular is to coincide with the foreside of the stem on the waterline on which the length is measured.
- (12) "Amidships" is at the middle of the length (L_f).
- (13) "Breadth" (B) means the maximum breadth of the ship, measured amidships to the moulded line of the frame in a ship with a metal shell and to the outer surface of the hull in a ship with a shell of any other material. The breadth (B) is to be measured in metres.
- (14) "Deadweight" (DW) means the difference in metric tonnes between the displacement of a ship in water of a specific gravity of 1.025 at the load waterline corresponding to the assigned summer freeboard and the lightweight of the ship.
- (15) "Lightweight" means the displacement of a ship in metric tonnes without cargo, oil fuel, lubricating oil, ballast water, fresh water and feed water in tanks, consumable stores, passengers and their effects.
- (16) "Permeability" of a space means the ratio of the volume within that space which is assumed to be occupied by water to the total volume of that space.
- (17) "Crude oil" means any liquid hydrocarbon mixture occurring naturally in the earth whether or not treated to render it suitable for transportation and includes:
 - (a) crude oil from which certain distillate fractions may have been removed
 - (b) crude oil to which certain distillate fractions may have been added.
- (18) "Volumes" and "areas" in a ship are to be calculated in all cases to moulded lines.

- (19) “Crude oil tanker” means an oil tanker engaged in the trade of carrying crude oil.
- (20) “Product carrier” means an oil tanker engaged in the trade of carrying oil other than crude oil.
- (21) “Equipment for the prevention of discharge of noxious liquid substance” contains prewashing system, stripping system, underwater discharge system, discharge system to a reception facility, ventilated washing system and segregated ballast tanks.
- (22) “A ship which is engaged in the international voyage” means a ship which is engaged in voyage between a port and a port of another country.
- (23) “Residue” means any noxious liquid substance which remains in cargo tanks and in the associated piping after unloading.
- (24) “Anniversary Date” is the day corresponding to the expiry date of the International Oil Pollution Prevention Certificate, excluding expiry date of the Certificate.
- (25) “A ship at beginning stage of construction” is a ship whose keel is laid or a ship at a similar stage of construction. For this purpose, the term “a similar stage of construction” means the stage at which:
- (a) construction identifiable with a specific ship begins; and
 - (b) assembly of that ship has commenced comprising at least 50 tonnes or 1% of the estimated mass of all structural material, whichever is less.
- (26) “Oil residue (sludge)” means the residual waste oil products generated during the normal operation of a ship such as those resulting from the purification of fuel or lubricating oil for main or auxiliary machinery, separated waste oil from oil filtering equipment, waste oil collected in drip trays, and waste hydraulic and lubricating oils.
- (27) “Oil residue (sludge) tank” means a tank which holds oil residue (sludge) from which sludge may be disposed directly through the standard discharge connection or any other approved means of disposal.
- (28) “Oily bilge water” means water which may be contaminated by oil resulting from things such as leakage or maintenance work in machinery spaces. Any liquid entering the bilge system including bilge wells, bilge piping, tank top or bilge holding tanks is considered oily bilge water.
- (29) “Oily bilge water holding tank” means a tank collecting oily bilge water prior to its discharge, transfer or disposal.

2.1.2 Abbreviations

For the purpose of the Rules, the following abbreviations apply.

- (1) *MARPOL 73/78*: The International Convention for the Prevention of Pollution from Ships, 1973, as modified by Protocol of 1978 relating thereto
- (2) *Annex I*: The annex I of *MARPOL 73/78*
- (3) *Annex II*: The annex II of *MARPOL 73/78*
- (4) *Annex IV*: The annex IV of *MARPOL 73/78*
- (5) *Annex VI*: The annex VI of Protocol of 1997 to amend the International Convention for the Prevention of Pollution from Ships, 1973, as modified by the Protocol of 1978 relating thereto
- (6) *A.446 (XI)/A.497 (XII)*: The resolution *A.446 (XI)* amended by *IMO Resolution A.497 (XII)*
- (7) *MEPC.11 (18)*: Guidelines related to inspections on the strength of the *Annex I* of *MARPOL 73/78* (The annex of *MEPC.11 (18)*)
- (8) *SBT*: Segregated Ballast Tank
- (9) *CBT*: Clean Ballast Tank
- (10) *COW*: Crude Oil Washing System
- (11) *IGS*: Inert Gas System
- (12) *PL*: Protective location of segregated ballast space
- (13) *IOPP certificate*: An International Oil Pollution Prevention Certificate
- (14) *EIAPP certificate*: Engine International Air Pollution Prevention Certificate
- (15) *Related laws*: The International Convention for the Prevention of Pollution from Ships, 1973 and laws on the Strength of the Convention
- (16) *IMO*: International Maritime Organization.

Part 2 SURVEYS

Chapter 1 GENERAL

1.1 General

1.1.1 Application

The requirements in this chapter apply to survey and tests for the Marine Pollution Prevention Installations.

1.1.2 Kinds of Surveys

1 Construction and equipment for the prevention of pollution from ships registered or intended to be registered are to subject to the following surveys:

- (1) Surveys for registration (hereinafter referred to as Registration Surveys)

Registration Surveys consist of the following surveys:

- (a) Registration Surveys during Construction
- (b) Registration Surveys not Built under the Survey

- (2) Surveys for maintaining registration (hereinafter referred to as Registration Maintenance Surveys)

Registration Maintenance Surveys consist of the following surveys:

- (a) Periodical Surveys
- (b) Occasional Surveys
- (c) Unscheduled Surveys

- 2 Periodical Surveys consist of the following surveys:

- (1) The construction, equipment and plans specified in **Parts 3 to 6** and **8**:

- (a) Annual Survey
- (b) Intermediate Survey
- (c) Special Survey

- (2) The equipment specified in **Part 7**:

Special Survey

1.1.3 Intervals of Surveys*

- 1 Registration Surveys

- (1) Registration Survey during construction

The Marine Pollution Prevention Installations of ships intended to be constructed and registered with the Society under the survey by the Surveyors in accordance with the designs approved by the Society is to undergo the Registration Survey during construction. The presence of the Surveyor is required at the following stages of the work. The presence of the Surveyor may be increased or decreased taking account of facilities, workmanship and quality control system adopted at the manufacturers or shipyards.

- (a) When materials are applied to the parts and the parts are installed in the Marine Pollution Prevention Installations.
- (b) When machining of the main parts is finished and at a proper time during machining, if necessary.
- (c) When important equipment is installed on board.
- (d) When performance tests are carried out.

- (2) Registration Surveys not Built under the Survey

The Marine Pollution Prevention Installations of ships intended to be registered in a way other than that specified in **(1)** above is to undergo the Registration Surveys not Built under the Survey when an application for the survey is made.

2 Annual Surveys

Annual Surveys are to be carried out at intervals specified in **1.1.3-1(1), Part B of the Rules for the Survey and Construction of Steel Ships**.

3 Intermediate Surveys

Intermediate Surveys are to be carried out at intervals specified in **1.1.3-1(2), Part B of the Rules for the Survey and Construction of Steel Ships**.

4 Special Surveys

Special Surveys are to be carried out at intervals specified in **1.1.3-1(3)(a), Part B of the Rules for the Survey and Construction of Steel Ships**.

5 Occasional Surveys

The classed ships are to be subject to Occasional Surveys when they fall under one of the conditions of **(1)** through **(4)** below. Periodical Surveys may substitute for the Occasional Surveys where the survey items of the Occasional Surveys are inspected as a part of the Periodical Surveys.

- (1) When damage occurred to important parts of the construction or equipment which underwent the Registration Survey, or when repairs or modifications for such damaged parts are carried out.
- (2) When modifications are made to a Shipboard Oil Pollution Emergency Plan, a Shipboard Marine Pollution Emergency Plan for Noxious Liquid Substances, a STS operations Plan and/or a VOC management plan placed on board a ship which underwent the Registration Survey.
- (3) When the Survey for verification of compliance with requirements of the Rules which is to be applied to ships already constructed.
- (4) Other occasions when an Occasional Survey is considered to be necessary.

6 Unscheduled Surveys

The classed ships may be subject to Unscheduled Surveys when the confirmation of the status of the ship by survey is deemed necessary in cases where the Society considers the ship to be subject to **1.4-3** of the **Conditions of Service for Classification of Ships and Registration of Installations**. At Unscheduled Surveys, investigations, examinations or tests are to be made to the satisfaction of the Surveyor with respect to the matters concerned.

1.1.4 Periodical Surveys Carried Out in Advance

The requirements for Periodical Surveys carried out in advance are to be in accordance with the provisions specified in **1.1.4, Part B of the Rules for the Survey and Construction of Steel Ships**.

1.1.5 Postponement of Special Surveys

The requirements for postponement of Special Surveys are to be in accordance with the provisions specified in **1.1.5-1(1)** or **1.1.5-1(2), Part B of the Rules for the Survey and Construction of Steel Ships**.

1.1.6 Modification of the Requirements*

1 With respect to Periodical Surveys in cases where considered appropriate by the Society, the Surveyor may modify the requirements based on the size, service engaged, construction, age, service performance, results of previous surveys and actual condition of the ship.

2 At Intermediate Surveys, where examinations have been carried out during the period between the 2nd and the 3rd Annual Surveys according to the requirements for Intermediate Surveys, said examinations to be carried out as Intermediate Surveys may be omitted at the discretion of the Surveyor.

3 At Intermediate Surveys, as to the items which are considered necessary by the Surveyor or requested by the ship owner, examinations may be carried out according to the requirements for Special Surveys.

4 At Special Surveys, where examinations have been carried out during the period between the 4th Annual Survey and the Special Survey specified in **1.1.3-4** according to the requirements for Special Surveys, said examinations to be carried out as Special Surveys may be omitted at the discretion of the Surveyor. However, in case where Annual Surveys or Intermediate Surveys are carried out in advance in accordance with **1.1.4**, the Special Survey is to be carried out in accordance with the provisions specified otherwise by the Society.

1.1.7 Laid-up Ships

1 Laid-up ships are not subject to Periodical Surveys specified in **1.1.2**. However, Occasional Surveys may be carried out at the request of owners.

2 When laid-up ships are about to be put into service, following surveys and surveys for specific matters which have been postponed due to being laid-up, if any, are to be carried out.

- (1) When any Periodical Survey designated before lay-up has not been due, an equivalent to the Annual Surveys specified in **3.1** is to be carried out.
- (2) When Periodical Surveys designated before lay-up has already become due, these Periodical Surveys are, in principle, to be carried out. However in case where two or more kinds of the Periodical Surveys have already become due, the superlative one is to be carried out.

1.1.8 Unmanned Non-Self-Propelled (UNSP) Barges

Unmanned non-self-propelled barges (UNSP) as defined in **1.1.2(9) in Part 3**, **1.1.2(11) in Part 7** and **1.1.2(27) in Part 8** are not subject to the surveys specified in **1.1.2** for the relevant structures and equipment when exemptions are granted by Administrations.

1.2 Preparation for Surveys and Others**1.2.1 Notification**

When a ship is to be surveyed in accordance with the Rules, it is the responsibility of the owners to notify the Surveyor at the place where they wish to undergo the survey. The Surveyor is to be advised of the survey a reasonable time in advance so that the survey can be carried out at the proper time.

1.2.2 Preparation for Surveys

1 All such preparations as required for registration, periodical and other surveys specified in this part as well as those which may be required by the Surveyor in accordance with the provisions in this Part are to be made by the Owners or their representatives at their responsibilities. The preparations are to include provisions of an easy and safe access, necessary facilities and necessary records for the execution of the survey. Inspection, measuring and test equipment, which Surveyors rely on to make decisions affecting classification are to be individually identified and calibrated to a standard deemed appropriate by the Society. However, the Surveyor may accept simple measuring equipment (*e.g.* rulers, measuring tapes, weld gauges, micrometers) without individual identification or confirmation of calibration, provided they are of standard commercial design, properly maintained and periodically compared with other similar equipment or test pieces. The Surveyor may also accept equipment fitted on board a ship and used in examination of shipboard equipment (*e.g.* pressure, temperature or rpm gauges and meters) based either on calibration records or comparison of readings with multiple instruments.

2 An applicant for survey(s) is to arrange a supervisor who is well conversant with the survey items intended for the preparation of surveys to provide the necessary assistance to the Surveyor according to his requests during the surveys.

1.2.3 Suspension of Surveys

Surveys may be suspended where necessary preparations as specified in **1.1.2-1** have not been made, any appropriate attendant in accordance with **1.1.2-2** is not present, or the Surveyor considers that the safety for execution of the survey is not ensured.

1.2.4 Disposition when Repairs are Considered Necessary as a Result of Surveys

When repairs are considered to be necessary as a result of surveys, the Surveyor notifies his findings to the applicant of surveys. The applicant, when he receives such notification, is to obtain the Surveyor's verification after carrying out the necessary repairs.

1.2.5 Replacement of Fittings, Equipment and Parts, etc.

In cases where it is necessary to replace any fittings, equipment or parts, etc. used onboard, replacements are to comply with the regulations to be applied during ship construction. However, in cases where new requirements are specified or where deemed necessary by the Society, the Society may require that such replacements comply with any new requirements in effect at the time the relevant replacement work is carried out. In addition, replacements are not to use any materials which contain asbestos

1.3 Verification Survey of Certificates, etc.**1.3.1 International Oil Pollution Prevention Certificate, etc. or Equivalent Certificate***

When Annual Surveys and Intermediate Surveys are carried out, the International Oil Pollution Prevention Certificate, the International Pollution Prevention Certificate for the Carriage of Noxious Liquid Substances in Bulk (if required), the International Sewage Pollution Prevention Certificate and the International Air Pollution Prevention Certificate or equivalent Certificates are to be submitted to the Surveyor to obtain his confirmation for the validity of the certificates, with necessary endorsement in them made by him.

1.3.2 Certificates and Documents, etc. other than those Specified in 1.3.1*

1 At surveys, the following certificates and other documents, etc. are to be presented to the Surveyor to verify that these certificates and documents are kept on board the ship (excluding unmanned towed ships) and are appropriate. However, at Occasional Surveys, the presentation of certificates and documents to the Surveyor may be limited to the concerned ones.

- (1) Relating to the installations for the prevention of pollution by oil
 - (a) Certificates of oily-water separating equipment, oil filtering system, processing equipment, oil content meter, oil/water interface detector, oil discharge monitoring and control system, incinerator, flexible hoses used for crude oil washing system and crude oil washing machine, etc. as deemed appropriate by the Society
 - (b) Procedures and Arrangements Manual for the approved crude oil washing system
 - (c) Operation manual for the approved oil discharge monitoring and control system
 - (d) Approved loading manual and damaged stability data
 - (e) Operating and Maintenance manual for oil filtering system (except for ships at beginning stage of construction before 1 January 2005)
 - (f) Operation manual of *CBT*
 - (g) Part flow system operation manual
 - (h) Special ballasting operation manual
 - (i) Records of oil filtering system (except for the Registration Survey and for ships at beginning stage of construction before 1 January 2005)
 - (j) Records of oil discharge monitoring and control system (except for the Registration Surveys)
 - (k) Oil Record Book
 - (l) Shipboard Oil Pollution Emergency Plans
 - (m) STS operations Plan
- (2) Relating to the installations for the prevention of pollution by noxious liquid substances in bulk
 - (a) Approved Procedures and Arrangements Manual for the discharge of noxious liquid substances
 - (b) Cargo record book
 - (c) Shipboard Marine Pollution Emergency Plan for Noxious Liquid Substances
- (3) Relating to the equipment for the prevention of air pollution from ships
 - (a) Bunker delivery note (when the requirements of **1.2.3-2, Part 8** are applied)
 - (b) Technical file (when the requirements of **2.1, Part 8** are applied)
 - (c) Record book of engine parameters or designated electronic record book (when the requirements of **2.1, Part 8** are applied)
 - (d) On-board monitoring manual for on-board direct measurement and monitoring method (when the method referred to in **2.1.2-1(2)(c), Part 8** is used (refer to 6.4 and Appendix VIII of the *NOx Technical Code*))
 - (e) List of equipment containing ozone depleting substances (when the requirements of **1.2.1-5, Part 8** are applied) and Ozone Depleting Substances Record Book (when the requirements of **1.2.1-6, Part 8** are applied)
 - (f) Log-book or designated electronic record book (when the requirements of **2.1.4** or **2.2.1-1, Part 8** are applied)
 - (g) Procedure manual of fuel oil change-over (when the requirements of **2.2.1-1, Part 8** are applied)
 - (h) Operation manual for the vapour collection system and VOC Management Plan (when the requirements of **2.3, Part 8** are applied)
 - (i) Operating manual for the incinerator (when the requirements of **2.4-2, Part 8** are applied)
 - (j) Confirmation of Compliance related to the Ship Energy Efficiency Management Plan (SEEMP) specified in **3.6-5, Part 8**

- (k) Statements of Compliance related to fuel oil consumption reporting and operational carbon intensity rating (when the requirements of **3.7, Part 8** are applied) (All Statements of Compliance are to be kept on board for at least five years.)
- (l) Documents, etc. regarding the exhaust gas cleaning system or other technological methods specified in the following **i)** or **ii)** (for ships where the exhaust gas cleaning systems or other technological methods to which **1.1.3, Part 8** applies are installed or adopted).
 - i) For ships where exhaust gas cleaning systems are installed, manuals such as operation manuals and the EGCS Record Book specified in **2.1.2-1(6)(c)**, records of parameters and a SO_x Emissions Compliance Certificate (if any); or other documents prescribed by the Administration
 - ii) For ships where other technological methods are adopted, approved documentation in respect of the technological methods of achieving compliance with *Regulation 14 of Annex VI*
- (m) A manual for the EGR bleed-off discharge system, an EGR record book, a copy of the certificate for type approval and operating and maintenance manual of the relevant oil content meter, or other documents prescribed by the Administration (when an exhaust gas recirculation system specified in **2.1.1-5, Part 8** is installed).

2 For ships affixed with the notation specified in **1.1.4, Part 1**, the International Energy Efficiency Certificate, the Energy Efficiency Design Index (EEDI) Technical File and the Ship Energy Efficiency Management Plan (SEEMP) are to be submitted to Surveyor during periodical surveys so that it can be verified that they are being properly maintained on board ship and that the information they contain is as required.

1.3.3 Verification Inspection of Related Installations

At surveys, the following items of equipment are to be checked to ensure that they have been inspected in accordance with the requirements of the Rules for the Survey and Construction of Steel Ships.

- (1) *IGS*
- (2) Incinerating equipment

1.4 Other

1.4.1 Remote Surveys*

To implement the survey, in lieu of the traditional ordinary surveys where a surveyor is in attendance, the Society may approve survey methods which it considers to be appropriate.

Chapter 2 REGISTRATION SURVEYS

2.1 Registration Surveys during Construction

2.1.1 General

At Registration Surveys during construction, the Marine Pollution Prevention Installations and their workmanship are to be examined in detail in order to ascertain that they meet the relevant requirements in each Part of the Rules.

2.1.2 Submission of Plans and Documents*

1 For any ship intending to undergo Registration Surveys, the applicable plans and documents specified in (1) to (6) below are to be submitted to the Society for approval. The plans and documents to be approved by the Society are “Plans and Documents for Approval” (hereinafter same in this chapter).

- (1) For ships with the ship’s total volume of oil fuel “C” as defined in **1.2.3-10(10) in Part 3**, of $600m^3$ and above, calculation for the requirements of oil fuel tank protection
- (2) Installations for the prevention of pollution by oils from machinery spaces of all ships
 - (a) Bilge piping diagram
 - (b) Ballast piping diagram
 - (c) Plans and documents relevant to the oil discharge monitoring and control system
 - (d) Plans and documents relevant to the oily-water separating equipment (oil filtering equipment)
 - (e) Plans showing sludge tanks (if included in the bilge piping diagram, no submission of these plans are required)
 - (f) Other plans and documents as deemed necessary by the Society
- (3) Installations for the prevention of pollution by oil carried in bulk by oil tankers
 - (a) Draft and trim calculation sheets for the ship in ballast relevant to marine pollution
 - (b) Calculation for the requirements of arrangement of bulkheads in spaces carrying cargo oils
 - (c) *PL* calculation sheets
 - (d) Damaged stability:
 - i) Damaged stability calculation sheets
 - ii) Loading manual and damaged stability information
 - iii) Stowage plan, draft or trim calculation sheets
 - iv) Arrangement plans for pipes, valves and sea suction.
 - (e) Piping diagrams for each system
 - (f) Retention of oil on board:
 - i) Plans and documents relating to oil discharge monitoring and control system
 - ii) Plans and documents relating to oil/water interface detectors
 - iii) Operation manual of oil discharge monitoring and control system
 - (g) *COW*:
 - i) Plans and documents relating to tank washing machines (Specifications)
 - ii) Shadow diagram
 - iii) Arrangements of hull structural members in tanks
 - iv) Arrangements of drain holes (when entries are made on the midship sectional plan, they may be accepted)
 - v) Arrangements of level gauges and manual sounding openings
 - vi) *COW* operations and equipment Manual
 - (h) *CBT*:
 - i) Arrangement of *CBT*
 - ii) *CBT* operation manual
 - (i) Special ballast:
 - Special ballast operation manual

- (j) Part flow system:
 - Part flow system operation manual
- (k) Other plans and documents as deemed necessary by the Society
- (4) Installations for the prevention of pollution by noxious liquid substances from ships carrying noxious liquid substances in bulk
 - (a) Plans and documents relevant to the pumping system
 - (b) Plans and documents relevant to the prewashing system
 - (c) Plans and documents relevant to the stripping system
 - (d) Plans and documents relevant to the underwater discharge arrangements
 - (e) Plans and documents relevant to the discharge arrangements to reception facilities
 - (f) Plans and documents relevant to the ventilated washing system
 - (g) Procedures and Arrangements Manual for the discharge of noxious liquid substances
 - (h) List of cargoes intended to be carried on board
 - (i) Other plans and documents as deemed necessary by the Society
- (5) Equipment for the prevention of pollution by sewage from ships
 - (a) Plans, documents and particulars relevant to the equipment for the prevention of pollution by sewage from ships (including total capacity of holding tank, total capacity, manufacturer/type and the copy of type approval certificates by the Administration of the sewage treatment plant and the sewage comminuting and disinfecting system)
 - (b) Sewage piping diagrams (including the standard shore connection, arrangement of pipes, valves and their materials)
 - (c) Other plans and documents as deemed necessary by the Society
- (6) Equipment for the prevention of air pollution from ships
 - (a) Ozone depleting substances
 - Plans and documents indicating the location on board and the details of systems, equipment, including portable fire extinguishers, insulation, or other material containing ozone depleting substances, if any, as exceptionally allowed by the requirement of **1.2.1, Part 8**.
 - (b) Nitrogen Oxides (NO_x)
 - Plans and documents relevant to the exhaust gas cleaning system or documents relevant to the method to reduce NO_x emissions, if any. In cases where an exhaust gas recirculation system specified in **2.1.1-5, Part 8** is installed, a manual for the EGR bleed-off discharge system, an EGR record book; or other documents prescribed by the Administration are to be included with the above documents.
 - (c) Sulphur Oxides (SO_x) and Particulate Matter
 - For ships where exhaust gas cleaning systems or other technological methods to which **1.1.3, Part 8** applies are installed or adopted, the plans and documents, etc. specified in the following **i)** or **ii)**:
 - i) For ships where exhaust gas cleaning systems are installed, the plans and arrangements for the system as well as manuals such as operation manuals and the EGCS Record Book of the system; or other documents prescribed by the Administration
 - ii) For ships where other technological methods are adopted, the plans and arrangements for said means
 - (d) Vapour collection system
 - i) Plans and documents (including the operation manual) relevant to the vapour collection system, if any.
 - ii) VOC management plan for crude oil tankers
 - (e) Incinerator
 - Plans and documents relevant to the incinerator (excluding those submitted in accordance with the requirements of **Part D of the Rules for the Survey and Construction of Steel Ships**), if any.
 - (f) Other plans and documents as deemed necessary by the Society
- (7) Others
 - (a) Shipboard Oil Pollution Emergency Plans
 - (b) Shipboard Marine Pollution Emergency Plan for Noxious Liquid Substances

2 The following plans and documents are to be submitted to the Society for reference, in addition to the approval plans and documents specified in the preceding -1.

- (1) Installations for the prevention of pollution by oils from machinery spaces of all ships
 - (a) Particulars of machinery (specifying the capacity of sludge tanks)
 - (b) Other plans and documents as deemed necessary by the Society
- (2) Installations for the prevention of pollution by oil carried in bulk by oil tankers
 - (a) Particulars of hull (specifying the rate of propeller immersion)
 - (b) General arrangement plan
 - (c) Tank capacity plans or tables
 - (d) Plan showing the distribution of light load weight
 - (e) Other plans and documents as deemed necessary by the Society
- (3) Equipment for the prevention of pollution by noxious liquid substances from ships carrying noxious liquid substances in bulk
 - (a) Particulars of hull
 - (b) General arrangement plan
 - (c) Midship section plan
 - (d) Bulkhead construction plan
 - (e) Other plans and documents as deemed necessary by the Society
- (4) Equipment for the prevention of air pollution from ships
 - (a) Operating manual for the incinerator
 - (b) Other plans and documents as deemed necessary by the Society
- (5) Asbestos-free declarations and supporting documents.

3 For ships subject to **Chapter 3, Part 8**, the Energy Efficiency Design Index (EEDI) Technical File and all relevant additional Information are to be submitted to the Society for verification prior to the test specified in **2.1.4-6(2)**. Furthermore, a revised version of the EEDI Technical File based on the results of said test is to be submitted for approval upon completion of the test.

4 For ships subject to **Chapter 3, Part 8**, the Energy Efficiency Existing Ship Index (EEXI) Technical File is to be submitted to the Society for verification prior to the tests specified in **2.1.4-7** (except in cases where the attained EEDI of the ship is equal to or less than the required EEXI). Furthermore, in cases where the ship is provided with a Shaft/Engine Power limitation (SHaPoLi/EPL) system to satisfy **3.5, Part 8**, an Onboard Management Manual (OMM) for SHaPoLi/EPL which meets guidelines deemed appropriate by the Society, as specified in **3.3-4, Part 8**, is to be submitted to the Society for approval.

5 The plans and documents specified in -1 to -4 above are to be submitted the Society in accordance with (1) to (3) below.

- (1) Where the submission of plans and documents by paper, 2 sets for the Society and necessary sets for returning to the applicant are to be submitted.
- (2) Where the submission of plans and documents electrically, the plans and documents are to be submitted using the systems prepared by the Society.
- (3) Where the submission of plans and documents by means other than (1) and (2) above, the plans and documents are to be submitted by the means deemed appropriate by the Society.

2.1.3 Plans and Documents to be Maintained On Board*

At the completion of a classification survey, the plans and documents specified in (1) to (6) below are to be on board.

- (1) The certificates and documents specified in **1.3.2**. The certificates are those such as the ones issued for each piece of equipment, device, etc., type approval certificates valid at the time of the Registration Survey, or others applicable. In addition, unless equipment or devices on board are renewed after the ship has entered service, these certificates need not be updated.
- (2) The Energy Efficiency Design Index (EEDI) Technical File specified in **2.1.2-3**.
- (3) The Ship Energy Efficiency Management Plan (SEEMP) specified in **2.1.5**.
- (4) The Energy Efficiency Existing Ship Index (EEXI) Technical File specified in **2.1.2-4** (except in cases where the attained EEDI of the ship is equal to or less than the required EEXI).
- (5) The Onboard Management Manual (OMM) for ShaPoLi/EPL specified in **2.1.2-4** (in cases where a SHaPoLi/EPL system is installed).

2.1.4 Inspections of Construction and Equipment*

1 Inspections are to be carried out on the items specified in **(1)** to **(4)** below for the installations for the prevention of pollution by oil from the machinery spaces of all ships:

- (1) Equipment to control discharge of oily bilge from machinery spaces (*Regulation 14 of Annex I*)
 - (a) Satisfactory installations and operations of the oily-water separating/filtering system, processing system, and oil content meters are to be ensured. However, the confirmation of operations may be done through simulation tests or equivalent other alternative procedures.
 - (b) Satisfactory installations and operations of the oil discharge monitoring and control system including the automatic and manual operations of the equipment provided for stopping the effluent discharge are to be ensured. However, the confirmation of operations may be done through simulation tests or equivalent other alternative procedures.
 - (c) Satisfactory operations of the indicating and recording devices fitted to the oil discharge monitoring and control system or the oil filtering system are to be ensured.
 - (d) Sufficient provisions of consumables such as recording paper rolls for the recording devices are to be ensured.
 - (e) The satisfactory function of the alarm for the oil filtering system is to be ensured.
 - (f) The automatic stopping device of the oil filtering system is to be tested.
- (2) Fuel oil tanks (*Regulation 16 of Annex I*)
Segregation of oil fuel systems and water ballast systems are to be ensured.
- (3) Tanks for oil residues (*Regulation 12 of Annex I*)
 - (a) Tanks for oil residues (sludge) or bilge water holding tanks, and their discharge arrangements are to be checked to see if they are appropriate.
 - (b) Homogenizers or other approved sludge control equipment are to be checked to see if they function properly. However, the application of this requirement is to be limited to cases where the size of such tanks has been approved in accordance with the requirements of **2.2.1(2) in Part 3 of the Rules**.
- (4) Standard discharge connections (*Regulation 13 of Annex I*)
Satisfactory provisions of the standard discharge connection are to be confirmed.

2 Inspections are to be carried out on the items specified in **(1)** to **(9)** below for the equipment for the prevention of pollution by oil carried in bulk by oil tankers.

- (1) Segregated ballast tanks (*Regulation 18 of Annex I*)
 - (a) Satisfactory installations of the pumps, pipes and valves of the *SBT* system are to be ensured.
 - (b) It is to be ensured that there are no connection between the cargo oil system and segregated ballast system.
 - (c) Where portable spool pieces enabling the segregated ballast tanks to be deballasted in an emergency by connecting such tanks to the cargo oil pump are provided, it is to be confirmed that a check valve is fitted to the segregated ballast pipeline, and that the spool piece is installed at a conspicuous place in the pump room fitted with a permanent sign restricting the use of the spool piece.
 - (d) It is to be confirmed that the ballast pipeline passing the cargo oil tanks and cargo pipeline passing the ballast tanks have no leakage.
- (2) Crude Oil Washing System (*Regulation 33 of Annex I*)
 - (a) It is to be confirmed that the Crude Oil Washing System has been installed in accordance with the requirements of **3.4 in Part 3**, particularly, the following items **i)** through **ix)**:
 - i) Inspection to confirm that the pipes, pumps, valves and deckmounted washing machines give no signs of leakage, and that all of the pipe supports, fasteners, clamps, etc. of the crude washing lines are rigid and intact.
 - ii) The crude oil washing system components are to be tested at a pressure corresponding to 1.5 times the working pressure.
 - iii) Where driving units are not incorporated in the tank washing machines, it is to be ensured that serviceable driving units in the number as specified in the manual are placed on board the ship.
 - iv) Where steam heaters for water washing are provided, it is to be ensured that they can be properly shut-off during crude washing either by double stop valves or by a clearly identifiable blank flange.
 - v) It is to be ensured that the specified means of communication between the on-deck lookout and cargo control room

- is in good working order.
- vi) It is to be ensured that the supply pumps of the crude oil washing system are provided with a safety device for over pressure or other approved equipment.
 - vii) It is to be ensured that the flexible hoses supplying oil to the washing machines of a combination carrier are of the approved type, and that they are stored properly and are ready for service.
 - viii) Operation tests for crude oil washing machines and pumps;
Operation tests for the crude oil washing machines and pumps are to be carried out by using seawater.
 - ix) Performance tests for stripping systems;
Performance tests for the stripping systems are to be carried out during the operation tests specified in **viii)** above.
- (b) The crude oil washing operations are to be carried out using the approved crude oil washing equipment and as specified in the approved Operations and Equipment Manual, and the effectiveness of the crude oil washing system is to be verified to fully comply with the requirements of **3.4 in Part 3** with satisfaction, and, in particular, the items specified in **Table 2-1** are to be confirmed according to the type of ships and the tanks subject to tests and examinations. However, this verification may be carried out within one *year* after the oil tanker was first engaged in the trade of carrying crude oil or by the end of the third voyage carrying crude oil suitable for crude oil washing, whichever occurs later. Where the Society is satisfied that oil tankers are similar in all relevant respects, this requirement needs only be applied to one such oil tanker.
- (3) Retention of Oil on Board (*Regulations 29 and 31 of Annex I*)
- (a) It is to be ensured that the installations of the slop tanks or cargo oil tanks assigned as slop tanks, and related piping systems are in good working order.
 - (b) Inspections of the oil discharge monitoring and control system and associated piping arrangements. Particularly, inspections on the following items:
 - i) It is to be ensured that the oil discharge monitoring and control system including the automatic devices provided to stop effluent discharges, the sampling system, the starting interlocking system, the response time of the oil content meter (to be 20 *seconds* or less) and the accuracy of flow meter ($\pm 10\%$ or less of the actual flow rate) are in good working order. However, confirmation of operations may be done by simulation tests or equivalent other means.
 - ii) It is to be ensured that the indicating and recording devices fitted to the oil discharge monitoring and control system are in good working order.
 - iii) Function tests of audible and visible alarm devices fitted to the oil discharge monitoring and control system.
 - iv) It is to be ensured that consumables for recording devices are sufficiently provided on board the ship.
 - (c) It is to be ensured that the approved oil/water interface detectors are placed on board the ship and are in good working order.
- (4) Pumps, piping and discharge arrangements (*Regulation 30 of Annex I*)
- (a) It is to be ensured that the discharge piping arrangements for the discharge of dirty ballast water or oil contaminated water are satisfactory.
 - (b) It is to be ensured that the observation position and the discharge control position for visually observation of the discharge of oil contaminated water including tests to confirm their satisfactory interconnecting functions are in good order.
 - (c) It is to be ensured that the stripping system, slop tanks, cargo tanks or systems to drain all cargo pumps and all oil lines including interconnecting system for connection to reception facilities for the discharge of dirty ballast water or contaminated water are satisfactory.
- (5) Arrangements (*Regulation 26 of Annex I*)
- It is to be ensured that the cargo transfer system and closing devices provided in the cargo oil pipelines for separating the tanks from each other are appropriate.
- (6) Subdivision and stability (*Regulations 27 and 28 of Annex I*)
- (a) In addition to the arrangements specified in the preceding **(5)**, it is to be ensured that the arrangements to prevent the progressive flooding from extending to compartments are appropriate.
 - (b) Where a stability instrument is fitted on board the ship in accordance with the requirements of 3.2.2, Part 3, it is to be ensured that an operation manual for the instrument is provided on board. Furthermore, it is to be ensured that the

instrument is correctly working by carrying out a functional test after it is installed on board.

(7) Inspection of *CBT* arrangements

- (a) It is to be ensured that the pump, piping and valve arrangements are in accordance with the approved drawings, and they are actually provided and are in good working order.
- (b) Visual inspections of *CBT* to confirm that there is no oil contamination.
- (c) Items specified in the preceding **(1)(d)**.

(8) Special ballasting arrangements

It is to be ensured that the special ballasting arrangements are provided in accordance with the approved drawings and are in good working order.

(9) Part flow system

It is to be ensured that the part flow system is in good working order.

3 Inspections on the items specified in **(1)** to **(5)** below are to be carried out for the equipment for the prevention of discharge by noxious liquid substances from ships carrying noxious liquid substances in bulk:

(1) Prewashing system

- (a) It is to be ensured that the system is provided in accordance with the approved drawings and the procedures and arrangements manual, and is in good working order.
- (b) Where wash water heating system is provided, it is to be ensured that the system is installed in accordance with the approved drawings, and is in good working order.
- (c) Where portable washing machines are used, it is to be ensured that the number and location of opening for tank washing are provided in accordance with the approved drawings.

(2) Stripping system

- (a) It is to be ensured that the stripping system is provided in accordance with the approved drawings, and is in good working order.
- (b) It is to be ensured that the amount of residues produced by stripping, which is determined by the water test through the approved procedure and the approved calculation method is within the values given in **Table 4-3** specified in **4.3.2 in Part 4**.
- (c) Where removable pipes and bent pipes are provided, it is to be ensured that they are stowed on board the ship.

(3) Discharge outlets below the waterline

- (a) It is to be ensured that underwater discharge outlets are provided in accordance with the approved drawings.
- (b) It is to be ensured that means are provided to separate the underwater discharge outlets from those above the water line.

(4) Arrangements for discharge to reception facilities

It is to be ensured that the arrangements for discharge to reception facilities are provided in accordance with the approved drawings, and are in good working order.

(5) Ventilated washing system

- (a) It is to be ensured that the ventilated washing system is provided in accordance with the approved drawings, and is in good working order.
- (b) Where portable washing machines are used, it is to be ensured that the necessary blower fan capacity is obtainable.

Table 2-1 Verification of Effectiveness of Crude Oil Washing System

Type of Ship	Tank	Tests and Examinations
1. For oil tankers that comply with 3.2.4(1)(a) in Part 3	(1) Cargo oil tanks	<p>i) Confirmation of the effectiveness of the stripping system; The operation of the stripping system is to be confirmed by observing the monitoring devices and monitoring the oil level (by dipping or other means) specified in 3.4.5(6) in Part 3 during bottom washing.</p> <p>ii) Confirmation of the proper operation of the crude oil washing machines and pumps; The proper operation of washing machines is to be monitored with particular reference to supply pressure, cycle times, machine function (the operating indicators and sound patterns) or by other approved methods.</p> <p>iii) Confirmation of the condition of the bottom of cargo tanks after washing; On completion of washing and final draining, the tanks are to be hand dipped, as close as practical to the forward end, centre and aft end in each tank to confirm that the bottom of each cargo tank is dry*¹. The record of these dips is to be made in Operations and Equipment Manual.</p> <p>iv) The tests and examinations specified in i) through iii) above may need only be applied to one tank of a group of tanks of similar configuration.</p> <p>v) Internal examinations of the tanks are to be carried out if deemed necessary by the Surveyor.</p>
2. For oil tankers other than those specified in 1 above	(1) Cargo oil tanks	i) Same requirements as specified in 1(1) above
	(2) Cargo oil/Gale ballast tanks	<p>i) Same requirements as specified in 1(1) above</p> <p>ii) Confirmation of oil floating on top of ballast water; A measurement is to be made of the amount of oil floating on top of the gale ballast to confirm that the ratio of the volume of oil on top of the total gale ballast water to the volume of tanks that contain this water is not to exceed 0.00085.</p>

Note: *1 The term of “dry”: **3.4.5(4) in Part 3** is to be referred to

4 Inspections are to be carried out on the items specified in **(1) to (3)** below for the equipment for the prevention of pollution by sewage from ships:

- (1) It is to be ensured that the equipment is provided in accordance with the approved drawings.
- (2) It is to be ensured that the discharge pipeline and the standard discharge connection specified in **2.2.1, Part 7** are provided in accordance with the approved drawings.
- (3) It is to be ensured that the equipment in **(1)** and the pumps relevant to **(2)** are in good working order.

5 Inspections are to be carried out on the items specified in **(1) to (6)** below for the equipment for the prevention of air pollution from every ship of 400 tons gross tonnage or above, every mobile offshore drilling unit and other platforms. However, the inspections required in **(2)(b)** and **(3)** excluding **(a)** are to be carried out irrespective of tonnage of the ship.

- (1) Ozone depleting substances
 - (a) It is to be confirmed which systems or equipment, including portable fire extinguishers, on board the ship contain hydro-chlorofluorocarbons (HCFCs).

(b) It is to be ensured that the systems and equipment referred to in (a) are in good working order and there are no emissions of hydro-chlorofluorocarbons (HCFCs).

(2) Sulphur Oxides (SO_x) and Particulate Matter

(a) It is to be ensured that the system for fuel-changeover operation is in good working order.

(b) For ships where exhaust gas cleaning systems or other technological methods to which **1.1.3, Part 8** applies are installed or adopted, the following surveys of said systems or methods are to be carried out.

- i) Examinations of work, such as installation, etc.
- ii) Performance tests

(3) Nitrogen Oxides (NO_x)

The following emission testing, examination and survey specified in (a) and (b), and the survey for diesel engines equipped with an exhaust gas recirculation system specified in **2.1.1-5, Part 8** specified in (c) are to be carried out in accordance with the *NO_x Technical Code* for every individual diesel engine to which the requirements of **2.1, Part 8** are applied.

(a) For diesel engines deemed necessary by the Society, it is to be verified that NO_x emissions are within the limits specified in **2.1.2-1, Part 8** in accordance with the on-board NO_x verification procedures contained in the approved Technical File. The procedures are to be the on-board simplified measurement method referred to in **2.1.2-2(2)(b), Part 8** or the parameter check method referred to in **2.1.3-1(4), Part 8**. A part of the tests may be omitted where deemed appropriate by the Society and there are two or more diesel engines in an Engine Family or Engine Group or two or more cylinders of the same particulars on board the ship. However, the tests are to be completed for at least one of those diesel engines, and/or one of those cylinders. As an alternative to the examination of fitted components, the Society may accept conducting that part of the survey on spare parts carried on board provided they are representative of the components fitted to the diesel engine.

(b) For diesel engines whose NO_x emissions have been verified without a NO_x-reducing device in accordance with 2.2.5.1 of the *NO_x Technical Code* when the measurement procedures for emission verification on a test bed referred to in **2.1.2-2(2)(a), Part 8** are applied, an onboard survey is to be carried out in accordance with a standard deemed appropriate by the Society.

(c) For EGR bleed-off water discharge arrangements, the following surveys are to be carried out:

- i) Confirmation of installation, etc.; and
- ii) Performance test

(4) Vapour collection system

(a) It is to be ensured that the vapour collection system is installed in accordance with the approved drawings and documents.

(b) It is to be ensured that the vapour collection system, including the liquid level gauging devices, high liquid level alarms and alarms provided with the pressure gauges, is in good working order.

(5) Incinerator

(a) It is to be ensured at the manufacturing plant, etc. by the tests otherwise specified by the Society that all parts of the incinerator, including controls and safety devices, are in good working order.

(b) It is to be ensured that the incinerator is installed in accordance with the approved drawings and documents.

(c) It is to be ensured on board by the tests otherwise specified by the Society that all parts of the incinerator, including controls and safety devices, are in good working order.

(6) Representative sample (in-use samples) position of fuel oil to be used (limited to ships of 400 *gross tonnage* and above that are engaged in international voyages)

Confirmation that positions for representative sample (in-use samples) of fuel oil are fitted or designated.

6 For ships subject to **Chapter 3, Part 8**, inspections related to Energy Efficiency Design Index (EEDI) are to be carried out in accordance with (1) and (2) below.

(1) Verification at the design stage

Tank tests are to be carried out and the EEDI calculated from the power curve (correlation between speed and engine output) obtained from the results of tank tests and principle particulars of the ship is to be verified. However, such tank tests may be omitted in cases deemed appropriate by the Society. In such cases, the EEDI calculated from the power curve obtained from available data, etc. as well as the principle particulars of the ship is to be verified.

(2) Verification at sea trials

Confirmation of speed test measurements and the verification of the final calculated value of attained EEDI are to be carried out.

7 For ships subject to **Chapter 3, Part 8**, the Energy Efficiency Existing Ship Index (EEXI) is to be verified. In cases where the ship is provided with a Shaft/Engine Power Limitation (SHaPoLi/EPL) system to satisfy **3.5, Part 8**, the Surveyor is to confirm that the system is appropriately installed and sealed in accordance with guidelines deemed appropriate by the Society, as specified in **3.3-4, Part 8**, and a verified Onboard Management Manual (OMM) for SHaPoLi/EPL is maintained on board.

8 For the tests specified in **-1, -2, and -6** the applicant is to prepare test plans for review by the Society prior to testing. In addition, test records and/or measurement records are to be submitted to the Society as required.

9 Materials which contain asbestos are not being used for the items specified in (1) to (5) above.

2.1.5 Inspections of Ship Energy Efficiency Management Plans (SEEMP)

It is to be confirmed that the Ship Energy Efficiency Management Plan (SEEMP) is in accordance with **3.6, Part 8**.

2.2 Registration Surveys Not Built under the Survey**2.2.1 General**

At Registration Surveys not Built under the survey, inspections are to be carried out on the Marine Pollution Prevention Installations, and it to be complied with the requirements specified in the Rules.

2.2.2 Submission of Plans and Documents

For any ships intending to undergo Registration Surveys not Built under the survey, the plans and documents specified in **2.1.2 in Part 2** are to be submitted according to the necessities.

2.2.3 Plans and Documents to be Maintained On Board

At the completion of a registration survey, the Surveyor confirms that certificates and documents specified in **2.1.3** are on board.

2.2.4 Inspection of Construction and Equipment

At Registration Surveys not Built under the survey, the relevant inspections mutatis mutandis the requirements specified in **2.1.4** are to be carried out. However, for ships in possession of the International Oil Pollution Prevention Certificate, the International Pollution Prevention Certificate for the Carriage of Noxious Liquid Substances in bulk (if required), the International Sewage Pollution Prevention Certificate and the International Air Pollution Prevention Certificate or equivalent Certificates, inspections corresponding to that specified in **3.3** are to be carried out.

2.2.5 Inspections of Ship Energy Efficiency Management Plans (SEEMP)

Ship Energy Efficiency Management Plan (SEEMP) is to be satisfied with **3.6, Part 8**.

Chapter 3 REGISTRATION MAINTENANCE SURVEYS

3.1 Annual Surveys

3.1.1 General

At Annual Surveys, inspections are to be carried out on the relevant items of the requirements specified in 3.1.2 of the Rules, and in addition, general conditions of the relevant construction and equipment are to be inspected.

3.1.2 Inspections of Construction and Equipment*

1 The following inspections are to be carried out on the equipment for the prevention of pollution by oil from machinery spaces of all ships:

- (1) Equipment to control discharge of oily bilge from machinery spaces (*Regulation 14 of Annex I*)
 - (a) Visual inspections of the oily-water separating equipment, oil filtering system, processing system and oil content meters
 - (b) Visual inspection of the oil discharge monitoring and control system
 - (c) It is to be ensured of satisfactory operations of the automatic or manual means to stop discharge of effluent fitted to the oil discharge monitoring and control system.
 - (d) It is to be ensured of satisfactory operations of the indicating and recording devices of the oil discharge monitoring and control system or the oil filtering system, and sufficient provisions of consumables for the recording devices on board the ship.
 - (e) Alarm test of the oil filtering system
 - (f) Test of the automatic stopping device of the oil filtering system
 - (g) Verification of the calibration certificates of the oil filtering equipment to which Res. *MEPC.107(49)*, as amended, applies (if a 15 ppm alarm is fitted)
- (2) Fuel oil tanks (*Regulation 16 of Annex I*)

It is to be ensured of segregation of the oil fuel system and water ballast system.
- (3) Tanks for oil residues (*Regulation 12 of Annex I*)
 - (a) It is to be ensured that the tanks for oil residues, slop tanks and their discharge arrangements are satisfactory.
 - (b) It is to be ensured that the homogenizers or other approved equipment for the control of oil residues (sludge) are in good working order.

However, this requirement is to apply only where the size of the tanks for oil residues (sludge) is approved in accordance with the requirements of **2.2.1-1(2) in Part 3 of the Rules**.
- (4) Standard discharge connections (*Regulation 13 of Annex I*)

It is to be ensured of the provision of the standard discharge connection.

2 Inspections are to be carried out on the following items for the construction and equipment for the prevention of pollution by oil carried in bulk by oil tankers.

- (1) Segregated ballast tanks (*Regulation 18 of Annex I*)
 - (a) It is to be ensured that there are no connections between the cargo oil pipelines and ballast pipelines.
 - (b) Where portable spool pieces enabling the segregated ballast tanks to be deballasted in an emergency by connecting such tanks to the cargo oil pump are provided, it is to be ensured that a check valve is fitted to the segregated ballast pipeline and that a permanent sign restricting the use of the spool piece is fitted to a conspicuous place in the pump room.
 - (c) It is to be ensured that there is no sign of oil contamination in the segregated ballast tanks.
- (2) Crude oil washing system (*Regulation 33 of Annex I*)

It is to be ensured that the requirements of the crude oil washing system are satisfactory, and in particular, inspections are to be carried out on the following items (a) through (f):

 - (a) Visual inspection to ensure that there is no indication of leakage on crude washing pipelines, pumps, valves and deck-mounted washing machines, and that all of the fasteners of crude washing pipelines are intact.
 - (b) Where driving units are not incorporated in the tank washing machines, it is to be ensured that serviceable driving units in

number as specified in the manual are provided on board the ship.

- (c) Where steam heaters for water washing are provided, it is to be ensured that they can be properly shut-off during crude oil washing either by the double stop valve or by the clearly identifiable blank flange.
- (d) It is to be ensured that the specified means of communication between the on-deck lookout and cargo control room is in good working order.
- (e) It is to be ensured that the supply pumps of the crude oil washing system are provided with a safety device for overpressure or other approved devices.
- (f) It is to be ensured that the flexible hoses supplying oil to the washing machines of combination carriers are of the approved type, and that they are stored properly and are ready for service.

(3) Retention of oil on board (*Regulations 29 and 31 of Annex I*)

- (a) Inspection of the oil discharge monitoring and control system and associated piping arrangements, particularly, inspections on the following items:
 - i) Visual inspection of the oil discharge monitoring and control system and associated equipment.
 - ii) It is to be ensured that the automatic and manual devices provided to stop effluent discharges are in good working order.
 - iii) It is to be ensured that the indicating and recording devices are in good working order, and that consumables for recording devices are sufficiently provided on board the ship.
 - iv) Function tests of audible or visible alarm devices fitted to the oil discharge monitoring and control system.
- (b) It is to be ensured that the approved oil/water interface detectors are stowed on board the ship.

(4) Pumps, piping and discharge arrangements (*Regulation 30 of Annex I*)

- (a) It is to be ensured that the discharge piping arrangements for discharge of dirty ballast water or oil contaminated water are satisfactory.
- (b) Tests on the means of communication between the observation position and the discharge control position.
- (c) Inspection of the stripping system, slop tanks, cargo tanks or systems to drain all cargo pumps and all oil lines including inter connecting pipelines to reception facilities for discharge of dirty ballast water or contaminated water.

(5) *CBT* arrangements

- (a) It is to be ensured that the *CBT* arrangements are in good working order.
- (b) Visual inspection of *CBT* to ensure that there is no sign of contamination by oil.

(6) Special ballast system

It is to be ensured that the special ballast system is in good working order.

(7) Part flow system

It is to be ensured that the part flow system is in good working order.

(8) STS operations Plan (*Regulation 41 of Annex I*)

For oil tankers of 150 gross tonnage and above engaged in the transfer of oil cargo between oil tankers at sea, it is to be ensured that a STS operations Plan approved by the Society is provided on board.

(9) Stability instrument (*Regulation 28 of Annex I*)

Where a stability instrument is fitted on board the ship in accordance with the requirements of **3.2.2, Part 3**, it is to be ensured that the instrument is correctly working by carrying out a functional test.

3 Inspections are to be carried out on the following items for the equipment of the ships for the prevention of pollution by noxious liquid substances in bulk:

(1) Prewashing system

- (a) Visual inspection to confirm that the type, capacity, number and locations of washing machines are as approved.
- (b) Visual inspection of the tank washing pipelines and wash water heaters.

(2) Stripping system

Visual inspection to confirm that no modifications have been made on any part of the stripping system

(3) Discharge outlets below the waterline

Visual inspection of the location of the underwater discharge outlets as far as practicable

(4) Arrangements for discharge to reception facilities

Visual inspection

(5) Ventilated washing system

It is to be confirmed that the ventilating equipment is of the approved type.

4 Inspections are to be carried out on the following items for the equipment for the prevention of air pollution from every ship of 400 *gross tonnage* and above, every mobile offshore drilling unit and other platforms. The surveys referred to in **(3)(b)** is, however, to be carried out on all ships.

(1) Ozone depleting substances

It is to be confirmed which systems or equipment, including portable fire extinguishers, on board the ship contain ozone depleting substances, in addition, they are to be visually inspected.

(2) Fuel oil

It is to be ensured that bunker delivery notes accompanied by representative samples of the fuel oil delivered are retained appropriately.

(3) Sulphur Oxides (SO_x) and Particulate Matter

(a) It is to be ensured that the system for fuel-changeover operation is in good working order.

(b) For ships where exhaust gas cleaning systems or other technological methods to which **1.1.3, Part 8** applies are installed or adopted, surveys of the said systems or methods are to be carried out.

(4) Nitrogen Oxides (NO_x)

(a) For every diesel engine to which the requirements of **2.1, Part 8** are applied, it is to be verified that the exhaust gas cleaning system to reduce NO_x emissions has been installed or the method to reduce NO_x emissions has been carried out in accordance with the approved drawings and/or documents.

(b) For every diesel engine to which the requirements of **2.1, Part 8** are applied, it is to be verified that NO_x emissions are within the limits specified in **2.1.2-1, Part 8** in accordance with the on-board NO_x verification procedures contained in the approved Technical File. The procedures followed are to be the same as either the on-board simplified measurement method referred to in **2.1.2-2(b), Part 8**, the on-board direct measurement and monitoring method referred to in **2.1.2-2(c), Part 8** or the parameter check method referred to in **2.1.3-1(4), Part 8**.

(c) For ships equipped with the exhaust gas recirculation system specified in **2.1.1-5, Part 8** the following surveys for EGR bleed-off water discharge arrangements:

- i) General examination, and
- ii) Performance test

(5) Vapour collection system

(a) It is to be ensured that the vapour collection system has been installed in accordance with the approved drawings and documents and is in good order.

(b) It is to be ensured that the vapour collection system, including the liquid level gauging devices, high liquid level alarms and alarms provided with the pressure gauges, is in good working order.

(6) Incinerator

(a) It is to be ensured that the incinerator has been installed in accordance with the approved drawings and documents and is in good order.

(b) Performance tests are to be carried out.

(7) Representative sample (in-use samples) position of fuel oil to be used (limited to ships of 400 *gross tonnage* and above that are engaged in international voyages)

Confirmation that positions for representative sample (in-use samples) of fuel oil are fitted or designated.

5 It is to be verified that a Shipboard Oil Pollution Emergency Plan and/or a Shipboard Marine Pollution Emergency Plan for Noxious Liquid Substances are/is placed on board the ship and in compliance with the requirements of **Part 5** and **Part 6**.

3.2 Intermediate Surveys

3.2.1 General

At Intermediate Surveys, inspections are to be carried out on the relevant items of **3.2.2** of the Rules, and in addition, general condition of the relevant construction and equipment are to be inspected.

3.2.2 Inspections of Construction and Equipment*

1 In addition to inspections specified in **3.1.2-1** of the Rules on the equipment for the prevention of pollution by oil from machinery spaces of all ships, inspections are to be carried out on the following items:

- (1) It is to be ensured that the oily-water separating equipment, oil filtering system, processing equipment and oil content meters are in good working order. However, the confirmation of functions may be made by with simulation test or equivalent other methods.
- (2) Where oily-water separating equipment, oil filtering system or processing equipment is provided, inspections are to be carried out on the equipment including the wear of associated pumps, piping and fittings.
- (3) It is to be ensured that the oil discharge monitoring and control system including the function of the automatic or manual means for stopping discharge of effluent are in good working order. However, confirmation of function may be made by simulation tests or equivalent other methods.
- (4) Examining the oil content meters (15ppm alarm and oil discharge monitoring and control equipment for bilge) for obvious defects, deterioration or damage; and confirmation of the calibration of the oil content meters (excluding 15 ppm alarms of the oil filtering equipment to which Res. MEPC.107(49), as amended, applies) in the presence of the Surveyor or checking the record of calibration of such meters when done in accordance with the manufacturer's operational and instruction manual

2 The following inspections are to be carried out on the equipment for the prevention of pollution by oil carried in bulk by oil tankers, in addition to the inspection items specified in **3.1.2-2** of the Rules:

- (1) Crude oil washing system (*Regulation 33 of Annex I*)
 - (a) Inspection of crude oil washing pipelines provided outside cargo oil tanks. Where the inspection results are in doubt on their conditions, pressure tests or pipe thickness gauging or both of them are to be carried out. Particular attention is to be paid to areas provided with a doubler by welding.
 - (b) It is to be ensured that the shut-off valves for the steam heaters of wash water are in good working order.
 - (c) The effectiveness of the crude oil washing system is to be verified to fully comply with the requirements of **3.4 in Part 3** with satisfaction, and, in particular, the items specified in **Table 2-2** are to be confirmed according to the type of ships and the tanks subject to tests and examinations.

Table 2-2 Verification of Effectiveness of Crude Oil Washing System

Type of Ship	Tank	Tests and Examinations
1. For oil tankers that comply with 3.2.4(1)(a) in Part 3	(1) Cargo oil tanks	The tests and examinations required for the tanks specified in 1(1) in Table 2-1 are to be carried out at least on two selected cargo oil tanks. The operation test may be carried out during crude oil washing, water washing or in dock.
2. For oil tankers other than those specified in 1 above	(1) Cargo oil tanks	i) Same requirements as specified in 1(1) above
	(2) Cargo oil/Departure ballast tanks	i) Same requirements as specified in 1(1) above ii) Confirmation of oil floating on top of ballast water; A measurement is to be made of the amount of oil floating on top of the departure/gale ballast to confirm that the ratio of the volume of oil on top of the total departure/gale ballast water to the volume of tanks that contain this water is not to exceed 0.00085. This measurement may need only be applied to one tank of a group of tanks of similar configuration.
	(3) Cargo oil/Gale ballast tanks	
	(4) Cargo oil/Arrival ballast tanks	i) Same requirements as specified in 1(1) above ii) Confirmation of the oil content of ballast water; The arrival ballast is to be totally discharged through the oil discharged monitoring and control system to confirm that the oil content of the effluent in this test is not to exceed 15ppm. This measurement may need only be applied to one tank of a group of tanks of similar configuration.

(2) Inspection of oil discharge monitoring and control equipment and the associated piping arrangements

- (a) It is to be confirmed that the installations of the oil discharge monitoring and control system are satisfactory and are in good working order including the automatic or manual stopping devices for the discharge of effluent, the sampling system, the starting interlock system and the confirmation of the response time of oil content meters (within 20 seconds). The confirmation of function may be conducted by simulation tests or by other equivalent methods.
 - (b) Inspections to identify apparent defects or deterioration or damage of the oil discharge monitoring and control system and oil content meters, and where the confirmation on corrections of oil content meters in the presence of the Surveyor were carried out in accordance with the manufacturer's operation or service manual, the records of corrections are to be confirmed.
- (3) Confirmation of function of the valves of individual cargo oil tanks, which are to be closed while the ship is at sea, or other similar closing appliances when they are operated manually or remote controlled.
- (4) Confirmation of satisfactory operation of oil/water interface detectors

3 The following inspections are to be carried out on the equipment for the prevention of pollution by noxious liquid substances from ships carrying noxious liquid substances in bulk, in addition to the inspections specified in 3.1.2-3 of the Rules.

(1) Prewashing system

It is to be ensured that the prewashing system is serviceable. However, when this is impracticable, confirmation may be done only by examining the cargo record book.

(2) Stripping system

It is to be ensured that the stripping system is in good working order, and the stripping system is operated effectively with the cargo record book.

(3) It is to be ensured that the underwater discharge outlets are in good order.

(4) Arrangements for discharge to reception facilities

It is to be ensured that the arrangements for discharge to reception facilities are serviceable.

(5) Ventilated washing system

It is to be ensured that the ventilated washing system is serviceable.

4 Inspections specified in **3.1.2-4** are to be carried out on the equipment for the prevention of air pollution from every ship of 400 *gross tonnage* and above, every mobile offshore drilling unit and other platforms except where all ships are to be subjected to the surveys referred to in **3.1.2-4(3)(b)**.

5 It is to be verified that a Shipboard Oil Pollution Emergency Plan and/or a Shipboard Marine Pollution Emergency Plan for Noxious Liquid Substances are/is placed on board the ship and in compliance with the requirements of **Part 5** and **Part 6**.

3.3 Special Surveys

3.3.1 General

At Special Surveys, general conditions of the relevant construction and equipment are to be inspected in addition to the relevant items specified in **3.3.2** of the Rules.

3.3.2 Inspections of Construction and Equipment*

1 Inspections specified in **3.2.2-1** of the Rules are to be carried out on the equipment for the prevention of pollution by oil from machinery spaces of all ships.

2 The following inspections are to be carried out in addition to those specified in **3.2.2-2** of the Rules on the equipment for the prevention of pollution by oil carried in bulk by oil tankers:

(1) Segregated ballast tanks (*Regulation 18 of Annex I*)

(a) It is to be ensured that the pumps, piping and valve arrangements are in accordance with the requirements for the *SBT* arrangements.

(b) Inspections on the wear of pumps, pipes and valves

(c) It is to be ensured that there is no leakage in the ballast pipelines passing cargo oil tanks and the cargo oil pipelines passing ballast tanks.

(2) Crude oil washing system (*Regulation 33 of Annex I*)

(a) It is to be ensured that the crude oil washing system is in accordance with the approved plans and the requirements of **3.4 in Part 3** of the Rules. In particular, the following items **i)** through **iv)** are to be confirmed:

i) Open up inspection of pumps.

ii) Pressure test of the crude oil washing system at the working pressure.

iii) It is to be ensured through internal inspection of cargo oil tanks that the equipment and devices in cargo oil tanks are in good working order.

iv) Where provided, the double stop valve for properly shutting off the lines to steam heaters for water washing is to be subjected to an open up inspection.

(b) Items specified in the preceding **(1)(c)**.

(3) Retention of oil on board (*Regulations 29 and 31 of Annex I*)

It is to be ensured that slop tanks, cargo oil tanks assigned as slop tanks and the associated piping arrangements are in good working order and the accuracy of flow meters is within those specified elsewhere.

(4) Pumps, piping and discharge arrangements (*Regulation 30 of Annex I*)

It is to be ensured that the pumps, piping and discharge arrangements for discharge of dirty ballast water or oil-contaminated water are satisfactory.

(5) *CBT* arrangement

Items specified in the preceding **(1)(c)**.

3 Inspections on the following items are to be carried out on the equipment for the prevention of discharge of noxious liquid substances from ships carrying noxious liquid substances in bulk in addition to the inspections specified in **3.2.2-3** of the Rules:

(1) Prewashing system

Inspection on the wear of the pumps serving prewashing system, washing machines and wash water heaters

(2) Stripping system

- (a) Water tests to confirm the amount of residues from stripping are to be carried out on the stripping system and the associated pumps by selecting at least two cargo oil tanks. Similar tests may be carried out on other cargo oil tanks as deemed necessary.
- (b) Inspection on the wear of the associated pumps and piping arrangements.

(3) Discharge outlets below the waterline

Inspection on the wear of the underwater discharge outlets (including the associated pumps and piping arrangements and discharge valves)

(4) Arrangements for discharge to reception facilities

Inspection on the wear of the pumping and piping arrangements

(5) Ventilated washing system

Inspection to confirm wear of the ventilation equipment and piping arrangement

4 Inspections on the following items are to be carried out on the equipment for the prevention of pollution by sewage from ships:

- (1) It is to be ensured that the equipment is provided in accordance with the approved drawings.
- (2) It is to be ensured that the discharge pipeline and the standard discharge connection specified in **2.2.1, Part 7** are provided in accordance with the approved drawings.
- (3) It is to be ensured that the equipment in **(1)** and the pumps relevant to **(2)** are in good working order.
- (4) Inspection on the wear of the associated pumps and piping arrangements.

5 Inspections specified in **3.2.2-4** are to be carried out on the equipment for the prevention of air pollution from every ship of 400 *gross tonnage* and above, every mobile offshore drilling unit and other platforms except where all ships are to be subjected to the surveys referred to in **3.1.2-4(3)(b)**.

6 It is to be verified that a Shipboard Oil Pollution Emergency Plan and/or a Shipboard Marine Pollution Emergency Plan for Noxious Liquid Substances are/is placed on board the ship and in compliance with the requirements of **Part 5** and **Part 6**.

Chapter 4 OCCASIONAL SURVEYS

4.1 General

4.1.1 Application

The requirements in this chapter apply where the equipment for the prevention of pollution in ships has been conversed, repaired or modified, or where the Shipboard Oil Pollution Emergency Plan and/or the Shipboard Marine Pollution Emergency Plan for Noxious Liquid Substances have/has been modified.

4.1.2 Inspection*

Occasional Surveys listed in [1.1.3-5\(1\)](#) and [\(2\)](#) are to be carried out in a manner mutatis mutandis the Special Surveys on the Marine Pollution Prevention Installations according to the extent of modifications or repairs.

Part 3 CONSTRUCTION AND EQUIPMENT FOR THE PREVENTION OF POLLUTION BY OIL

Chapter 1 GENERAL

1.1 Application and Terminology

1.1.1 Application*

1 The requirements in this chapter apply to the construction and equipment for the prevention of pollution by oil from ships.

2 The requirements of 1.2.3 are to apply to ships with an aggregated oil fuel capacity of “C” as defined in 1.2.3-10(10), of 600m³ and above:

- (1) for which the building contract is placed on or after 1 August 2007, or
- (2) in the absence of a building contract, which are at beginning stage of construction on or after 1 February 2008, or
- (3) the delivery of which is on or after 1 August 2010, or
- (4) which have undergone a major conversion:
 - (a) for which the contract is placed after 1 August 2007,
 - (b) in the absence of a contract, the construction work of which is begun after 1 February 2008, or
 - (c) which is completed after 1 August 2010.

3 For ships of oil tankers designed to have the construction carrying liquid cargo in bulk in part of cargo oil tanks, the requirements relevant to oil tankers specified in 1.2.1, 2.3.2, 3.2.1(4)(b), 3.3.1-1, 3.3.1-3 through 3.3.1-8, and 3.3.2-1 through 3.3.2-4 of the Rules apply to the construction of such cargo spaces. However, where the total volume of the cargo spaces is less than 1,000m³, the requirements of 3.3.1-2 of the Rules may be applied in place of the requirements of 3.3.1-1 and 3.3.1-3 through 3.3.1-8 of the Rules.

4 Fixed or floating platforms including drilling rigs, floating production, storage, and offloading facilities (*FPSOs*) used for the offshore production and storage of oil, floating storage units (*FSUs*) used for the offshore storage of produced oil are to comply with the following.

- (1) Fixed or floating drilling rigs when engaged in the exploration, exploitation and associated offshore processing of sea-bed mineral resources and other platforms are subject to the provisions for ships of 400 *gross tonnage* and above other than oil tankers, except for the following (1) and (2):
 - (a) They are to be equipped as far as practicable with the installations required in 2.2.1, 2.2.2, 2.3 and 2.4.
 - (b) They are to keep a record of all operations involving oil or oily mixture discharges, in a form approved by the Society.
- (2) Platforms configured as *FPSOs* or *FSUs* are to comply with other guidelines deemed appropriate by the Society in addition to -4(1) above.

5 For all hydrofoils, air cushion craft, and other new types of ships (ships proceeding near the sea surface, and ships proceeding under the sea surface, etc.) the application of the requirements in Chapter 2 and Chapter 3 concerning the construction and equipment to which is structurally not reasonable or impossible, they may not be applied. However, this relaxation is conditional that equivalent arrangements have been made on the construction and equipment for the prevention of pollution of these ships in consideration of the purpose of service.

6 Notwithstanding the preceding of -1 to -5, ships not engaged in international voyages are to be dealt with as deemed appropriate by the Society.

7 With regard to conversions from single hull oil tankers to bulk carriers, the requirements in effect at the date of conversion are to be complied with.

8 For unmanned non-self-propelled (UNSP) barges, the following 1.2.1, 1.2.2, 1.2.3, 2.2, 2.3 and 2.4 need not be applied when exemptions are granted by Administrations.

1.1.2 Terminology (Regulation 1 of Annex I)*

For the purpose of the requirements in this part, the following definitions apply:

- (1) “Clean ballast” means the ballast in a tank which since oil was last carried therein, has been so cleaned that effluent therefrom if it were discharged from a ship which is stationary into clean calm water on a clear day would not produce visible traces of oil on the surface of the water or on adjoining shorelines or cause a sludge or emulsion to be deposited beneath the surface of the water or upon adjoining shorelines. If the ballast is discharged through an oil discharge monitoring and control system approved by the Administration, evidence based on such a system to the effect that the oil content of the effluent did not exceed 15ppm shall be determinative that the ballast was clean, notwithstanding the presence of visible traces.
- (2) “Special area” means a sea area where for recognized technical reasons in relation to its oceanographical and ecological condition and to the particular character of its traffic the adoption of special mandatory methods for the prevention of sea pollution by oil is required. Special area is specified in Regulation 1.11 of Annex I.
- (3) “Instantaneous rate of discharge of oil content” means the rate of discharge of oil in litres per hour at any instant divided by the speed of the ship in knots at the same instant.
- (4) “Tank” means an enclosed space which is formed by the permanent structure of a ship and which is designed for the carriage of liquid in bulk.
- (5) “Wing tank” means any tank adjacent to the side shell plating.
- (6) “Center tank” means any tank inboard of a longitudinal bulkhead.
- (7) “Slop tank” means a tank specifically designed for the collection of tank drainings, tank washings and other oily mixtures.
- (8) “Electronic record book” means a device or system, approved by the Administration, used to electronically record the required entries for discharges, transfers and other operations as required under this Part in lieu of a hard copy record book.
- (9) “Unmanned non-self-propelled (UNSP) barge” means a barge that:
 - (a) is not propelled by mechanical means;
 - (b) carries no oil;
 - (c) has no machinery fitted that may use oil or generate oil residue (sludge);
 - (d) has no oil fuel tanks, lubricating oil tanks, oily bilge water holding tanks and oil residue (sludge) tanks; and
 - (e) has neither persons nor living animals on board.

1.2 General Rules**1.2.1 Restriction on Oil Tanks (Regulation 16 of Annex I)**

1 For ships of 400 gross tonnage and above, no oil tanks are to be provided in a space afore the fore peak tank or the collision bulkhead.

2 For ships of 4,000 gross tonnage and above other than oil tankers and oil tankers of 150 gross tonnage and above, the fuel oil pipelines including fuel oil tanks are to be segregated from the ballast pipelines. However, ships requiring ballast water in empty fuel oil tanks for the proper maintenance of stability and safety may be exempted from this requirement.

3 Ships other than those stated in the preceding -1 and -2 are to satisfy the requirements in the preceding -1 and -2 as far as reasonable and practicable.

1.2.2 Oil Record Book (Regulations 17 and 36 of Annex I)*

Every oil tanker of 150 gross tonnage and above and every ship of 400 gross tonnage and above other than an oil tanker are to be provided with an Oil Record Book to record relevant issues including any of the following operations. The Oil Record Book, whether as a part of the ship's official logbook, as an electronic record book which is to be approved by the Administration taking into account the Guidelines developed by IMO, or otherwise, is to be in the form specified in Appendix III to Annex I.

- (1) Machinery space operations
 - (a) Ballasting or cleaning of oil fuel tanks
 - (b) Discharging of dirty ballast or cleaning water from oil fuel tanks
 - (c) Collection and disposal of oil residues (sludge)
 - (d) Discharge overboard or disposal otherwise of oily bilge water which has accumulated in machinery spaces
 - (e) Bunkering of fuel or bulk lubricating oil

- (2) Cargo/ballast operations for oil tankers
- (a) Loading of oil cargo
 - (b) Internal oil transfer of oil cargo during voyage
 - (c) Unloading oil cargo
 - (d) Ballasting of cargo tanks and dedicated clean ballast tanks
 - (e) Cleaning of cargo tanks including crude oil washing
 - (f) Discharge of ballast except from segregated ballast tanks
 - (g) Discharge of water from slop tanks
 - (h) Closing of all applicable valves or similar devices after slop tank discharge operations
 - (i) Closing of valve necessary for isolation of dedicated clean ballast tanks from cargo and stripping lines after slop tank discharge operations
 - (j) Disposal of oil residues (sludge)

1.2.3 Oil Fuel Tank Protection (Regulation 12A of Annex I)*

1 For ships with an aggregated oil fuel capacity of “C” as defined in 1.2.3-10(10), of $600m^3$ and above, the location of oil fuel tanks is to comply with the provisions of following -4 to -10. Notwithstanding the above, small oil fuel tanks as defined in -3(9) need not to comply with the provisions of -4 to -10, provided that the aggregate capacity of such excluded small tanks is not greater than $600m^3$.

2 The application of this paragraph in determining the location of tanks used to carry oil fuel does not govern over the provisions of 3.2.4 in Part 3.

3 For the purpose of this paragraph, the following definitions are to apply:

- (1) “Load line draught (d_s)” is the vertical distance, in m , from the moulded baseline at mid-length to the waterline corresponding to the summer freeboard draught to be assigned to the ship.
- (2) “Light ship draught” is the moulded draught amidships corresponding to the lightweight.
- (3) “Partial load line draught (d_p)” is the light ship draught plus 60% of the difference between the light ship draught and the load line draught d_s . The partial load line draught (d_p) shall be measured in m .
- (4) “Waterline (d_B)” is the vertical distance, in m , from the moulded baseline at mid-length to the waterline corresponding to 30% of the depth D_S .
- (5) “Breadth (B_S)” is the greatest moulded breadth of the ship, in m , at or below the deepest load line draught (d_s).
- (6) “Breadth (B_B)” is the greatest moulded breadth of the ship, in m , at or below the waterline (d_B).
- (7) “Depth (D_S)” is the moulded depth, in m , measured at mid-length to the upper deck at side. For the purpose of the application, “upper deck” means the highest deck to which the watertight transverse bulkheads except aft peak bulkheads extend.
- (8) “Oil fuel tank” means a tank in which oil fuel is carried, but excludes those tanks which would not contain oil fuel in normal operation, such as overflow tanks.
- (9) “Small oil fuel tank” is an oil fuel tank with a maximum individual capacity not greater than $30m^3$.
- (10) “C” is the ship’s total volume of oil fuel, including that of the small oil fuel tanks, in m^3 , at 98% tank filling.
- (11) “Oil fuel capacity” means the volume of a tank in m^3 , at 98% filling.

4 Individual oil fuel tanks are not to have a capacity of over $2,500m^3$.

5 For ships, other than self-elevating drilling units, oil fuel tanks are to be located above the moulded line of the bottom shell plating nowhere less than the distance h as specified below. In the turn of the bilge area and at locations without a clearly defined turn of the bilge, the oil fuel tank boundary line is to run parallel to the line of the midship flat bottom as shown in Fig. 3-1.

$$h = B/20 (m) \text{ or,}$$

$$h = 2.0 (m), \text{ whichever is the lesser.}$$

The minimum value of $h = 0.76 (m)$

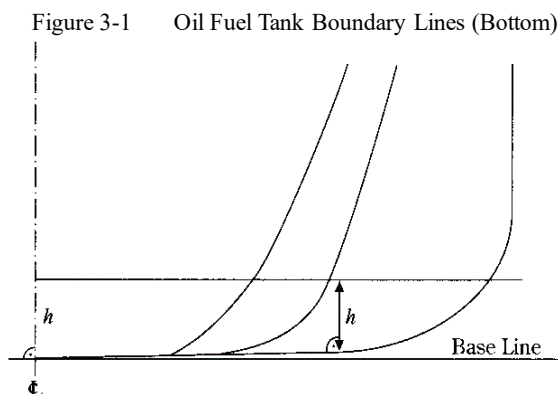

6 For ships having an aggregate oil fuel capacity of $600m^3$ or more but less than $5,000m^3$, oil fuel tanks are to be located inboard of the moulded line of the side shell plating, nowhere less than the distance w which, as shown in Fig. 3-2, is measured at any cross-section at right angles to the side shell, as specified below:

$$w = 0.4 + 2.4 C / 20,000 \text{ (m)}$$

The minimum value of $w = 1.0 \text{ (m)}$, however for individual tanks with an oil fuel capacity of less than $500m^3$ the minimum value is $0.76m$.

7 For ships having an aggregate oil fuel capacity of $5,000m^3$ and over, oil fuel tanks are to be located inboard of the moulded line of the side shell plating, nowhere less than the distance w which, as shown in Fig. 3-2, is measured at any cross-section at right angles to the side shell, as specified below:

$$w = 0.5 + C / 20,000 \text{ (m) or}$$

$$w = 2.0 \text{ (m), whichever is the lesser.}$$

The minimum value of $w = 1.0 \text{ (m)}$

Figure 3-2 Oil Fuel Tank Boundary Lines of Oil Fuel Tank (Bilge Area)

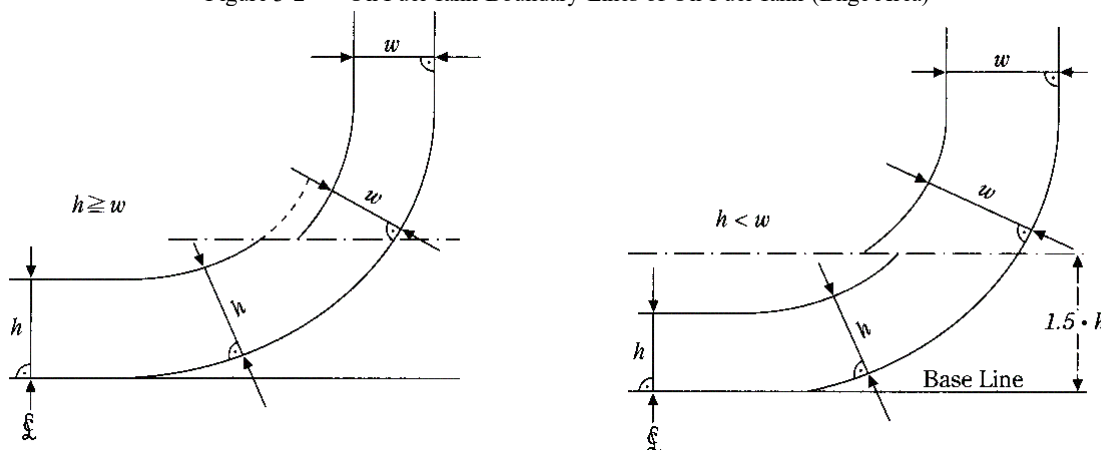

8 Lines of oil fuel piping located at a distance from the ship's bottom of less than h , as defined in -5, or from the ship's side less than w , as defined in -6 and -7 are to be fitted with valves or similar closing devices within or immediately adjacent to the oil fuel tank. These valves are to be capable of being brought into operation from a readily accessible enclosed space the location of which is accessible from the navigation bridge or propulsion machinery control position without traversing exposed freeboard or superstructure decks. The valves are to close in case of remote control system failure (fail in a closed position) and shall be kept closed at sea at any time when the tank contains oil fuel except that they may be opened during oil fuel transfer operations.

9 Suction wells in oil fuel tanks may protrude into the double bottom below the boundary line defined by the distance h provided that such wells are as small as practicable and the distance between the well bottom and the bottom shell plating is not less than $0.5h$.

10 Notwithstanding the provisions of -5 to -7, oil fuel tanks may be located so as to border on the ship's outer shell, provided that ships are to comply with the accidental oil fuel outflow performance standard specified below:

- (1) The level of protection against oil fuel pollution in the event of collision or grounding is to be assessed on the basis of the mean

oil outflow parameter (O_M) as follows:

$$O_M \leq 0.0157 - 1.14 \times 10^{-6} \cdot C \quad \text{for } 600 \leq C < 5,000 \text{ (m}^3\text{)}$$

$$O_M \leq 0.010 \quad \text{for } C \geq 5,000 \text{ (m}^3\text{)}$$

O_M : Mean oil outflow parameter

C : Total volume of oil fuel, in m^3 , at 98% tank filling

- (2) The following general assumptions are to apply when calculating the mean oil outflow parameter specified in (1) and (2) above.
- The ship is to be assumed loaded to the partial load line draught d_P without trim or heel.
 - All oil fuel tanks are to be assumed loaded to 98% of their volumetric capacity.
 - The nominal density of the oil fuel (ρ_n) is generally to be taken as $1,000 \text{ kg/m}^3$. If the density of the oil fuel is specially restricted to a lesser value, the lesser value may be applied.
 - For the purposes of these outflow calculations, the permeability of each oil fuel tank is to be taken as 0.99, unless proven otherwise.
- (3) The following assumptions are to be used when combining the oil outflow parameters.

- (a) The mean oil outflow is to be calculated independently for side damage and bottom damage and then combined into the non-dimensional oil outflow parameter O_M , as follows:

$$O_M = (0.4 \cdot O_{MS} + 0.6 \cdot O_{MB}) / C$$

O_{MS} : Mean outflow for side damage (m^3)

O_{MB} : Mean outflow for bottom damage (m^3)

- (b) For bottom damage, independent calculations for mean outflow are to be for $0m$ and minus $2.5m$ tide conditions, and then combined as follows:

$$O_{MB} = 0.7 \cdot O_{MB(0)} + 0.3 \cdot O_{MB(2.5)}$$

$O_{MB(0)}$: Mean outflow for $0m$ tide condition (m^3)

$O_{MB(2.5)}$: Mean outflow for minus $2.5m$ tide condition (m^3)

- (4) The mean outflow for side damage O_{MS} is to be calculated as follows:

$$O_{MS} = \sum_i^n P_{S(i)} \cdot O_{S(i)} \quad (m^3)$$

i : Represents each oil fuel tank under consideration

n : Total number of oil fuel tanks

$P_{S(i)}$: The probability of penetrating oil fuel tank i from side damage, calculated in accordance with (6)

$O_{S(i)}$: The outflow, in m^3 , from side damage to oil fuel tank i , which is assumed equal to the total volume in oil fuel tank i at 98% filling

- (5) The mean outflow for bottom damage is to be calculated for each tidal condition as follows:

$$(a) \quad O_{MB(0)} = \sum_i^n P_{B(i)} \cdot O_{B(i)} \cdot C_{DB(i)} \quad (m^3)$$

i : Represents each oil fuel tank under consideration

n : Total number of oil fuel tanks

$P_{B(i)}$: The probability of penetrating oil fuel tank i from bottom damage, calculated in accordance with (7)

$O_{B(i)}$: The outflow, in m^3 , from side damage to oil fuel tank i , calculated in accordance with (c) and (d)

$C_{DB(i)}$: Factor to account for oil capture as defined in (e)

$$(b) \quad O_{MB(2.5)} = \sum_i^n P_{B(i)} \cdot O_{B(i)} \cdot C_{DB(i)} \quad (m^3)$$

$i, n, P_{B(i)}$ and $C_{DB(i)}$: As defined in (a)

$O_{B(i)}$: The outflow from oil fuel tank i , in m^3 , after tidal change

- (c) The oil outflow $O_{B(i)}$ for each oil fuel tank is to be calculated based on pressure balance principles, in accordance with the following assumptions:

- The ship is to be assumed stranded with zero trim and heel, with the stranded draught prior to tidal change equal to the partial load line draught d_P .
- The oil fuel level after damage is to be calculated as follows:

$$h_F = \{(d_p + t_c - Z_l)(\rho_s)\}/\rho_n$$

h_F : The height of the oil fuel surface above Z_l (m)

t_c : The tidal change, in m. Reductions in tide are to be expressed as negative values.

Z_l : The height of the lowest point in the oil fuel tank above baseline (m)

ρ_s : Density of seawater, to be taken as 1,025 kg/m³

ρ_n : Nominal density of the oil fuel, as defined in (2)(c)

- (d) The oil outflow $O_{B(i)}$ for any tanks bounding the bottom shell is to be taken not less than the following formula, but no more than the tank capacity:

$$O_{B(i)} = H_W \cdot A$$

H_W is to be taken as follows:

- i) $H_W = 1.0$ (m), when $Y_B = 0$
- ii) $H_W = B_B/50$ but not greater than 0.4m, when Y_B is greater than $B_B/5$ or 11.5m, whichever is less. For Y_B values outboard $B_B/5$ or 11.5m, whichever is less, H_W is to be linearly interpolated. (See Fig. 3-3)
- iii) " H_W " is to be measured upwards from the midship flat bottom line. In the turn of the bilge area and at locations without a clearly defined turn of the bilge, H_W is to be measured from a line parallel to the midship flat bottom, as shown for distance " h " in Fig. 3-1.

Y_B : The minimum value of Y_B over the length of the oil fuel tank, where at any given location, Y_B is the transverse distance between the side shell at waterline dB and the tank at or below waterline d_B .

A : The maximum horizontal projected area of the oil fuel tank up to the level of H_W from the bottom of the tank.

- (e) In the case of bottom damage, a portion from the outflow from an oil fuel tank may be captured by non-oil compartments. This effect is approximated by application of the factor $C_{DB(i)}$ for each tank, which is to be taken as follows:

$C_{DB(i)} = 0.6$ for oil fuel tanks bounded from below by non-oil compartments;

$C_{DB(i)} = 1.0$ for otherwise.

- (6) The probability P_S of breaching a compartment from side damage is to be calculated as follows:

$$P_S = P_{SL} \cdot P_{SV} \cdot P_{ST}$$

$P_{SL} = 1 - P_{Sf} - P_{Sa}$: Probability the damage will extend into the longitudinal zone bounded by X_a and X_f

$P_{SV} = 1 - P_{Su} - P_{Sl}$: Probability the damage will extend into the vertical zone bounded by Z_l and Z_u

$P_{ST} = 1 - P_{Sy}$: Probability the damage will extend transversely beyond the boundary defined by y

P_{Sa}, P_{Sf}, P_{Sl} and P_{Su} : Probabilities defined as the follows, are to be determined by linear interpolation from the table of probabilities for side damage provided in Table 3-1.

P_{Sa} : The probability the damage will lie entirely aft of location X_a/L_f

P_{Sf} : The probability the damage will lie entirely forward of location X_f/L_f

P_{Sl} : The probability the damage will lie entirely below the tank

P_{Su} : The probability the damage will lie entirely above the tank

P_{Sy} : The probability the damage will lie entirely outboard of the tank. P_{Sy} is to be calculated as follows. However, P_{Sy} is not to be taken greater than 1.

$$P_{Sy} = (24.96 - 199.6y/B_S)(y/B_S) \quad \text{for } y/B_S \leq 0.05$$

$$P_{Sy} = 0.749 + \{5 - 44.4(y/B_S - 0.05)\}(y/B_S - 0.05) \quad \text{for } 0.05 < y/B_S < 0.1$$

$$P_{Sy} = 0.888 + 0.56(y/B_S - 0.1) \quad \text{for } y/B_S \geq 0.1$$

X_a : The longitudinal distance from the aft terminal of L_f to the aftmost point on the compartment being considered (m)

X_f : The longitudinal distance from the aft terminal of L_f to the foremost point on the compartment being considered (m)

Z_l : The vertical distance from the moulded baseline to the lowest point on the compartment being considered (m). Where Z_l is greater than D_S , Z_l is to be taken as D_S .

Z_u : The vertical distance from the moulded baseline to the highest point on the compartment being considered (m). Where Z_u is greater than D_S , Z_u is to be taken as D_S .

y : The minimum horizontal distance measured at right angles to the centreline between the compartment under consideration and the side shell (m). In way of the turn of the bilge, y need not to be considered below a distance h above baseline, where h is lesser of $B/10$, $3m$ or the top of the tank.

(7) The probability P_B of breaching a compartment from bottom damage is to be calculated as follows:

$$P_B = P_{BL} \cdot P_{BT} \cdot P_{BV}$$

$P_{BL} = 1 - P_{Bf} - P_{Ba}$: Probability the damage will extend into the longitudinal zone bounded by X_a and X_f

$P_{BT} = 1 - P_{Bp} - P_{Bs}$: Probability the damage will extend into the transverse zone bounded by Y_p and Y_s

$P_{BV} = 1 - P_{Bz}$: Probability the damage will extend vertically beyond the boundary defined by z

P_{Ba} , P_{Bf} , P_{Bp} and P_{Bs} : Probabilities defined as the follows, are to be determined by linear interpolation from the table of probabilities for side damage provided in **Table 3-2**.

P_{Ba} : The probability the damage will lie entirely aft of location X_a/L_f

P_{Bf} : The probability the damage will lie entirely forward of location X_f/L_f

P_{Bp} : The probability the damage will lie entirely to port of the tank

P_{Bs} : The probability the damage will lie entirely to starboard of the tank

P_{Bz} : The probability the damage will lie entirely below the tank. P_{Bz} is to be calculated as follows. However, P_{Bz} is not to be taken greater than 1.

$$P_{Bz} = (14.5 - 67z/D_S)(z/D_S) \quad \text{for } z/D_S \leq 0.1$$

$$P_{Bz} = 0.78 + 1.1(z/D_S - 0.1) \quad \text{for } z/D_S > 0.1$$

D_S : The moulded depth, in m , measured at mid-length to the upper deck at side

X_a and X_f : As defined in (6)

Y_p : The transverse distance from the port-most point on the compartment located at or below the waterline d_B , to a vertical plane located $B_B/2$ to starboard of the ship's centerline (m).

Y_s : The transverse distance from the starboard-most point on the compartment located at or below the waterline d_B , to a vertical plane located $B_B/2$ to starboard of the ship's centerline (m)

z : The minimum value of z over the length of the compartment, where, at any given longitudinal location, z is the vertical distance from the lower point of the bottom shell at that longitudinal location to the lower point of the compartment at that longitudinal location (m).

(8) For the purpose of maintenance and inspection, any oil fuel tanks that do not border the outer shell plating are to be located no closer to the bottom shell plating than the minimum value of h in -5 and no closer to the side shell plating than the applicable minimum value of w in -6 or -7.

Figure 3-3 Values relating to the Minimum Outflow

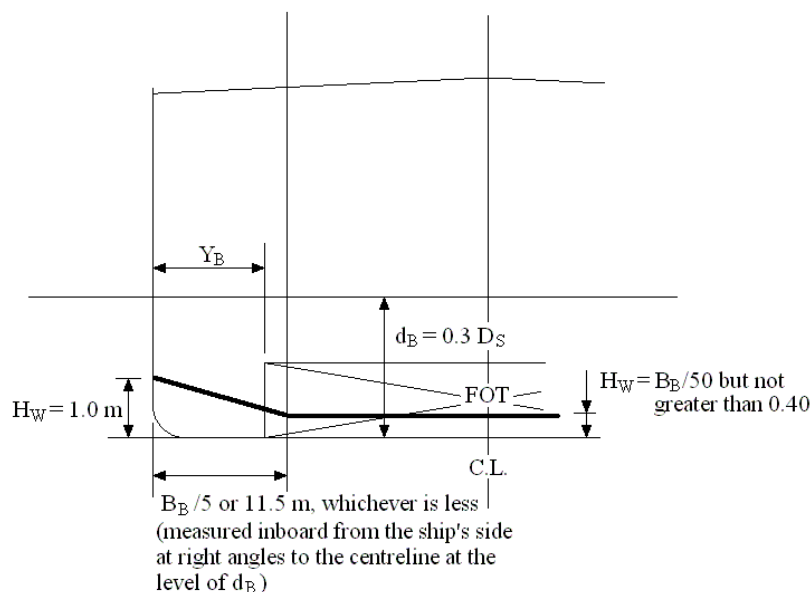

Table 3-1 Probabilities for Side Damage

X_a/L_f	P_{Sa}	X_f/L_f	P_{Sf}	Z_l/D_S	P_{Sl}	Z_u/D_S	P_{Su}
0.00	0.000	0.00	0.967	0.00	0.000	0.00	0.968
0.05	0.023	0.05	0.917	0.05	0.000	0.05	0.952
0.10	0.068	0.10	0.867	0.10	0.001	0.10	0.931
0.15	0.117	0.15	0.817	0.15	0.003	0.15	0.905
0.20	0.167	0.20	0.767	0.20	0.007	0.20	0.873
0.25	0.217	0.25	0.717	0.25	0.013	0.25	0.836
0.30	0.267	0.30	0.667	0.30	0.021	0.30	0.789
0.35	0.317	0.35	0.617	0.35	0.034	0.35	0.733
0.40	0.367	0.40	0.567	0.40	0.055	0.40	0.670
0.45	0.417	0.45	0.517	0.45	0.085	0.45	0.599
0.50	0.467	0.50	0.467	0.50	0.123	0.50	0.525
0.55	0.517	0.55	0.417	0.55	0.172	0.55	0.452
0.60	0.567	0.60	0.367	0.60	0.226	0.60	0.383
0.65	0.617	0.65	0.317	0.65	0.285	0.65	0.317
0.70	0.667	0.70	0.267	0.70	0.347	0.70	0.255
0.75	0.717	0.75	0.217	0.75	0.413	0.75	0.197
0.80	0.767	0.80	0.167	0.80	0.482	0.80	0.143
0.85	0.817	0.85	0.117	0.85	0.553	0.85	0.092
0.90	0.867	0.90	0.068	0.90	0.626	0.90	0.046
0.95	0.917	0.95	0.023	0.95	0.700	0.95	0.013
1.00	0.967	1.00	0.000	1.00	0.775	1.00	0.000

Table 3-2 Probabilities for Bottom Damage

X_a/L_f	P_{Ba}	X_f/L_f	P_{Bf}	Y_p/B_B	P_{Bp}	Y_s/B_B	P_{Bs}
0.00	0.000	0.00	0.969	0.00	0.844	0.00	0.000
0.05	0.002	0.05	0.953	0.05	0.794	0.05	0.009
0.10	0.008	0.10	0.936	0.10	0.744	0.10	0.032
0.15	0.017	0.15	0.916	0.15	0.694	0.15	0.063
0.20	0.029	0.20	0.894	0.20	0.644	0.20	0.097
0.25	0.042	0.25	0.870	0.25	0.594	0.25	0.133
0.30	0.058	0.30	0.842	0.30	0.544	0.30	0.171
0.35	0.076	0.35	0.810	0.35	0.494	0.35	0.211
0.40	0.096	0.40	0.775	0.40	0.444	0.40	0.253
0.45	0.119	0.45	0.734	0.45	0.394	0.45	0.297
0.50	0.143	0.50	0.687	0.50	0.344	0.50	0.344
0.55	0.171	0.55	0.630	0.55	0.297	0.55	0.394
0.60	0.203	0.60	0.563	0.60	0.253	0.60	0.444
0.65	0.242	0.65	0.489	0.65	0.211	0.65	0.494
0.70	0.289	0.70	0.413	0.70	0.171	0.70	0.544
0.75	0.344	0.75	0.333	0.75	0.133	0.75	0.594
0.80	0.409	0.80	0.252	0.80	0.097	0.80	0.644
0.85	0.482	0.85	0.170	0.85	0.063	0.85	0.694
0.90	0.565	0.90	0.089	0.90	0.032	0.90	0.744
0.95	0.658	0.95	0.026	0.95	0.009	0.95	0.794
1.00	0.761	1.00	0.000	1.00	0.000	1.00	0.844

1.2.4 STS Operations Plan (Regulation 41 of Annex I)*

1 For oil tankers of 150 gross tonnage and above engaged in the transfer of oil cargo between oil tankers at sea (STS operations), a STS operations Plan approved by the Society is to be provided on board. The plan is to be written in the working language of the master and officers of the ship. If the language used in the plan is not English, an English translation is to accompany it.

2 Transfer operations of oil cargo are to be recorded in the Oil Record Book or other Record Book which is considered appropriate by the Society. The record is to be provided on board for at least 3 years.

1.2.5 Special Requirements for the Use or Carriage of Oils in the Antarctic Area (Regulation 43 of Annex I)*

With the exception of vessels engaged in securing the safety of ships or in a search and rescue operation, the carriage in bulk as cargo, use as ballast, or carriage and use as fuel of the following:

- (1) crude oils having a density at 15°C higher than 900 kg/m^3 ;
- (2) oils, other than crude oils, having a density at 15°C higher than 900 kg/m^3 or a kinematic viscosity at 50°C higher than 180 mm^2/s ; or
- (3) bitumen, tar and their emulsions,
are to be prohibited in the Antarctic area, as defined in Annex I, Regulation 1.11.7. However, when prior operations have included the carriage or use of any of the oils listed above, the cleaning or flushing of tanks or pipelines is not required

1.2.6 Special Requirements for the Use and Carriage of Heavy Fuel Oils as Fuel in Arctic Waters (*Regulation 43A of Annex I*)*

1. With the exception of ships engaged in securing the safety of ships or in search and rescue operations, and ships dedicated to oil spill preparedness and response, the use and carriage of oils listed in **1.2.5(2)** as fuel by ships is prohibited in Arctic waters on or after 1 July 2024.
2. Notwithstanding the provisions in **-1** above, the use and carriage of oils listed in **1.2.5(2)** as fuel by ships is prohibited in Arctic waters on or after 1 July 2029 for ships subject to which **1.2.3** or **2.2.1, Part 9**.
3. When operations prior to entering Arctic waters have included the use and carriage of oils listed in **1.2.5(2)** as fuel, the cleaning or flushing of tanks or pipelines is not required.

Chapter 2 EQUIPMENT FOR THE PREVENTION OF POLLUTION BY OIL FROM MACHINERY SPACES

2.1 General

2.1.1 Application

The requirements in this chapter apply to the construction and equipment for the prevention of pollution by oil or oily mixtures produced from the machinery space of all ships.

2.2 Storage and Discharge of Oil Residues (Sludge) (Regulations 12 and 13 of Annex 1)

2.2.1 Capacity of Oil Residue (Sludge) Tanks*

Every ship of 400 *gross tonnage* and above is to be provided with a tank or tanks of adequate capacity to receive the oil residue (sludge). The capacity of such a tank or tanks is to be greater the minimum capacity specified in the following (1) or (2). However, the volume of tanks for ships whose building contract is placed before 1 July 2010 are to comply with provisions specified elsewhere.

- (1) The minimum capacity V_1 of the tank in ships not carrying ballast water in fuel oil tanks:

$$V_1 = K_1 CD \text{ (m}^3\text{)}$$

where

$K_1 = 0.015$: heavy fuel oil which is purified before being used by the main engine

$K_1 = 0.005$: marine diesel oil or heavy fuel oil but not requiring purification

C : fuel oil consumption (*t/day*)

D : maximum number of days between ports where oil sludge can be discharged ashore
(when no detailed data is available, this is to be made greater than 30 *days*)

- (2) Minimum tank capacity (V_2) in ships where ballast water is carried in fuel oil tanks:

$$V_2 = V_1 + K_2 B \text{ (m}^3\text{)}$$

where

V_1 : tank capacity determined either by (1) above

$K_2 = 0.01$: where ballast water is carried in heavy fuel oil tanks

$K_2 = 0.005$: where ballast water is carried in marine diesel oil tanks

B = capacity (*tons*) of fuel oil tanks connected to ballast pipelines

2.2.2 Construction of Oil Residue (Sludge) Tanks and Piping Arrangements*

1 The construction and piping arrangements of sludge tanks required under the requirements of the preceding 2.2.1 are to meet the following requirements (1) to (6):

- (1) Manholes or access holes in a sufficient size are to be provided at such locations that each part of the tank can be cleaned without difficulties.
- (2) Appropriate means to facilitate drawing and discharge of oil residues (sludge) are to be provided.
- (3) Except for the standard discharge connection specified in 2.2.3, no direct overboard discharge connections are to be provided.
- (4) The piping may be so arranged that oil residue (sludge) may be disposed of directly from the oil residue (sludge) tank(s) to reception facilities through the standard discharge connection specified in 2.2.3, or to any other approved means of disposal of oil residue (sludge), such as an incinerator, auxiliary boiler suitable for burning oil residues (sludge) or other acceptable means.
- (5) The tank(s) are to be provided with a designated pump that is capable of taking suction from the oil residue (sludge) tank(s) for disposal of oil residue (sludge) by means as specified in the preceding (4).
- (6) The tank(s) are to have no discharge connections to the bilge system, oily bilge water holding tank(s), tank top or oily water separators, except as specified in the following (a) and (b). However, ships which were at the beginning stage of construction before 1 January 2017 are to be arranged to comply with this requirement not later than the first special survey carried out on

or after that date.

- (a) The tank(s) may be fitted with drains, with manually operated self-closing valves and arrangements for subsequent visual monitoring of the settled water, that lead to an oily bilge water holding tank or bilge well, or an alternative arrangement, provided such arrangement does not connect directly to the bilge discharge piping system; and
- (b) The sludge tank discharge piping and bilge-water piping may be connected to a common piping leading to the standard discharge connection specified in 2.2.3; the connection of both systems to the possible common piping leading to the standard discharge connection specified in 2.2.3 is not to allow for the transfer of sludge to the bilge system.

2 For ships which were at beginning stage of construction on or after 31 December 1990, in addition to the preceding -1, the pumps specified in the preceding -1(5) are to meet the following (1) to (3):

- (1) The pumps are not to serve in common with the oily bilge pump.
- (2) The pumps are to be of a type suitable for discharging oil residues (sludge) ashore.
- (3) The pumping rate is to be the following Q or greater. However, ships whose building contract is placed before 1 July 2010 are to comply with provisions specified elsewhere. Notwithstanding this requirement, in ships not engaged in international voyages, the pumping rate may be $0.5 (m^3/h)$

$$Q = V/t (m^3/h)$$

where

V : V_1 or V_2 specified in 2.2.1-1

t : 8 hours

2.2.3 Standard Discharge Connection

To enable pipes of reception facilities to be connected with the ship's discharge pipeline of the sludge tank provided under the requirements of the preceding 2.2.2, a standard discharge connection in accordance with Table 3-3 is to be provided.

2.3 Oily-water Separating Equipment, Oil Filtering System, Oil Discharge Monitoring and Control System for Oily Bilge Water, and Oily Bilge Water Holding Tanks (Regulation 14 of Annex I)

2.3.1 Oily-water Separating Equipment*

Oily-water separating equipment is to be of a design approved by the Society and to be such as will ensure that any oily mixture discharged into the sea after passing through the oily-water separating equipment is to have an oil content of not more than 100ppm.

2.3.2 Oil Filtering System*

1 An oil filtering system is to meet either of the following requirements (1), (2) or (3) according to the type and size of ship, and trade area:

- (1) It is to be of a design approved by the Society and to be such as will ensure that any oily mixture discharged into the sea after passing through the filtering system is to have an oil content of not more than 15ppm.
- (2) It is to be satisfied with the requirements in (1) and to be fitted with an approved type of audible and visible alarm devices which automatically operates when the oil content in the effluent exceeds 15ppm, and which also automatically operates when defects or failures of the measuring function occur.
- (3) It is to be satisfied with the requirements in (2) and to be provided with an automatic discharge stopping device such as will ensure automatic stopping of the system when the oil content of the effluent exceeds 15ppm.

2 The piping arrangements for the oil filtering system are to conform with the provisions specified elsewhere.

2.3.3 Oil Discharge Monitoring and Control System for Oily Bilge Water*

An oil discharge monitoring and control system is to be of a design approved by the Society and to have the following function:

- (1) It is to be fitted with a device capable of continuously recording the oil content in ppm.
- (2) Recording function referred in (1) above is to include time and date.
- (3) It is to come into function simultaneously with the start of discharge of the effluent into the sea.
- (4) When the oil content in the effluent exceeds 100ppm, or when defects or failures of the measuring units occur, audible and visible alarms are to be issued with automatic stopping of the discharge of oily mixtures.

Table 3-3 Standard Dimensions of Discharge Connection Flange

Item	Requirements
Outside diameter	215 mm
Inside diameter	A diameter reasonably corresponding to the outside diameter
Pitchcircle diameter	183 mm
flange groove	Six 22 mm-dia holes are to be drilled on the above pitchcircle dia at equal angular intervals, and grooves of 22 mm wide from these holes reaching the outer periphery of the flange are to be machined.
Thickness of flange	20 mm
Number and diameter of bolts and nuts with a proper length	6 sets of 20 mm dia.
flanges are to be of steel or equivalent material with plain surfaces. This flange is to withstand a service pressure of 0.6 MPa when an oil-resistant gasket is inserted.	

2.3.4 Oily Bilge Water Holding Tanks*

Oily Bilge water holding tanks fitted onto ships complying with the requirements given in 2.4.2-2 are to satisfy the following requirements:

- (1) Capacity of the oily bilge water holding tank (C (m^3)) is to be the value obtained by the following formula or more. However, ships whose building contract is placed before 1 July 2010, ships of less than 400 gross tonnage and oil tankers of less than 150 gross tonnage may be exempted from these requirements. In addition, for ships adopting a system where special consideration is given regarding the handling of oily bilge water, the capacity of oily bilge water holding tanks may be reduced.

- (a) Ships whose maximum continuous output of main engine is less than 1,000kW

$$C = 4.0 (m^3)$$

- (b) Ships whose maximum continuous output of main engine is 1,000kW or more but less than 20,000kW

$$C = P / 250 (m^3)$$

where

P : maximum continuous output of main engine (kW)

- (c) Ships whose maximum continuous output of main engine is 20,000kW or more

$$C = 40 + P / 500 (m^3)$$

where

P : maximum continuous output of main engine (kW)

- (2) Oily bilge water holding tanks are to be provided with a device capable of measuring the quantity of oily bilge water.
- (3) It is to be ensured that no leakage of oily bilge water occurs even when the ship pitches through 10 degrees and rolls by 22.5

degrees either side.

- (4) The arrangement is to be such that it is capable of transferring bilge to both the oily bilge water holding tank and shore reception facilities. In this case, it is to be provided with a standard discharge connection specified in [Table 3-1](#) in [2.2.3](#).

2.4 Requirements for Installation (Regulation 14 of Annex I)

2.4.1 General

1 For all oil tankers and ships of 100 *gross tonnage* and above other than oil tankers, oil filtering systems are to be provided for discharging oily bilge water or other oil in accordance with [Table 3-4](#).

2 For ships other than oil tankers, of less than 100 *gross tonnage*, where any oily bilge water is to be discharged into the sea, oil filtering systems specified in [2.3.2-1\(1\)](#) are to be provided.

Table 3-4 Installation Requirements for Oil Filtering System

Trade area and type of ship		Gross tonnage			
		Less than 100	100 and above but less than 400	400 and above but less than 10,000	10,000 and above
Ships exclusively engaged in voyages in special area or arctic waters	Oil tankers				
	Ships other than oil tankers	-**	(I)*	(II)*	
Ships other than above	Oil tankers				
	Ships other than oil tankers	-**	(I)	(II)	

Remarks:

Symbols in the table signify the following equipment;

(I) Oil filtering system specified in [2.3.2-1\(1\)](#)

(II) Oil filtering system specified in [2.3.2-1\(3\)](#)

* : For ships exclusively engaged in voyages in antarctic area or arctic waters, the system may be replaced by oily bilge water storage arrangements.

** : Ships are, as far as practicable, to be equipped to retain on board oil or oily mixtures.

2.4.2 Modifications

1 Except ships exclusively engaged in voyages in special area, for ships of 4,000 *gross tonnage* and above other than oil tankers and oil tankers of 150 *gross tonnage* and above, the equipment required according in the column for ships of 10,000 *gross tonnage* and above are to be provided for discharging dirty ballast water carried in the fuel oil tanks in accordance with [1.2.1-2](#) into the sea.

2 Notwithstanding the requirements in the preceding [2.4.1](#), for ships listed below where all of the oily bilge water is intended to be discharged exclusively to reception facilities, oil filtering system may be substituted with oily bilge water holding tanks.

- (1) Ships exclusively engaged in voyages in special areas or arctic waters (defined in [1.2.1\(27\)](#), [Part I of the Rules for the Survey and Construction of Steel Ships](#), hereinafter the same in this Part).
- (2) Ships of less than 400 *gross tonnage* and exclusively engaged in voyage within 12 *nautical miles* from the territorial base line of any one state.
- (3) Ships subject to the [Rules for High Speed Craft](#) engaged on a scheduled service with a turn-around time not exceeding 24 *hours* and covering also non-passenger/cargo-carrying relocation voyages for these ships.
- (4) Ships, such as hotel ships, storage vessels, etc., which are stationary except for non-cargo-carrying relocation voyages.

Chapter 3 CONSTRUCTION AND EQUIPMENT FOR THE PREVENTION OF POLLUTION BY OIL CARRIED IN BULK

3.1 General

3.1.1 Application

1 The requirements in this chapter apply to construction and equipment for the prevention of pollution by oil carried in bulk in oil tankers.

2 The requirements of 3.2.4 are to apply to oil tankers of 600 tonnes deadweight and above:

- (1) for which the building contract is placed on or after 6 July 1993, or
- (2) in the absence of a building contract, which are at the beginning stage of construction on or after 6 January 1994, or
- (3) the delivery of which is on or after 6 July 1996, or
- (4) which have undergone a major conversion:
 - (a) for which the contract is placed after 6 July 1993; or
 - (b) in the absence of a contract, the construction work of which is begun after 6 January 1994; or
 - (c) which is completed after 6 July 1996.

3 The requirements of 3.2.2-6 and -7 are to apply to oil tankers of 5,000 tonnes deadweight and above:

- (1) for which the building contract is placed on or after 1 February 1999, or
- (2) in the absence of a building contract, which are at the beginning stage of construction on or after 1 August 1999, or
- (3) the delivery of which is on or after 1 February 2002, or
- (4) which have undergone a major conversion:
 - (a) for which the contract is placed after 1 February 1999,
 - (b) in the absence of a contract, the construction work of which is begun after 1 August 1999, or
 - (c) which is completed after 1 February 2002.

4 The requirements of 3.2.5 are to apply to oil tankers of 5,000 tonnes deadweight and above, which are at beginning stage of construction on or after 1 January 2007.

5 The requirements of 3.2.1-1 and 3.3.2-5 are to apply to oil tankers:

- (1) for which the building contract is placed on or after 1 January 2007, or
- (2) in the absence of a building contract, which are at beginning stage of construction on or after 1 July 2007, or
- (3) the delivery of which is on or after 1 January 2010, or
- (4) which have undergone a major conversion:
 - (a) for which the contract is placed on or after 1 January 2007,
 - (b) in the absence of a contract, the construction work of which is begun on or after 1 July 2007, or
 - (c) which is completed on or after 1 January 2010.

3.2 Hull Construction

3.2.1 Arrangements of Bulkheads in Spaces Carrying Cargo Oil (Regulations 23, 24, 25 and 26 of Annex I)*

1 To provide adequate protection against oil pollution in the event of collision or stranding the following is to be complied with the followings.

(1) For oil tankers of 5,000 tonnes deadweight (*DWT*) and above, the mean oil outflow parameter (O_M) is to be as follows:

$$O_M \leq 0.015 \quad \text{for } C \leq 200,000 \text{ (m}^3\text{)}$$

$$O_M \leq 0.012 + \frac{0.003}{200,000} (400,000 - C) \quad \text{for } 200,000 < C < 400,000 \text{ (m}^3\text{)}$$

$$O_M \leq 0.012 \quad \text{for } C \geq 400,000 \text{ (m}^3\text{)}$$

O_M : Mean oil outflow parameter

C : Total volume of cargo oil, in m^3 , at 98% tank filling

- (2) Notwithstanding the above (1), for combination carriers between 5,000 tonnes deadweight (DWT) and 200,000 m^3 capacity, the mean oil outflow parameter may be applied, provided calculations are submitted to the satisfaction of the Society, demonstrating that after accounting for its increased structural strength, the combination carrier has at least equivalent oil outflow performance to a standard double hull tanker of the same size having a $O_M \leq 0.015$.

$$O_M \leq 0.021 \quad \text{for } C \leq 100,000 \text{ (} m^3 \text{)}$$

$$O_M \leq 0.015 + \frac{0.006}{100,000} (200,000 - C) \quad \text{for } 100,000 < C < 200,000 \text{ (} m^3 \text{)}$$

- (3) For oil tankers of less than 5,000 tonnes deadweight (DWT), the length of each cargo tank is not to exceed 10 m or one of the following values, whichever is the greater:

- (a) where no longitudinal bulkhead is provided inside the cargo tanks:

$$\left(0.5 \frac{b_i}{B} + 0.1\right) L_f, \text{ but not to exceed } 0.2L_f$$

- (b) where a centreline longitudinal bulkhead is provided inside the cargo tanks:

$$\left(0.25 \frac{b_i}{B} + 0.15\right) L_f$$

- (c) where two or more longitudinal bulkheads are provided inside the cargo tanks:

i) for wing cargo tanks: $0.2L_f$

- ii) for centre cargo tanks:

1) if $\frac{b_i}{B} \geq 0.2$: $0.2L_f$

2) if $\frac{b_i}{B} < 0.2$:

- where no centreline longitudinal bulkhead is provided:

$$\left(0.5 \frac{b_i}{B} + 0.1\right) L_f$$

- where a centreline longitudinal bulkhead is provided:

$$\left(0.25 \frac{b_i}{B} + 0.15\right) L_f$$

“ b_i ” is the minimum distance, in m , from the ship’s side to the outer longitudinal bulkhead of the tank in question measured inboard at right angles to the centreline at the level corresponding to the assigned summer freeboard.

- (4) The following general assumptions are to apply when calculating the mean oil outflow parameter specified in (1) and (2) above.

- (a) The cargo block length extends between the forward and aft extremities of all tanks arranged for the carriage of cargo oil, including slop tanks.

- (b) Where this regulation refers to cargo tanks, it is to be understood to include all cargo tanks, slop tanks and fuel tanks located within the cargo block length.

- (c) The ship is to be assumed loaded to the load line draught d_S without trim or heel. “ d_S ” is the vertical distance, in m , from the moulded baseline at mid-length to the waterline corresponding to the summer freeboard to be assigned to the ship. Calculations pertaining to this regulation are to be based on draught d_S , notwithstanding assigned draughts that may exceed d_S , such as the tropical loadline.

- (d) All cargo oil tanks are to be assumed loaded to 98% of their volumetric capacity. The nominal density of the cargo oil (ρ_n) is to be calculated as follows:

$$\rho_n = 1000 \frac{DWT}{C} \text{ (} kg/m^3 \text{)}$$

DWT : Deadweight (tonnes)

- (e) For the purposes of these outflow calculations, the permeability of each space within the cargo block, including cargo tanks, ballast tanks and other non-oil spaces is to be taken as 0.99, unless proven otherwise.

- (f) Suction wells may be neglected in the determination of tank location provided that such wells are as small as practicable and the distance between the well bottom and bottom shell plating is not less than $0.5h$, where h is the height as defined in 3.2.4(1)(a)iii).

(5) The following assumptions are to be used when combining the oil outflow parameters.

(a) The mean oil outflow is to be calculated independently for side damage and bottom damage and then combined into the non-dimensional oil outflow parameter O_M , as follows:

$$O_M = (0.4 \cdot O_{MS} + 0.6 \cdot O_{MB})/C$$

O_{MS} : Mean outflow for side damage (m^3)

O_{MB} : Mean outflow for bottom damage (m^3)

(b) For bottom damage, independent calculations for mean outflow are to be for 0 m and minus 2.5 m tide conditions, and then combined as follows:

$$O_{MB} = 0.7 \cdot O_{MB(0)} + 0.3 \cdot O_{MB(2.5)}$$

$O_{MB(0)}$: Mean outflow for 0 m tide condition (m^3)

$O_{MB(2.5)}$: Mean outflow for minus 2.5 m tide condition (m^3)

(6) The mean outflow for side damage O_{MS} is to be calculated as follows:

$$O_{MS} = C_3 \sum_i^n P_{S(i)} \cdot O_{S(i)} \quad (m^3)$$

i : Represents each cargo tank under consideration

n : Total number of cargo tanks

$P_{S(i)}$: The probability of penetrating cargo tank i from side damage, calculated in accordance with (8)

$O_{S(i)}$: The outflow, in m^3 , from side damage to cargo tank i , which is assumed equal to the total volume in cargo tank i at 98% filling, unless it is proven by methods deemed appropriate by the Society that any significant cargo volume will be retained

C_3 : C_3 equals 0.77 for ships having two longitudinal bulkheads inside the cargo tanks, provided these bulkheads are continuous over the cargo block and $P_{S(i)}$ is developed in accordance with this regulation. C_3 equals 1.0 for all other ships or when $P_{S(i)}$ is developed in accordance with (10).

(7) The mean outflow for bottom damage is to be calculated for each tidal condition as follows:

$$(a) \quad O_{MB(0)} = \sum_i^n P_{B(i)} \cdot O_{B(i)} \cdot C_{DB(i)} \quad (m^3)$$

i : Represents each cargo tank under consideration

n : Total number of cargo tanks

$P_{B(i)}$: The probability of penetrating cargo tank i from bottom damage, calculated in accordance with (9)

$O_{B(i)}$: The outflow, in m^3 , from side damage to cargo tank i , calculated in accordance with (c) and (d)

$C_{DB(i)}$: Factor to account for oil capture as defined in (e)

$$(b) \quad O_{MB(2.5)} = \sum_i^n P_{B(i)} \cdot O_{B(i)} \cdot C_{DB(i)} \quad (m^3)$$

i , n , $P_{B(i)}$ and $C_{DB(i)}$: As defined in (a)

$O_{B(i)}$: The outflow from cargo tank i , in m^3 , after tidal change

(c) The oil outflow $O_{B(i)}$ for each cargo oil tank is to be calculated based on pressure balance principles, in accordance with the following assumptions:

i) The ship is to be assumed stranded with zero trim and heel, with the stranded draught prior to tidal change equal to the load line draught d_S .

ii) The cargo level after damage is to be calculated as follows:

$$h_C = \{(d_S + t_C - Z_i)\rho_S - (1000p)/g\}/\rho_n$$

h_C : The height of the cargo oil above Z_i (m)

t_C : The tidal change, in m . Reductions in tide are to be expressed as negative values.

Z_i : The height of the lowest point in the cargo tank above baseline (m)

ρ_S : Density of seawater, to be taken as 1,025 kg/m^3

p : If an inert gas system is fitted, the normal overpressure, in kPa , to be taken as not less than 5 kPa ; if an inert gas system is not fitted, the overpressure may be taken as 0.

g : The acceleration of gravity, to be taken as 9.81 m/s^2

ρ_n : Nominal density of cargo oil, calculated in accordance with (4)(d)

- (d) For cargo tanks bounded by the bottom shell, unless proven otherwise, oil outflow $O_{B(i)}$ is to be taken not less than 1% of the total volume of cargo oil loaded in cargo tank i , to account for initial exchange losses and dynamic effects due to current and waves.
- (e) In the case of bottom damage, a portion from the outflow from a cargo tank may be captured by non-oil compartments. This effect is approximated by application of the factor $C_{DB(i)}$ for each tank, which is to be taken as follows:

$C_{DB(i)} = 0.6$ for cargo tanks bounded from below by non-oil compartments;

$C_{DB(i)} = 1.0$ for cargo tanks bounded by the bottom shell.

- (8) The probability P_S of breaching a compartment from side damage is to be calculated as follows:

$$P_S = P_{SL} \cdot P_{SV} \cdot P_{ST}$$

$P_{SL} = 1 - P_{Sf} - P_{Sa}$: Probability the damage will extend into the longitudinal zone bounded by X_a and X_f

$P_{SV} = 1 - P_{Su} - P_{Sl}$: Probability the damage will extend into the vertical zone bounded by Z_l and Z_u

$P_{ST} = 1 - P_{Sy}$: Probability the damage will extend transversely beyond the boundary defined by y

P_{Sa} , P_{Sf} , P_{Sl} and P_{Su} : Probabilities defined as the follows, are to be determined by linear interpolation from the table of probabilities for side damage provided in [Table 3-5](#).

P_{Sa} : The probability the damage will lie entirely aft of location X_a/L_f

P_{Sf} : The probability the damage will lie entirely forward of location X_f/L_f

P_{Sl} : The probability the damage will lie entirely below the tank

P_{Su} : The probability the damage will lie entirely above the tank

P_{Sy} : The probability the damage will lie entirely outboard of the tank. P_{Sy} is to be calculated as follows. However, P_{Sy} is not to be taken greater than 1.

$$P_{Sy} = (24.96 - 199.6y/B_S)(y/B_S) \quad \text{for } y/B_S \leq 0.05$$

$$P_{Sy} = 0.749 + \{5 - 44.4(y/B_S - 0.05)\}(y/B_S - 0.05) \quad \text{for } 0.05 < y/B_S < 0.1$$

$$P_{Sy} = 0.888 + 0.56(y/B_S - 0.1) \quad \text{for } y/B_S \geq 0.1$$

B_S : The greatest moulded breadth of the ship, in m , at or below the deepest load line d_S .

X_a : The longitudinal distance from the aft terminal of L_f to the aftmost point on the compartment being considered (m)

X_f : The longitudinal distance from the aft terminal of L_f to the foremost point on the compartment being considered (m)

Z_l : The vertical distance from the moulded baseline to the lowest point on the compartment being considered (m)

Z_u : The vertical distance from the moulded baseline to the highest point on the compartment being considered (m).
 Z_u is not to be taken greater than D_S .

y : The minimum horizontal distance measured at right angles to the centreline between the compartment under consideration and the side shell (m)

- (9) The probability P_B of breaching a compartment from bottom damage is to be calculated as follows:

$$P_B = P_{BL} \cdot P_{BT} \cdot P_{BV}$$

$P_{BL} = 1 - P_{Bf} - P_{Ba}$: Probability the damage will extend into the longitudinal zone bounded by X_a and X_f

$P_{BT} = 1 - P_{Bp} - P_{Bs}$: Probability the damage will extend into the transverse zone bounded by Y_p and Y_s

$P_{BV} = 1 - P_{Bz}$: Probability the damage will extend vertically beyond the boundary defined by z

P_{Ba} , P_{Bf} , P_{Bp} and P_{Bs} : Probabilities defined as the follows, are to be determined by linear interpolation from the table of probabilities for side damage provided in [Table 3-6](#).

P_{Ba} : The probability the damage will lie entirely aft of location X_a/L_f

P_{Bf} : The probability the damage will lie entirely forward of location X_f/L_f

P_{Bp} : The probability the damage will lie entirely to port of the tank

P_{Bs} : The probability the damage will lie entirely to starboard of the tank

P_{Bz} : The probability the damage will lie entirely below the tank. P_{Bz} is to be calculated as follows. However, P_{Bz} is not to be taken greater than 1.

$$P_{Bz} = (14.5 - 67z/D_S)(z/D_S) \quad \text{for } z/D_S \leq 0.1$$

$$P_{Bz} = 0.78 + 1.1(z/D_S - 0.1) \quad \text{for } z/D_S > 0.1$$

D_S : The moulded depth, in m , measured at mid-length to the upper deck at side

X_a and X_f : As defined in (8)

Y_p : The transverse distance from the port-most point on the compartment located at or below the waterline d_B , to a vertical plane located $B_B/2$ to starboard of the ship's centerline (m). " B_B " is the greatest moulded breadth of the ship, in m , at or below the waterline d_B . " d_B " is the vertical distance, in m , from the moulded baseline at mid-length to the waterline corresponding to 30% of the depth D_S .

Y_s : The transverse distance from the starboard-most point on the compartment located at or below the waterline d_B , to a vertical plane located $B_B/2$ to starboard of the ship's centerline (m)

z : The minimum value of z over the length of the compartment, where, at any given longitudinal location, z is the vertical distance from the lower point of the bottom shell at that longitudinal location to the lower point of the compartment at that longitudinal location (m).

(10) The calculation specified in the provisions of (4) to (9) above uses a simplified probabilistic approach where a summation is carried out over the contributions to the mean outflow from each cargo tank. For certain designs such as those characterized by the occurrence of steps/recesses in bulkheads/decks and for sloping bulkheads and/or a pronounced hull curvature, where deemed appropriate by the Society, more rigorous calculations may be appropriate.

(11) The following provisions regarding piping arrangements are to apply.

- (a) Lines of piping that run through cargo tanks in a position less than $0.30B_S$ from the ship's side or less than $0.30D_S$ from the ship's bottom are to be fitted with valves or similar closing devices at the point at which they open into any cargo tank. These valves are to be kept closed at sea at any time when the tanks contain cargo oil, except that they may be opened only for cargo transfer needed for essential cargo operations.
- (b) Credit for reducing oil outflow through the use of an emergency rapid cargo transfer system or other system arranged to mitigate oil outflow in the event of an accident may be taken into account where deemed appropriate by the Society.

Table 3-5 Probabilities for Side Damage

X_a/L_f	P_{Sa}	X_f/L_f	P_{Sf}	Z_l/D_S	P_{Sl}	Z_u/D_S	P_{Su}
0.00	0.000	0.00	0.967	0.00	0.000	0.00	0.968
0.05	0.023	0.05	0.917	0.05	0.000	0.05	0.952
0.10	0.068	0.10	0.867	0.10	0.001	0.10	0.931
0.15	0.117	0.15	0.817	0.15	0.003	0.15	0.905
0.20	0.167	0.20	0.767	0.20	0.007	0.20	0.873
0.25	0.217	0.25	0.717	0.25	0.013	0.25	0.836
0.30	0.267	0.30	0.667	0.30	0.021	0.30	0.789
0.35	0.317	0.35	0.617	0.35	0.034	0.35	0.733
0.40	0.367	0.40	0.567	0.40	0.055	0.40	0.670
0.45	0.417	0.45	0.517	0.45	0.085	0.45	0.599
0.50	0.467	0.50	0.467	0.50	0.123	0.50	0.525
0.55	0.517	0.55	0.417	0.55	0.172	0.55	0.452
0.60	0.567	0.60	0.367	0.60	0.226	0.60	0.383
0.65	0.617	0.65	0.317	0.65	0.285	0.65	0.317
0.70	0.667	0.70	0.267	0.70	0.347	0.70	0.255
0.75	0.717	0.75	0.217	0.75	0.413	0.75	0.197
0.80	0.767	0.80	0.167	0.80	0.482	0.80	0.143
0.85	0.817	0.85	0.117	0.85	0.553	0.85	0.092
0.90	0.867	0.90	0.068	0.90	0.626	0.90	0.046
0.95	0.917	0.95	0.023	0.95	0.700	0.95	0.013
1.00	0.967	1.00	0.000	1.00	0.775	1.00	0.000

Table 3-6 Probabilities for Bottom Damage

X_a/L_f	P_{Ba}	X_f/L_f	P_{Bf}	Y_p/B_B	P_{Bp}	Y_s/B_B	P_{Bs}
0.00	0.000	0.00	0.969	0.00	0.844	0.00	0.000
0.05	0.002	0.05	0.953	0.05	0.794	0.05	0.009
0.10	0.008	0.10	0.936	0.10	0.744	0.10	0.032
0.15	0.017	0.15	0.916	0.15	0.694	0.15	0.063
0.20	0.029	0.20	0.894	0.20	0.644	0.20	0.097
0.25	0.042	0.25	0.870	0.25	0.594	0.25	0.133
0.30	0.058	0.30	0.842	0.30	0.544	0.30	0.171
0.35	0.076	0.35	0.810	0.35	0.494	0.35	0.211
0.40	0.096	0.40	0.775	0.40	0.444	0.40	0.253
0.45	0.119	0.45	0.734	0.45	0.394	0.45	0.297
0.50	0.143	0.50	0.687	0.50	0.344	0.50	0.344
0.55	0.171	0.55	0.630	0.55	0.297	0.55	0.394
0.60	0.203	0.60	0.563	0.60	0.253	0.60	0.444
0.65	0.242	0.65	0.489	0.65	0.211	0.65	0.494
0.70	0.289	0.70	0.413	0.70	0.171	0.70	0.544
0.75	0.344	0.75	0.333	0.75	0.133	0.75	0.594
0.80	0.409	0.80	0.252	0.80	0.097	0.80	0.644
0.85	0.482	0.85	0.170	0.85	0.063	0.85	0.694
0.90	0.565	0.90	0.089	0.90	0.032	0.90	0.744
0.95	0.658	0.95	0.026	0.95	0.009	0.95	0.794
1.00	0.761	1.00	0.000	1.00	0.000	1.00	0.844

2 For spaces carrying oil cargoes of oil tankers not subject to the requirements of -1 above, oil-tight bulkheads are to be arranged so that hypothetical oil outflow and the restricted size of individual cargo oil tanks might not be exceeded due to damage defined as below.

- (1) For the purpose of calculating hypothetical oil outflow from oil tankers, three dimensions of damage of a parallel piped on the side and bottom of the ship are assumed in accordance with Table 3-7 and Table 3-8.
- (2) The hypothetical outflow of oil in the case of side damage (O_C) and bottom damage (O_S) are to be calculated by the following formulae with respect to compartments breached by damage to all conceivable locations along the length of the ship up to the extent as defined in (1).

(a)

i) for side damage :

$$O_C = \sum W_i + \sum K_i C_i \quad (I)$$

ii) for bottom damage :

$$O_S = 1/3 \left(\sum Z_i W_i + \sum Z_i C_i \right) \quad (II)$$

In the case where bottom damage simultaneously involves four centre tanks, the value of O_S may be calculated according to the formula.

$$O_S = 1/4 \left(\sum Z_i W_i + \sum Z_i C_i \right) \quad (III)$$

where

W_i : volume of a wing tank in m^3 assumed to be breached by the damage as specified in (1); W_i for a segregated ballast tank may be taken equal to zero,

C_i : volume of a centre tank in m^3 assumed to be breached by the damage as specified in (1); C_i for a segregated ballast tank may be taken equal to zero,

$$K_i = 1 - b_i/t_c$$

where b_i is equal to or greater than t_c , K_i is to be taken equal to zero.

$$Z_i = 1 - h_i/v_s$$

where h_i is equal to or greater than v_s , Z_i may be taken equal to zero.

b_i : minimum width of wing tank in m under consideration measured inboard from the ship's side at right angles to the centreline at the level corresponding to the assigned summer freeboard.

h_i : minimum depth of the double bottom in m under consideration; where no double bottom is fitted h_i is to be taken equal to zero.

- (b) If a void space or segregated ballast tank of a length less than l_c as defined in (1) is located between wing oil tanks, O_c in formula (I) in (a)i) may be calculated on the basis of volume W_i being the actual volume of one such tank or the smaller of the two tanks adjacent to such space, multiplied by S_i as defined below and taking for all other wing tanks involved in such a collision the value of the actual full volume.

$$S_i = 1 - l_i/l_c$$

where

l_i : length of void space or segregated ballast tank under consideration.

- (c) Calculations in (a) above are to be done in accordance with the following i) to iii):
- i) Credit is only be given in respect of double bottom tanks which are either empty or carrying clean water where cargo oil is carried in the tanks above.
 - ii) Where the double bottom does not extend for the full length and width of the tank involved, the double bottom is considered nonexistent and the volume of the tanks above the area of the bottom damage is to be included in formula (II) or (III) of (a)i) even if the tank is not considered breached because of the installation of such a partial double bottom.
 - iii) Suction wells may be neglected in the determination of the value h_i , provided such wells are not excessive in area and extend below the tank for a minimum distance, and in no case more than half the height of the double bottom. If the depth of such a well exceeds half the height of the double bottom, h_i is to be taken equal to the double bottom height minus the well height. Piping serving such wells if installed within the double bottom is to be fitted with valves or other closing arrangements located at the point of connection to the tank served to prevent oil outflow in the event of damage to the piping. Such piping is to be installed as high from the bottom shell as possible.
- (3) Cargo tanks of oil tankers are to be of such size and arrangements that the hypothetical outflow O_c or O_s , calculated in accordance with the requirements of (2) any where in the length of the ship does not exceed $30,000m^3$ or $400\sqrt[3]{DW}$, whichever is the greater, but subject to a maximum of $40,000m^3$. However, for equipment capable of transferring oil from damaged cargo oil tank or tanks to a segregated ballast tank or a cargo oil tank with which sufficient ullage can be obtained, and that the cargo oil tank is fitted with a high oil suction device for an emergency, formula (III) of the provision in (2) may be used. It is conditional here that the equipment is capable of transferring oil in the quantity equivalent to half the largest capacity among damaged tanks in 2 hours of operation, and that the ballast tank or cargo oil tank can receive all of the said amount of oil. The piping for the high oil suction device is to be installed at an elevation greater than the vertical extent of bottom damage.

- (4) Individual cargo oil tanks are not to exceed the following size:

- (a) The volume of any one wing cargo oil tank of an oil tanker is not to exceed 75% of the limits of the hypothetical oil outflow referred to in (3). The volume of any one center cargo oil tank is not to exceed $50,000m^3$. However, in segregated ballast oil tankers as defined in 3.2.3, the permitted volume of a wing cargo oil tank situated between two segregated ballast tanks, each exceeding l_c in length, may be increased to the maximum limit of hypothetical oil outflow provided that the width of the wing tanks exceeds t_c .
- (b) The length of each cargo tank is not to exceed 10m or one of the following values, whichever is the greater;

- i) Where no longitudinal bulkhead is provided inside the cargo tanks:

$$\left(0.5 \frac{bn}{B} + 0.1\right) L_f,$$

but not to exceed $0.2L_f$

- ii) Where a centreline longitudinal bulkhead is provided inside the cargo tanks:

$$\left(0.25 \frac{bn}{B} + 0.15\right) L_f$$

- iii) Where two or more longitudinal bulkheads are provided inside the cargo tanks:

- 1) for wing cargo tanks: $0.2L_f$
- 2) for centre cargo tanks:
 - a) if bn/B is equal to or greater than 1/5: $0.2L_f$
 - b) if bn/B is less than 1/5:

where no centreline longitudinal bulkhead is provided:

$$\left(0.5 \frac{bn}{B} + 0.1\right) L_f,$$

where a centreline longitudinal bulkhead is provided:

$$\left(0.25 \frac{bn}{B} + 0.15\right) L_f$$

“ bn ” is the minimum distance in m from the ship’s side to the outer longitudinal bulkhead of the tank in question measured inboard at right angles to the centreline at the level corresponding to the assigned summer freeboard.

- (5) In order not to exceed the volume limits established by the requirements of (3) and (4) and irrespective of the accepted type of cargo transfer system installed, where the system defined in (3) interconnects two or more cargo tanks, valves (including other similar closing devices) are to be provided, for separating the tanks from each other.
- (6) Lines of piping which are connected with cargo tanks in a position less than t_c from the ship’s side or less than v_s from the ship’s bottom are to be fitted with valves or similar closing devices at the point at which they open into any cargo oil tank.

Table 3-7 Extent of side damage

Direction	Extent of side damage
Longitudinal extent (l_c)	$1/3 L_f^{2/3}$ or $14.5m$, whichever is less
Transverse extent (t_c)	$B/5$ or $11.5m$, whichever is less (inboard from the ship’s side at right angles to the centreline at the level corresponding to the assigned summer freeboard)
Vertical extent (v_c)	From the moulded line of the bottom shell plating at centreline, upwards without limit

Table 3-8 Extent of Bottom Damage

Direction	Extent of side damage	
Direction	For $0.3 L_f$ from the forward perpendicular of the ship	Any other part of ship
Longitudinal extent (l_s)	$L_f/10$	$L_f/10$ or $5m$, whichever is less
Transverse extent (t_s)	$B/6$ or $10m$, whichever is less but not less than $5m$	$5m$
Vertical extent (v_s)	$B/15$ or $6m$, whichever is less, measured from the moulded line of the bottom shell plating at centreline	

3.2.2 Subdivision and Stability (Regulations 27 and 28 of Annex I)*

1 Every oil tanker is to comply with the subdivision and damage stability criteria as specified in 3.2.2-3 after the assumed side or bottom damage as specified in 3.2.2-2, for any operating draught reflecting actual partial or full load conditions consistent with trim and strength of the ship as well as specific gravities of the cargo. Such damage is to be applied to locations along the length of the ship as shown in the following (1) to (3) :

- (1) In tankers of more than $225m$ in length, anywhere in the ship’s length
- (2) In tankers of more than $150m$, but not exceeding $225m$ in length, anywhere in the ship’s length except involving either after or forward bulkhead bounding the machinery space located aft. The machinery space is to be treated as a single floodable compartment.
- (3) In tankers not exceeding $150m$ in length, anywhere in the ship’s length between adjacent transverse bulkheads with the exception of the machinery space. For tankers of $100m$ or less in length where all requirements in 3.2.2-3 cannot be fulfilled without materially impairing the operational qualities of the ship, the Society may allow relaxations from these requirements. Ballast conditions where the tanker is not carrying oil (excluding oil residues) in cargo tanks, is not to be considered.

2 The following requirements regarding the extent and the character of the assumed damage are to apply:

- (1) The extent of side damage is to be as shown in Table 3-9.
- (2) The extent of bottom damage is to be as shown in Table 3-10. However, for oil tankers of $20,000 tons$ deadweight and above, the damage assumptions specified in Table 3-10 are to be supplemented by the assumed bottom raking damage in accordance

with **Table 3-11**.

- (3) If any damage of lesser extent than the maximum extents of damage specified in (1) and (2) results in a more severe condition, such damage is to be assumed.
- (4) Where the damage involving transverse bulkheads is envisaged as specified in **3.2.2-1(1)** and (2), transverse watertight bulkheads are to be spaced at least at a distance equal to the longitudinal extent of assumed damage specified in (1) in order to be considered effective. Where transverse bulkheads are spaced at a lesser distance one or more of these bulkheads within such extent of damage are to be assumed as nonexistent for the purpose of determining flooded compartments.
- (5) Where the damage between adjacent watertight bulkheads is envisaged as specified in **3.2.2-1(3)**, no main transverse bulkhead or a transverse bulkhead bounding side tanks or double bottom tanks are to be assumed damaged, unless:
 - (a) the spacing of the adjacent bulkheads is less than the longitudinal extent of assumed damage specified in (1); or
 - (b) there is a step or a recess in a transverse bulkhead of more than 3.05m in length, located within the extent of penetration of assumed damage. The step formed by the after peak bulkhead and after peak tank top is not to be regarded as a step for the purpose of the requirements of **3.2.2**.
- (6) If pipes, ducts or tunnels are situated within the assumed extent of damage, arrangements are to be made so that progressive flooding cannot thereby extend to compartments other than those assumed to be floodable for each case of damage.

Table 3-9 Extent of Side Damage

Direction	Extent of side damage
Longitudinal extent	$1/3L_f^{2/3}$ or 14.5m, whichever is less
Transverse extent	$B/5$ or 11.5m, whichever is less (inboard from the ship's side at right angles to the centreline at the level of the summer load line)
Vertical extent	From the moulded line of the bottom shell plating at centreline, upwards without limit.

Table 3-10 Extent of Bottom Damage

Direction	Extent of side damage	
	For $0.3L_f$ from the forward perpendicular of the ship	Any other part of ship
Longitudinal extent	$1/3L_f^{2/3}$ or 14.5m, whichever is less	$1/3L_f^{2/3}$ or 5m, whichever is less
Transverse extent	$B/6$ or 10m, whichever is less	$B/6$ or 5m, whichever is less
Vertical extent	$B/15$ or 6m, whichever is less, measured from the moulded line of the bottom shell plating at centreline	

Table 3-11 Extent of Bottom Raking Damage

Direction	Extent of damage
Longitudinal extent	ships of 75,000 tonnes deadweight and above : $0.6L_f$ measured from the forward perpendicular
	ships of less 75,000 tonnes deadweight : $0.4L_f$ measured from the forward perpendicular
Transverse extent	$B/3$ anywhere in the bottom
Vertical extent	breach of the outer hull

3 Oil tankers are to be regarded as complying with the damage stability criteria if the following requirements as shown (1) to (5) are met:

- (1) The final waterline, taking into account sinkage, heel and trim, are to be below the lower edge of any opening through which progressive flooding may take place. Such openings are to include air pipes and those which are closed by means of weathertight

doors or hatch covers and may exclude those openings closed by means of watertight manhole covers and flush scuttles, small watertight cargo tank hatch covers which maintain the high integrity of the deck, remotely operated watertight sliding doors, hinged watertight access doors with open/closed indication locally and at the navigation bridge of the quick-acting or single-action type that are normally closed at sea, hinged watertight doors that are permanently closed at sea, and side scuttles of the non-opening type.

- (2) In the final stage of flooding, the angle of heel due to unsymmetrical flooding is not to exceed 25 *degrees*, provided that this angle may be increased up to 30 *degrees* if no deck edge immersion occurs.
- (3) It may be regarded as sufficient if the righting lever curve has at least a range of 20 *degrees* beyond the position of equilibrium in association with a maximum residual righting lever of at least 0.1*m*. The area within this range below the curve is to be 0.0175*m* · *radian* or more. Except for the case in which the relevant compartments are assumed flooded, unprotected openings are to be assumed not to immerse. Within this range, all openings listed in (1) and other openings which can be closed with a weathertight cover may be accepted by the Society.
- (4) It is to be satisfied that the stability is sufficient during intermediate stages of flooding.
- (5) Even in cases where an equalizing system requiring the mechanical aid such as valves or inter-connecting pipes for the purpose of reducing the heel angle or of acquiring the minimum residual stability are provided for complying with the requirements in (1) to (3), such provisions are not to be taken into account, and sufficient residual stability is to be maintained in all stages of service of the equalizing system. Compartments connected through ducts with a large sectional area may be considered to be common.

4 The requirements in the preceding -1 above are to be confirmed by calculations which take into consideration the design characteristics of the ship, the arrangements, configuration and contents of the damaged compartments; and the distribution, specific gravities and the free surface effect of liquids. The calculations are to be based on the following requirements (1) through (5):

- (1) Account is to be taken of any empty or partially filled tanks, the specific gravity of cargoes carried as well as any outflow of liquids from damaged compartments.
- (2) The permeabilities are to be assumed as given in **Table 3-12**.
- (3) The buoyancy of any superstructure directly above the side damage is to be disregarded. The unflooded parts of superstructure beyond the extent of damage, however, may be taken into consideration provided that they are separated from the damaged space by watertight bulkheads and the requirements in the preceding 3.2.2-3(1) in respect of these intact spaces are complied with. Hinged watertight doors may be acceptable in watertight bulkheads in the superstructure.
- (4) The free surface effect is to be calculated at an angle of heel of 5 *degrees* for each individual compartment. The Society may require or allow the free surface corrections to be calculated at an angle of heel greater than 5 *degrees* for partially filled tanks.
- (5) In calculating the effect of free surface of consumable liquids it is to be assumed that, for each type of liquid at least one transverse pair or a single centerline tank has a free surface and the tank or combination of tanks to be taken into account is to be those where the effect of free surface is the greatest.

Table 3-12 Permeabilities

Spaces	Permeability
Appropriated to stores	0.60
Occupied by accommodation	0.95
Occupied by machinery	0.85
Voids	0.95
Intended for consumable liquids	0~0.95*
Intended for other liquids	0~0.95*

Note:

- * The permeability of partially filled compartment is to be consistent with the amount of liquid carries. Whenever damage extends to any tank carrying liquid, it is to be assumed that the content is totally flows out of the compartment replaced salt water up to the level of final plan of equilibrium.

5 Every oil tanker to which the requirements in this Part apply is to be provided with the following (1) and (2):

- (1) Information relative to loading and distribution of cargo necessary to ensure compliance with the requirements of 3.2.2; and
- (2) Data on the ability of the ship to comply with damage stability criteria as determined by 3.2.2, including the effect of relaxations that have been allowed under the preceding 3.2.2-1(3).

6 Oil tankers of 5,000 tonnes deadweight and above are to comply with the following intact stability criteria under the worst possible conditions of cargo and ballast loading during the liquid transfer operations. The liquid transfer operations specified in -6 and -7 means the transfer operations of liquid carried on board such as cargo loading/unloading, lightering, ballasting/deballasting, ballast water exchange and tank cleaning. However, this does not include asymmetric ballasting/loading where, in the ships with longitudinal bulkheads, all tanks on one side are empty and all tanks on the other side are slack/full.

- (1) At sea, the requirements in 2.2.1-1, Part U of the Rules is to be satisfied;
- (2) In port, the initial metacentric height G_0M is to be not less than 0.15m.

7 For combination carriers of 5,000 tonnes deadweight and above, instead of the compliance with the requirements of preceding -6, the information for intact stability during the liquid transfer operations as deemed appropriate by the Society may be prominently displayed in the approved stability booklet and at the cargo control station and in any computer by which stability calculations are performed, where installed.

8 All oil tankers are to be fitted with a stability instrument, capable of verifying compliance with intact and damage stability requirements, approved by the Administration having regard to the performance standards recommended by the IMO.

9 Notwithstanding the requirement in the preceding -8, a stability instrument installed on a ship at the beginning stage of construction before 1 January 2016 need not be replaced provided it is capable of verifying compliance with intact and damage stability to the satisfaction of the Administration.

10 In cases where the stability instrument is fitted in accordance with the requirements in the preceding -8 or -9, a document of approval for the stability instrument issued by the Administration is to be maintained on board.

11 The Administration may waive the requirements in the preceding -8 to -10 for the following ships, provided the procedures employed for intact and damage stability verification maintain the same degree of safety, as being loaded in accordance with the approved conditions:

- (1) Ships which are on a dedicated service, with a limited number of permutations of loading such that all anticipated conditions have been approved in the stability information provided in accordance with the requirements in -5;
- (2) Ships where stability verification is made remotely by a means approved by the Administration;
- (3) Ships which are loaded within an approved range of loading conditions; or
- (4) Ships at the beginning stage of construction before 1 January 2016 provided with approved limiting KG/GM curves covering all applicable intact and damage stability requirements.

3.2.3 Segregated Ballast Tanks (Regulation 18 of Annex I)*

Every crude oil tanker of 20,000 tonnes deadweight and over and products carrier of 30,000 tonnes deadweight and over are to be provided with segregated ballast tanks of the following capacities and arrangements. However, it is no need to comply with the provisions of following requirements in (2) where the paragraph 3.2.4 is applied:

- (1) The capacity of the segregated ballast tanks in all cases of ballast conditions including the lightweight plus segregated ballast only are to be such that the ship's draughts and trim can meet each of the following requirements (a) to (c). However, the segregated ballast conditions for oil tankers less than 150m in length are to be to the satisfaction of the Society.
 - (a) the moulded draught amidships (dm) in m (without taking into account any ship's deformation) is to be not less than:

$$2.0 + 0.02L_f$$
 - (b) the draughts at the forward and after perpendiculars are to correspond to those determined by the draught amidships (dm) as specified in (a) of this paragraph, in association with the trim by the stern of not greater than $0.015L$: and
 - (c) in any case the draught at the after perpendicular is not to be less than that which is necessary to obtain full immersion of the propeller (s).
- (2) The segregated ballast tanks situated within the cargo oil spaces are to meet the following requirements (a) to (c) to provide a measure of protection against oil outflow in the event of grounding or collision:
 - (a) The segregated ballast tanks and enclosed spaces other than cargo oil tanks within the cargo tank length (L_t) are to be so arranged as to comply with the following requirements:

$$\sum PAC + \sum PAs \geq J[L_t(B + 2D)]$$

where

PAC : the side shell area in m^2 for each segregated ballast tank or space other than an oil tank based on projected moulded dimensions,

PAs : the bottom shell area in m^2 for each such tank or space based on projected moulded dimensions,

L_t : length in m between the forward and after extremities of the cargo tanks,

D : moulded depth in m measured vertically from the top of the keel to the top of the freeboard deck beam at side amidships. In ships having rounded gunwales, the moulded depth is to be measured to the point of intersection of the moulded lines of the deck and side shell plating, the lines extending as though the gunwale were of angular design,

J : 0.45 for oil tankers of 20,000 *tonnes* deadweight, 0.30 for oil tankers of 200,000 *tonnes* deadweight and above, subject to the provisions of paragraph (b) of this regulation.

For intermediate values of deadweight the value of J are to be determined by linear interpolation.

- (b) For oil tankers of 200,000 *tonnes* deadweight and over, the value of J may be reduced as follows:

$$J_{reduced} = \left[J - \left(a - \frac{O_C + O_S}{4O_A} \right) \right] \text{ or } 0.2, \text{ whichever is the greater}$$

where

a : 0.25 for oil tankers of 200,000 *tonnes* deadweight;

0.40 for oil tankers of 300,000 *tonnes* deadweight;

0.50 for oil tankers of 420,000 *tonnes* deadweight and above

For oil tankers of intermediate deadweight tonnage between the above, the value of a is to be determined by linear interpolation

O_C and O_S : the values specified in [3.2.1\(2\)](#)

O_A : allowable oil outflow specified in [3.2.1\(3\)](#)

- (c) For determining PAC and PAs for enclosed spaces other than segregated ballast tanks and cargo oil tanks, the requirements in the following **i)** and **ii)** are to be complied with :
- i) The width of a full-depth wing tank, a wing tank with a depth extending from other enclosed space or deck to the top of double bottom or other enclosed space is not to be less than $2m$. The width of a wing tank or other enclosed space is to be measured inboard from the ship side at right angles to the centreline of the ship. Any wing tank or other enclosed space with the minimum width of less than $2m$ is not to be considered in determining PAC .
 - ii) The minimum vertical depth of each double bottom tank or other enclosed space is not to be less than $B/15$ or $2m$, whichever is less. Double bottom tanks or other enclosed spaces with the minimum depth of less than the above value are not considered in determining PAs . The minimum width and minimum depth of wing tanks or double bottom tanks are to be measured clear of the bilge area and, in the case of minimum width, are to be measured clear of any rounded gunwale area.

3.2.4 Prevention of Oil Pollution in the Event of Collision or Stranding (Regulation 19 of Annex I)*

- (1) Every oil tanker of 5,000 *tonnes* deadweight and above is to comply with any one of the following requirements (a) to (c) :

- (a) The entire cargo tank length is to be protected by ballast tanks or spaces other than tanks that carry oil as follows:

- i) Wing tanks or spaces are to extend either for the full depth of the ship's side or from the top of the double bottom to the uppermost deck, disregarding a rounded gunwale where fitted. They are to be arranged such that the cargo tanks are located inboard of the moulded line of the side shell plating, nowhere less than the distance w which, as shown in [Fig. 3-4](#), is measured at any cross-section at right angles to the side shell, as specified below:

$$w = 0.5 + \frac{DW}{20,000} \text{ or } 2.0m, \text{ whichever is the lesser.}$$

However, the minimum value of $h = 1.0m$

- ii) At any cross-section the depth of each double bottom tank or space is to be such that the distance h between the bottom of the cargo tanks and the moulded line of the bottom shell plating measured at right angles to the bottom shell plating as shown in [Fig. 3-4](#) is not less than specified below:

$$h = B/15 \text{ or } 2.0m, \text{ whichever is the lesser.}$$

However, the minimum value of $h = 1.0m$

- iii) When the distances h and w are different at turn of the bilge area or at locations without a clearly defined turn of the bilge, the distance w is to have preference at levels exceeding $1.5h$ above the base line as shown in **Fig. 3-4**.
 - iv) On crude oil tankers of 20,000 *tonnes* deadweight and above and product carriers of 30,000 *tonnes* deadweight and above, the aggregate capacity of wing tanks, double bottom tanks, forepeak tanks and afterpeak tanks are not to be less than the capacity of segregated ballast tanks necessary to meet the requirements of **3.2.3(1)**. Wing tanks or spaces and double bottom tanks used to meet the requirements of **3.2.3(1)** are to be located as uniformly as practicable along the cargo tank length. Additional segregated ballast capacity provided for reducing longitudinal hull girder bending stress, trim, etc., may be located anywhere within the ship.
 - v) Suction wells in cargo tanks may protrude into the double bottom below the boundary line defined by the distance h provided that such wells are as small as practicable and the distance between the well bottom and bottom shell plating is not to be less than $0.5h$.
 - vi) Ballast piping and other piping such as sounding and vent piping to ballast tanks are not to pass through cargo tanks. Cargo piping and similar piping to cargo tanks are not to pass through ballast tanks. Exemptions to this requirement may be granted for short lengths of piping, provided that they are completely welded or equivalent.
- (b) The entire cargo tank length is to be protected by mid-deck plating, ballast tanks or spaces other than cargo and fuel oil tanks as follows:
- i) The cargo and vapour pressure exerted on the bottom shell plating forming a single boundary between the cargo and the sea is not to exceed the external hydrostatic water pressure as expressed by the following formula :

$$f \cdot h_c \cdot \rho_c \cdot g + 100 \cdot \Delta p \leq d_n \cdot \rho_s \cdot g$$
 where:
 - h_c : height of cargo in contact with the bottom shell plating in m
 - ρ_c : maximum cargo density in t/m^3
 - d_n : minimum operating draught under any expected loading condition in m
 - ρ_s : density of sea water in t/m^3
 - Δp : maximum set pressure of pressure/vacuum valve provided for the cargo tank in bars
 - f : safety factor = 1.1
 - g : standard acceleration of gravity = $9.81 m/sec.^2$
 - ii) Any horizontal partition necessary to fulfill the above requirements is to be located at a height of not less than $B/6$ or $6m$, whichever is the lesser, but not more than $0.6D$, above the base line where D is the moulded depth amidships.
 - iii) The location of wing tanks or spaces is to be as defined in **3.2.4(1)(a)i)** except that, below a level $1.5h$ above the baseline where h is as defined in **3.2.4(1)(a)ii)**, the cargo tank boundary line may be vertical down to the bottom plating, as shown in **Fig. 3-5**.
 - iv) On crude oil tankers of 20,000 *tonnes* deadweight and above and product carriers of 30,000 *tonnes* deadweight and above, the aggregate capacity of wing tanks, forepeak tanks and afterpeak tanks are to be comply with the requirements of **3.2.4(1)(a)iv)**.
 - v) Ballast piping and cargo piping are to be comply with the requirements of **3.2.4(1)(a)vi)**.
- (c) Other methods of design and construction of oil tankers may be accepted as alternatives to the requirements prescribed in **3.2.4(1)(a)**, provided that such methods ensure at least the same level of protection against oil pollution in the event of collision or stranding by the Society.
- (2) Oil tankers of less than 5,000 *tonnes* deadweight are to comply with the following requirements **(a)** and **(b)**:
- (a) Double bottom tanks or spaces in accordance with **3.2.4(1)(a)ii)** are to be arranged along the entire cargo tank length. However, the distance h specified in **3.2.4(1)(a)ii)** may comply with the following:

$$h=B/15 (m)$$
 However, the minimum value of $h=0.76m$ in the turn of the bilge area and at locations without a clearly defined turn of the bilge, the cargo tank boundary line is to run parallel to the line of the mid-ship flat bottom as shown in **Fig. 3-6**.
 - (b) The capacity of each cargo tanks is not to exceed $700m^3$ unless wing tanks or spaces in accordance with **3.2.4(1)(a)i)** are arranged along the entire cargo tank length. However, the distance w specified in **3.2.4(1)(a)i)** may comply with the

following:

$$w = 0.4 + \frac{2.4DW}{20,000} (m)$$

However, the minimum value of $h=0.76m$

- (3) Notwithstanding the requirement of 1.2.1-1, for an oil tanker of 500 gross tonnage and above, which is engaged in international voyages and which were at beginning stage of construction on and after 1 September 1984, oil is not to be carried in any space extending forward of a collision bulkhead located in accordance with 2.2.1.1-1 and -2, Part 1, Part C of the Rules for the Survey and Construction of Steel Ships. An oil tanker other than the above is not to carry oil in any space extending forward of the transverse plane perpendicular to the centreline that is located as if it were a collision bulkhead located in accordance with that requirement.

Fig. 3-4

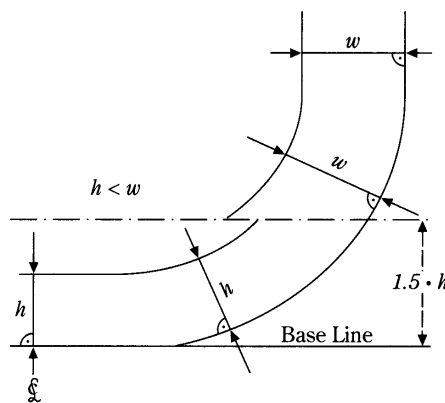
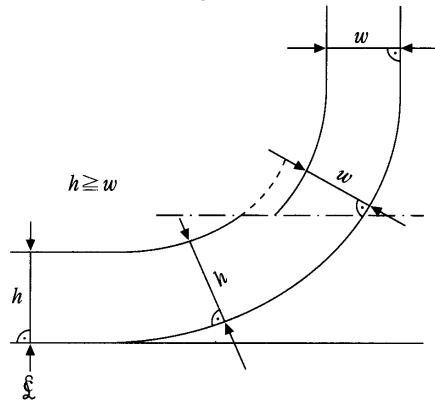

Fig. 3-5.

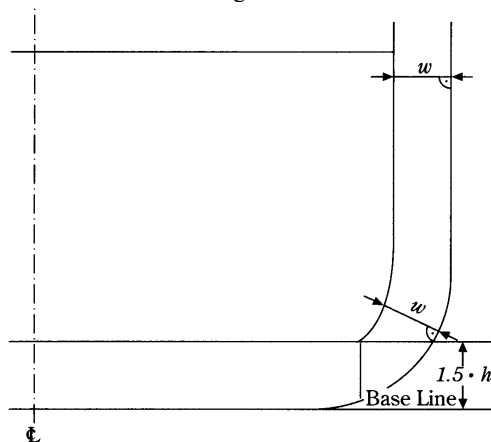
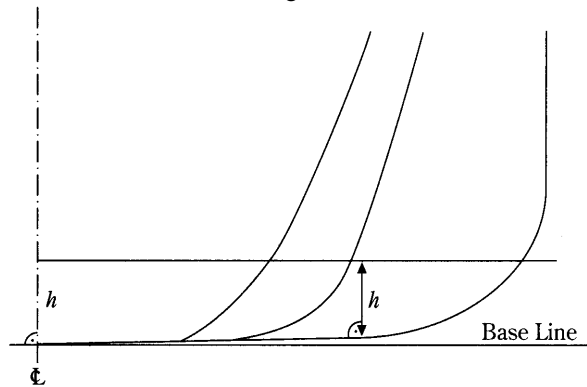

Fig. 3-6



3.2.5 Cargo Pump-room Protection (Regulation 22 of Annex I)*

1 The cargo pump-room of oil tankers of 5,000 tonnes deadweight and above is to be provided with a double bottom such that at any cross-section the depth of each double bottom tank or space shall be such that the distance h between the bottom of the pump-room and the ship's base line measured at right angles to the ship's base line is not to be less than specified below:

$$h = B/15(m) \text{ or}$$

$$h = 2 \text{ m, whichever is the lesser.}$$

However, the minimum value of $h = 1.0 \text{ m}$.

2 In case of cargo pump rooms whose bottom plate is located above the base line by at least the minimum height required in -1 above (e.g. gondola stern designs), there will be no need for a double bottom construction in way of the pump-room.

3 Ballast pumps, where provided within cargo pump-room, are to be provided with suitable arrangements to ensure efficient suction from double bottom tanks.

4 Notwithstanding the provisions of -1 and -2 above, where the flooding of the cargo pump-room would not render the ballast or cargo pumping system inoperative, a double bottom need not be fitted.

5 Bilge wells may penetrate into the double bottom provided that such wells are as small as practicable and the distance between the well bottom and the ship's base line measured at right angles to the ship's base line is not less than $0.5h$.

3.3 Installations and Piping Arrangements

3.3.1 Installations for the Retention of Oil On Board (Regulations 29, 31 and 32 of Annex I)*

1 Oil tankers of 150 gross tonnage and above are to be provided with appropriate cargo tank washing arrangements.

2 Oil tankers of less than 150 gross tonnage are to be provided with the arrangement for the retention of oily mixtures on board for subsequent discharge to reception facilities. However, where arrangements for the discharge of oil are provided in accordance with the requirements of 3.3, this requirement may be dispensed with.

3 Oil tankers of 150 gross tonnage and above are to be provided with the arrangement of at least one slop tank with a sufficient capacity necessary to retain the slops, oil residues and dirty ballast residues generated by tank washing, meeting the requirements of the following 3.3.1-4 through 3.3.1-9, and oil tankers over 70,000 tonnes deadweight are to be provided with the arrangements of at least two slop tanks. The total capacity of the slop tank is, except for the cases shown in the following (1) to (3), to be 3% or more of the oil-carrying capacity of the ship.

(1) The total capacity of the slop tank of any oil tanker where the amount of tank washings collected in one or more slop tanks is sufficient for carrying out further tank washing without any additional water, an eductor is provided, and the tank washing arrangement is capable of supplying a sufficient amount of eductor-driving fluid, is to be 2% or more.

(2) The total capacity of the slop tank of any oil tanker provided with the segregated tank arrangement in accordance with the requirements of 3.2.3, or any oil tanker provided with the crude oil washing system in accordance with the requirements of 3.4, is to be 2% or more.

However, the total capacity of the slop tank where the amount of tank washings collected in one or more slop tanks is sufficient for carrying out further tank washing without any additional water, an eductor is provided, and the tank washing arrangement is capable of supplying a sufficient amount of eductor-driving fluid, may be reduced to 1.5% or more.

- (3) The total capacity of slop tank of any combination carrier where cargo oil is carried exclusively in tanks with smooth wall surfaces, is to be 1% or more.

However, the total capacity of the slop tank where the amount of tank washings collected in one or more slop tanks is sufficient for carrying out further tank washing without any additional water, an eductor is provided, and the tank washing arrangement is capable of supplying a sufficient amount of eductor-driving fluid, may be reduced to 0.8% or more.

4 Slop tanks are to be so designed particularly in respect of the position of inlets, outlets, baffles or wires where fitted, so as to avoid excessive turbulence of oil or emulsion with the water.

5 Adequate means are to be provided for cleaning the cargo tanks and transferring the dirty ballast residue and tank washings from the cargo tanks into a slop tank.

6 The slop tank arrangement is to be provided with the oil discharge monitoring and control system for ballast water having the following performance, and approved to be appropriate by the Society.

- (1) A recording device to provide a continuous record of the discharge in *litres per nautical mile* and total quantity discharged, or the oil content and rate of discharge is to be incorporated in the system.
- (2) The record referred to in (1) is to be identifiable as to time and date.
- (3) The oil discharge monitoring and control system is to come into operation when there is any discharge of effluent into the sea.
- (4) The oil discharge monitoring and control system is to be provided with alarm devices which give visible and audible alarming when the instantaneous rate of discharge of oil exceeds 30 *litres per nautical mile*, when the total quantity discharged into the sea exceeds 1/30,000 of total quantity of cargo constituted in part by oil mixture in question or when failure of the oil discharge monitoring and control system is occur.
- (5) Any discharge of oil mixture is to be automatically stopped when alarm devices are activated. However, systems fitted to ships of less than 4,000 *tonnes* deadweight and at beginning stage of construction before 1 January 2005 may be exempted from this requirement.
- (6) A manually operated alternative method is to be provided and may be used in the event of failure of oil discharge monitoring and control system.

7 The piping arrangements for the oil discharge monitoring and control system are to conform with the provisions specified elsewhere.

8 Effective oil/water interface detectors considered to be appropriate by the Society are to be provided for an effective determination of the oil/water interface in slop tanks and in other tanks from which slops and effluent are directly discharged into the sea.

9 The ship is to be provided with an operation manual for the oil discharge monitoring and control system for ballast. The manual is to be approved by the Society.

10 The requirements in the preceding 3.3.1-3 to 3.3.1-9 do not apply to oil tankers carrying asphalt or other refined petroleum products falling under the requirements of this Part of the Rules, but the separation of water and such products is hard due to their physical properties. In this case, the oil tankers are to be provided with the arrangement for the retention of oily mixtures for subsequent discharge to reception facilities.

11 To any oil tanker engaged exclusively on voyages in special areas or arctic waters or engaged exclusively on voyages within 50 *nautical miles* from the territorial base line of a state, the requirements in the preceding 3.3.1-6 to 3.3.1-9 are not applied, provided that the Society can afford such relaxation in consideration of the operating plan of the ship.

3.3.2 Discharge Arrangements (Regulation 30 of Annex I)*

1 In every oil tanker, discharge manifolds for connection to reception facilities for the discharge of dirty ballast water or oil contaminated water are to be located on the open deck on both sides of the ship.

2 In every oil tanker, pipelines for the discharge to the sea of ballast water or water contaminated by oil in cargo tank spaces are to be led to the open deck or to the ship's side above the waterline in the deepest ballast condition, except that such water can be discharged by other pipelines in the following cases (1) or (2). However, tankers for which the date of contract for construction is on or after 1 October 2007 are to be provided with an overboard discharge outlet above the deepest ballast waterline.

- (1) The pipelines for the discharge of segregated ballast and clean ballast where means are provided for inspecting the surface of the ballast water immediately before discharging, and discharge is made within in-port areas or offshore mooring systems,

discharged at sea only by gravity or discharged at sea by pumps if the ballast water exchange is performed under methods deemed as appropriate by the Society.

- (2) The pipelines for the discharge of segregated ballast and clean ballast where oil/water interface detectors capable of inspecting the ballast water immediately before being discharged as specified in **3.3.1-8** are provided, and discharged at sea only by gravitation. Even in this case, however, pipelines for the discharge from slop tanks are to be led to the open deck or to the ship's side above the waterline in the deepest ballast condition.

3 Means are to be provided for stopping the discharge of effluent into the sea from a position on upper deck or above located so that the manifold in use referred to in the preceding **3.3.1-1** and the effluent from the pipeline referred to in the preceding **3.3.1-2** may be visually observed. Means for stopping the discharge need not be provided at the observation position if a positive communication system such as telephone or radio system is provided between the observation position and the discharge control position.

4 In addition to those specified in preceding **3.3.1-1** to **3.3.1-3** above, crude oil tankers of 20,000 *tonnes* deadweight and above and products carriers of 30,000 *tonnes* deadweight and above are to be provided with the following discharge arrangements specified in **(1)** and **(2)**:

- (1) Cargo oil pipelines are to be arranged so that the quantity of oil residue in the pipeline is minimized.
- (2) Means are to be provided so that the oil residues in the cargo pumps and cargo oil pipelines after cargo discharging can be drained or removed by connecting them with stripping lines or other effective means. For the oil residues, the special small diameter pipelines are to be provided outboard the shore transfer manifold for transferring them to the cargo oil tanks or slop tanks, as well as to shore reception facilities. The cross-sectional area of the small diameter pipelines are not to exceed 10% of that of the main cargo discharge line.

5 Every oil tankers of 150 *gross tonnage* and above which has installed a sea chest that is permanently connected to the cargo pipeline system, are to be equipped with both a sea chest valve and an inboard isolation valve. In addition to these valves, the sea chest is to be capable of isolation from the cargo piping system whilst the tanker is loading, transporting, or discharging cargo by use of an appropriate positive means. Such a positive means is to be a facility that is installed in the pipeline system in order to prevent, under all circumstances, the section of pipeline between the sea chest valve and the inboard valve being filled with cargo.

3.4 Crude Oil Washing System

3.4.1 Requirements for Installation (*Regulations 33 and 35 of Annex I*)

1 Crude oil tankers of 20,000 *tonnes* deadweight and over are to be provided with the following:

- (1) Crude oil washing system meeting the requirements in **3.4**
- (2) The inert gas system meeting the requirements of the Rules for the Survey and Construction of Steel Ships for all cargo oil tanks and slop tanks.
- (3) A procedures and arrangements manual describing the crude oil washing system in detail and specifying the handling procedure, which is approved by the Society.

2 Oil tankers other than those specified in **-1**, provided with crude oil washing systems are to comply with the requirements of **3.4**, except **3.4.3(2)**, **3.4.4(2)** to **(5)**, and **3.4.5(2)**, **(4)**, **(6)** and **(7)**.

3.4.2 Piping Arrangements for Crude Oil Washing System (*Annex 4.1 of A.446(XI)/A.497(XII)*)*

The piping arrangements for crude oil washing system are to meet the following requirements **(1)** through **(9)**:

- (1) The crude oil washing pipes and valves included in the supply piping system are to be made of steel or equivalent material, having a sufficient strength for the maximum working pressure, and to be connected and supported adequately.
- (2) The pipelines for the crude oil washing arrangement are to be permanent and independent from the fire main or other piping arrangements than the crude oil washing line. However, part of the cargo oil pipelines of the ship may be used in common with the crude oil washing line, where approved by the Society.

For combination carriers carrying non-liquid cargo, the crude oil washing pipelines may be made detachable as necessary, but when reused, they are to be fitted properly to a satisfactory oiltightness.

Where it is necessary to provide a tank washing machine in the tank hatch cover, a flexible hose is to be used for connecting the crude washing system with the tank washing machine. The flexible hose is to be of the flange type at joints, which is

approved by the Society. The length of the hose is not to exceed the length necessary for direct connection of the tank washing machine at a close position outside the hatch coaming. A storage area is to be provided for these flexible hoses when they are not in use.

- (3) Tank washing supply pipelines are to be provided with a means to prevent overpressure. The oil overflows through the safety device provided for preventing overpressure is to be led to the suction side of the supply pump.
- (4) Where the tank washing system is fitted with a water supply valve for water washing, the valve is to have sufficient strength, and if ingress of the crude oil into the washing system is likely, means are to be provided to shut-off the connected part by applying a blank flange.
- (5) Where the piping arrangement is fitted with pressure gauges or other instruments, a stop valve is to be provided near such instruments or the instruments are to be of the enclosed design.
- (6) No part of the crude oil washing system is to be located within the machinery space. Where steam heaters are provided for the tank washing system, these heaters are to be effectively shut off with a double stop valve or a readily identifiable blank flange.
- (7) Where supply pipelines serving in common with crude oil and water washing are provided, such pipelines are to be designed so that they can be drained of oil into slop tanks or other cargo spaces before starting water washing as far as practicable.
- (8) The pipelines are to have pipe diameters sufficient for simultaneous operations of the maximum number of tank washing machines at the design pressure and discharge rate specified in the operations and equipment manual. The pipelines are to be arranged so that necessary number of tank washing machines needed for individual cargo spaces can be operated simultaneously.
- (9) The crude oil washing supply pipelines are to be secured to the hull at adequate locations, and means are to be provided to allow thermal expansions and free movements according to the deflections of the hull structure. The securing method of the supply pipelines is to be such that the hydrodynamic impacts can be absorbed without displacing the pipelines to any appreciable extent. The securing positions of the pipelines are to be remotest from the supply position of crude oil to the pipelines. Where a tank washing machine is used for securing the branch pipe end, special means are to be provided for securing that portion of the pipelines when the tank washing machine is removed.

3.4.3 Crude Oil Washing Machines (Annex 4.2 of A.446(XI)/A.497(XII))*

Crude oil washing machines are to meet the following requirements (1) through (7):

- (1) Tank washing machines for crude oil washing are to be installed permanently, and to be of a design considered to be appropriate by the Society.
- (2) The performance characteristics of tank washing machines are to be determined by the nozzle diameter, operating pressure, operating mode and period. Individual tank washing machines are to have such performance characteristics that are sufficient to effectively wash the cargo tanks served by these washing machines within the period specified by the operations and equipment manual.
- (3) Tank washing machines are to be installed in individual cargo tanks, and the supporting method is to satisfy the Society. Where tank washing machines are installed at remarkably lower positions below the deck due to reasons of structural projections in the tank, consideration is to be given for providing special supports for the tank washing machines and supply pipelines.
- (4) Individual tank washing machines are to be capable of being shut off by the stop valve fitted to the supply pipeline. Where a deck-mount tank washing machine is removed for some reasons, means are to be provided to blank off the oil supply pipeline led to that machine while the machine is kept removed. Similarly, an adequate means to close the tank opening with a metal sheet or suitable other means approved by the Society is to be provided.
- (5) Where a driving unit is not incorporated into the tank washing machine, a sufficient number of tank washing machines are to be provided so that any tank washing machine needs not be transferred from the original position of installation for three or more times during the tank washing operation for achieving the tank washing programme specified in the operations and equipment manual.
- (6) The number and locations of tank washing machines are to be such as will ensure that all the vertical surfaces and all the horizontal surfaces can be washed by direct injections, or effective tank washing can be done by reflections of injection. For evaluating the effectiveness of reflected injections, special attention is to be paid to the washing of the upper horizontal surfaces, and to use the following parameters:
 - (a) For the horizontal surface of tank bottom and the upper surface of large principal structural hull members such as longitudinals in tanks, the sum of the areas that the direct injection is interfered with decks, bottom longitudinals, main

girders, longitudinals or similar other large structural hull members is not to exceed 10% of the total sum of areas of the horizontal surface of the tank bottom, and the upper surfaces of longitudinals and other large main structural hull members.

(b) For the vertical surfaces of tank side walls, the sum of the areas that the direct injection is interfered with decks, bottom longitudinals, main girders and longitudinals, or similar large main structural hull members is not exceed 15% of the total sum of the areas of the tank side walls. It is necessary to consider to provide two or more types of tank washing machines to achieve sufficient tank washing results though it depends on the arrangement of structural members in the tank.

(7) The design of deck-mounted tank washing machines is to be such that means are provided to display the rotational speed and arcing motions of the machine outside the cargo tank.

3.4.4 Pumps for Crude Oil Washing System (Annex 4.3 of A.446(XI)/A.497(XII))*

Pumps supplying crude oil to tank washing machines are to meet the following requirements (1) through (5):

- (1) Pumps supplying crude oil to tank washing machines are to be either the cargo oil pumps or those specially provided for the purpose.
- (2) The pump capacity is to be such that the maximum number of tank washing machines specified in the operations and equipment manual can be operated at the specified pressure with a sufficient rate of discharge. Where eductors are provided for stripping, the pump is to be capable of supplying the eductor-driving fluid sufficient to meet the requirements in 3.4.5(2).
- (3) The capacity of the pump is to be such that the requirement specified in (2) can be met even if one pump fails. The pump and piping arrangements are to be such that the crude oil washing system functions effectively even in the event of failure of one pump.
- (4) The system is to be capable of carrying out crude oil washing of tanks even when two or more types of different cargoes are carried.
- (5) Means are to be provided so that the washing machine can maintain a sufficient pressure according to (2) for effectively carrying out crude oil washing even in the event that the back pressure generated at shore reception facilities is lower than that required for crude washing. Even in the event of failure of one pump, this requirement is to be met. The minimum supply pressure required for crude oil washing is to be specified in the operations and equipment manual.

3.4.5 Stripping System (Annex 4.4 of A.446(XI)/A.497(XII))*

The stripping system is to meet the following requirements (1) through (7):

- (1) The design of all systems to strip crude oil from the bottom of cargo oil tanks is to satisfy the Society.
- (2) The design and capacity of the stripping system are to be such that no oil and residues are left stacking on the bottom of the tank when the tank washing is completed.
- (3) The capacity of the stripping system is to be such that 1.25 times the total amount of discharge by all tank washing machines simultaneously operated can be dealt with when tank washing is carried out on the bottom of the cargo tanks specified in the operations and equipment manual.
- (4) To check if the bottom of the cargo tank is dry after crude oil washing, means such as liquid level gauges, hand sounding devices, performance meter for stripping systems referred to in (6) are to be provided. Suitable arrangements for hand dipping must be provided at the aftermost portion of a cargo tank and in three other suitable locations unless other approved means are fitted for efficiently ascertaining that the bottom of every cargo tank is dry. The term “dry” used here means that even the area in the vicinity of the suction opening of stripping bears a small amount of oil, other areas are generally in dry condition.
- (5) For stripping oil from cargo oil tanks, displacement type pumps, selfpriming type centrifugal pumps, eductors or others satisfying the Society are to be used. Where stripping pipelines are connected to many tanks, means are to be provided to shut-off individually those tanks which cannot be stripped.
- (6) A monitoring system that monitors the effect of the stripping system is to be provided. The monitors are to be located in the cargo control room, safe, accessible and convenient places for watch-standing officers, and can be read off by remote indications. Where stripping pumps are provided, either a flow meter, stroke meter, or tachometer is to be provided as a monitoring device, and a pressure gauge or equivalent alternative device is to be fitted at the discharge connection of the pump. Where eductors are provided, pressure gauges at the suction and discharge connections of the eductor-driving fluid, and a compound gauge at the suction connection of the eductor are to be fitted as a monitor.
- (7) The internal structure of tank is to be such that the oil drain of the stripping system to the tank suction meets the requirements

of (2) and (4).

3.4.6 Ballast Tank Arrangement (*Annex 4.5 of A.446(XI)/A.497(XII)*)

Where no independent ballast tanks are provided for ballasting cargo tanks, means are to be provided to drain oil safely and effectively from the pump manifold and pipelines for ballasting, before ballasting is started.

Chapter 4 TRANSITIONAL REQUIREMENTS

4.1 General

4.1.1 Application*

1 The requirements in this chapter apply to construction and equipment for the prevention of pollution by oil from ships which were at beginning stage of construction before 25 August 1983, which are registered or intended to be registered in the Society, unless otherwise specified in the following of -3 and -4.

2 The ships falling under the requirements of this chapter are to comply with the requirements of **Chapter 1**, **Chapter 2** and **Chapter 3** as well in accordance with **Table 3-13**.

3 Oil tankers of 5,000 *tonnes* deadweight and above, which were constructed, the keels of which were laid, or which were delivered before the dates specified in **3.1.1-2** are to comply with the requirements of **4.3.10**. However, these requirements need not apply to the following oil tankers.

(1) Oil tankers comply with the requirements specified in **3.2.4**.

(2) Oil tankers comply with the requirements specified in **3.2.4(1)(a) i** and **ii** or **3.2.4(1)(b) i, ii** and **iii** or **3.2.4(1)(c)**. In that event, the side protection distances and bottom protection distances at centreline are to comply with the requirement specified in **2.6.1(2), Part S of the Rules for the Survey and Construction of Steel Ships** and **3.2.3(2)(c) ii** respectively.

4 Oil tankers, excluding ships specified in **-3(2)** above, of 600 *tonnes* deadweight and above carrying heavy grade oil as cargo regardless of the date of delivery are to comply with the requirements of **4.3.11** in addition to **4.3.10**. However, this requirement may not apply to oil tankers as deemed appropriate by the Society.

4.1.2 Definitions (*Regulations 1, 20 and 21 of Annex I*)*

For the purpose of this chapter, the following definitions apply:

(1) Ships other than oil tankers

(a) “*N* ship” means a ship to which either of the following **i**) to **iii**) falls under:

- i) for which the building contract is placed after 31 December 1975, or in the absence of a building contract the keel of which is laid after 30 June 1976; or
- ii) the delivery of which is after 31 December 1979; or
- iii) which has undergone a major conversion by either one of the following:
 - 1) for which the contract for conversion is placed after 31 December 1975; or
 - 2) in the absence of a contract, the conversion work of which is begun after 30 June 1976; or
 - 3) which is completed after 31 December 1979.

(b) “*E* ship” means a ship which is not an *N* ship.

(2) Oil tankers

(a) “*NN* ship” means a ship to which either of the following **i**) to **iii**) falls under:

- i) for which the building contract is placed after 1 June 1979, or in the absence of a building contract the keel of which is laid after 1 January 1980
- ii) the delivery of which is after 1 June 1982
- iii) which has undergone a major conversion:
 - 1) for which the contract for conversion is placed after 1 June 1982; or
 - 2) in the absence of a contract, the conversion work of which is begun after 1 January 1980; or
 - 3) which is completed after 1 June 1982.

(b) “*EN* ship” means a ship to which either of the following **i**) through **iv**) falls under:

- i) for which the building contract is placed between 31 December 1975 and 1 June 1979, or
- ii) in the absence of a building contract the keel of which is laid between 30 June 1976 and 1 January 1980, or
- iii) the delivery of which is between 31 December 1979 and 1 June 1982, or
- iv) which has undergone a major conversion:

- 1) for which the contract for conversion is placed between 31 December 1975 and 1 June 1979; or
 - 2) in the absence of a contract, the conversion work of which is begun between 30 June 1976 and 1 January 1980;
or
 - 3) which is completed between 31 December 1979 and 1 June 1982.
- (c) “*EE* ship” means a ship other than *NN* ship or *EN* ship.
- (3) “New ship” means an *N* ship, *NN* ship and *EN* ship.
 - (4) “Existing ship” means an *E* ship and *EE* ship.
 - (5) “Major conversion” means a conversion falls under one of the following (a) to (d). However, conversions for *EE* ships of 20,000 *tonnes* deadweight and over to make them comply with the requirements of 3.2.3 and 3.4.1 are not to be considered as a major conversion.
 - (a) which substantially alters the dimensions or carrying capacity of the ship; or
 - (b) which changes the type of the ship; or
 - (c) the intent of which in the opinion of the Society is substantially to prolong its life; or
 - (d) which otherwise so alters the ship that if it were a new ship, it would become subject to relevant requirements of **Part 1 of the Rules** not applicable to it as an existing ship
 - (6) “Heavy diesel oil” means marine diesel oil other than those distillates of which more than 50 % by volume distils at a temperature not exceeding 340°C when tested by the method acceptable to the Society.
 - (7) “Fuel oil” means heavy distillates or residues from crude oil or blends of such materials intended for use as a fuel for the production of heat or power of a quality equivalent to the specification acceptable to the Society.
 - (8) “Heavy grade oil” means any of the following:
 - (a) Crude oils having a density at 15°C higher than 900 kg/m³
 - (b) Oils, other than crude oils, having either a density at 15°C higher than 900 kg/m³ or a kinematic viscosity at 50°C higher than 180 mm²/s
 - (c) Bitumen, tar and their emulsions
 - (9) “Category 1 oil tanker” means an oil tanker of 20,000 *tonnes* deadweight and above carrying crude oil, fuel oil, heavy diesel oil or lubricating oil as cargo, and of 30,000 *tonnes* deadweight and above carrying oil other than the above, which does not comply with the requirements for *NN* ships.
 - (10) “Category 2 oil tanker” means an oil tanker of 20,000 *tonnes* deadweight and above carrying crude oil, fuel oil, heavy diesel oil or lubricating oil as cargo, and of 30,000 *tonnes* deadweight and above carrying oil other than the above, which complies with the requirements for *NN* ships. However, the oil tanker of 20,000 *tonnes* deadweight and above but less than 30,000 *tonnes* deadweight, which complied with the requirements specified in 3.2.3(1) and 3.2.3(2), is defined as “Category 2 oil tanker” and which not complied with the requirements specified in 3.2.3(1) and 3.2.3(2) is defined as “Category 1 oil tanker”.
 - (11) “Category 3 oil tanker” means an oil tanker of 5,000 *tonnes* deadweight and above but less than that specified in above (9) and (10).

Table 3-13 Applicability of the Requirements in Chapter 1, Chapter 2, and Chapter 3 to Ships Defined by 4.1.1-1

○: Applied ×: Not applied -: Outside the scope of application

		Ships other than		Oil tankers		
		Oil tankers		NN ship	EN ship	EE ship
		N ship	E ship			
Chapter 1 General	1.1.1	○	○	○	○	○
	1.1.2	○	×	○	×	×
	1.2.1-1	○	×	○	×	×
	1.2.1-2	○	×	○	○	×
	1.2.1-3	○	○	○	○	○
Chapter 2 Equipment for the prevention of pollution by oil from machinery spaces	2.2.1-1	○	○	○	○	○
	(1) and (2) of 2.2.2-1	○	×	○	○	×
	2.2.2 except for (1) and (2) of 2.2.2-1	○	○	○	○	○
	2.2.3	○	○	○	○	○
	2.3.1	○	○	○	○	○
	2.3.2	○	×	○	○	×
	2.3.3	○	×	○	○	×
	2.4.1	○	○	○	○	○
2.4.2	○	○	○	○	○	
Chapter 3 Construction and equipment for the prevention of pollution by oil carried in bulk	3.2.1-2	-	-	○	○	○
	3.2.2-1	-	-	○	○	×
	3.2.2-2	-	-	○	○	×
	3.2.2-3	-	-	○ ⁽¹⁾	○ ⁽¹⁾	×
	3.2.2-4	-	-	○	○	×
	3.2.2-5	-	-	○	○	×
	3.2.3	-	-	○	○ ⁽³⁾	×
	3.3.1	-	-	○	○	○
	3.3.2-1	-	-	○	○	○
	3.3.2-2	-	-	○	○	○
	3.3.2-3	-	-	○	○	×
	3.3.2-4(1)	-	-	○	×	×
	3.3.2-4(2)	-	-	○	○ ⁽⁴⁾	○ ⁽⁴⁾
	3.4.1	-	-	○	×	×
	3.4.2	-	-	○	○	○
3.4.3	-	-	○	○	○	
3.4.4	-	-	○	○	○	
3.4.5	-	-	○	○	○	
3.4.6	-	-	○	○	○	

Notes :

1 This does not apply to 3.2.2-3(3).

2 This applies to 3.4.1(3).

3 This does not apply to oil tankers of less than 70,000 tonnes deadweight.

4 This applies to crude oil tankers of 40,000 tonnes deadweight and above.

4.2 General Requirements

4.2.1 Arrangements of Forepeak (Regulation 16.3 of Annex I)

The requirements of **1.2.1-1** apply to ships for which the building contract is placed after 1 January 1982, or in the absence of the building contract which were at beginning stage of construction after 1 July 1982 among ships of 400 *gross tonnage* and above, *N* ships, *EN* ships and *NN* ships.

4.2.2 Storage and Discharge of Oil Residues (Sludge) (Regulation 12.2 of Annex I)

The requirements of **2.2.2** apply to *N* ships, *NN* ships and *EN* ships.

4.2.3 Oil Discharge Monitoring and Control System and Oily-water Separating for Bilge (Regulation 14.7 of Annex I)

The requirements of **2.3.3** also apply to *E* ships and *EE* ships. However, stopping of discharge may be carried out manually.

4.3 Equipment for the Prevention of Pollution by Oil Carried in Bulk by Oil Tankers

4.3.1 Arrangements of Bulkheads in Spaces Carrying Cargo Oil (Regulation 26.1 of Annex I)

The requirements of **3.2.1-2(3)** to **(6)** apply to *EE* ships which belong to either the following **(1)** or **(2)**, and these ships are to become satisfying the requirements until 2 October 1985.

- (1) Tankers the delivery of which is not later than 1 January 1977
- (2) Tankers to which both of the following conditions are applicable:
 - (a) the delivery of which is not later than 1 January 1977, and
 - (b) the building contract for which is placed after 1 January 1974. In the absence of an advance building contract which were at beginning stage of construction after 30 June 1974.

4.3.2 Subdivision and Stability (Regulation 28.3 of Annex I)

The following requirements are to apply to *NN* ships and *EN* ships instead of the requirements of **3.2.2-3(3)**. The stability in the final stage of flooding is to be investigated by the Society and may be regarded as sufficient if the righting lever curve has at least a range of 20 *degrees* beyond the position of equilibrium in association with a maximum residual righting lever of at least 0.1 *m*. The Society is to give consideration to the potential hazard presented by protected or unprotected openings which may become temporarily immersed within the range of residual stability.

4.3.3 Segregated Ballast Tanks (Regulation 18 of Annex I)

1 Under the conditions to comply with the requirements of **4.3.3-2**, all *EN* ships and *EE* ships of crude oil tankers of 40,000 *tonnes* deadweight and over are to be provided with segregated ballast tanks meeting the requirements of **3.2.3(1)**. However, the requirements of **3.2.3** apply to crude oil tankers of *EN* ships of 70,000 *tonnes* deadweight and above.

2 Except for ships that are intended to carry crude oil which does not fit to crude oil washing, the crude oil washing system meeting the requirements of **3.4** may be provided instead of providing segregated ballast tanks.

3 Product carriers of *EN* ships and *EE* ships of 40,000 *tonnes* deadweight and above are to be provided with segregated ballast tanks meeting the requirements of **3.2.3(1)**, or alternatively, clean ballast tanks meeting the requirements of **4.3.4**. However, the requirements of **3.2.3** apply to product carriers of *EN* ships of 70,000 *tonnes* deadweight and above.

4.3.4 Requirements for Oil Tankers Provided with Clean Ballast Tanks (Regulation 18.1 of Annex I)*

1 Clean ballast tanks under the requirements of **4.3.3-3** have sufficient capacities corresponding to segregated ballast tanks specified in **3.2.3**, and therefore they are to be used exclusively for carrying clean ballast water.

2 The arrangements and operating methods of clean ballast tanks are to meet the conditions as deemed appropriate by the Society.

3 Product carriers operated with the provisions of clean ballast tanks are to be provided with oil content meters approved by the Society so that the oil content of ballast water being discharged can be monitored.

4 All product carriers operated with the provisions of clean ballast tanks are to be provided with a clean ballast tank operations manual giving detailed explanations on the procedures and arrangements. This manual is to be approved by the Society and to contain all information in the specifications referred to in the preceding **4.3.3-2**.

4.3.5 Oil Tankers Engaged In Specific Trades (Regulation 2.5 of Annex I)*

Even in *EN* ships or *EE* ships of 40,000 *tonnes* deadweight and above, where they are operated with the limited trade areas approved by the Society, and are provided with tanks for the retention of all ballast water and tank washings including clean ballast

water, the requirements of 4.3.3 do not apply.

4.3.6 Oil Tankers Carrying Special Ballast (Regulation 18.10 of Annex I)*

Where deemed appropriate by the Society, *EN* ships and *EE* ships constructed to comply with the minimum draughts and trim conditions specified in 3.2.3(1) without using ballast water may be regarded as those meeting the requirements of segregated ballast tanks specified in 4.3.3.

4.3.7 Arrangements for the Retention of Oil On Board (Regulation 31.1 of Annex I)

1 For *EE* ships, the term “1/30,000” in applying the requirements of 3.3.1-6(4) may be construed as “1/15,000.”

2 For *EE* ships and *EN* ships of 40,000 tonnes deadweight and above, the requirements in 3.3.1-6 to 3.3.1-8 do not apply, provided that the Society so approves by taking into account their trade areas.

4.3.8 Discharge Arrangements (Regulation 30.6 of Annex I)

Although the requirements of 3.3.2-2 apply to *EN* ships and *EE* ships, the pipelines for discharge into the sea may be led to below the waterline when the following (1) or (2) is applicable:

- (1) Oil tankers operated with the provisions of clean ballast tanks, which cannot discharge ballast water from the clean ballast tanks at the position above the waterline without modifications, and are provided with oil content meters specified in 4.3.4-3; or
- (2) Where dirty ballast or oil contaminated water generated in the cargo tank space is led through permanent piping to such a position that part of the flow can be readily observed visually on the upper deck or other accessible position higher than the above. However, such a part flow indicating device is to be approved by the Society for the specification covering the design, installation and operation as a part flow system for overboard discharge monitoring.

4.3.9 Cargo Oil Piping Arrangements (Regulation 30.5 of Annex I)

EN ships or *EE* ships which are required to be provided with segregated ballast tanks, a crude oil washing system, or to be operated with the provisions of clean ballast tanks are to meet the requirements of 3.3.2-4(2). However, those ships already provided with pipelines in smaller pipe diameter, the required pipe diameter may be reduced to small diameter not exceeding 25% of the sectional area of the cargo oil discharge main.

4.3.10 Prevention of Accidental Oil Pollution (Regulation 20 of Annex I)*

1 A Category 2 or 3 oil tanker of 15 years and over after the date of its delivery may operate subject to the approval by the Society.

2 An oil tanker, excluding ships satisfied the conditions as deemed appropriate by the Society, is to comply with the requirements specified in 3.2.4 not later than the date specified in Table 3-14.

3 Notwithstanding the requirement of -2 above, the Society may allow continued operation of a Category 2 or 3 oil tanker beyond the date specified in Table 3-14, subject to the approval by the Society, provided that the operation is not go beyond the anniversary of the date of delivery of the ship in 2015 or the date on which the ship reaches 25 years after the date of its delivery, whichever is the earlier date.

4.3.11 Prevention of Oil Pollution from Oil Tankers Carrying Heavy Grade Oil as Cargo (Regulation 21 of Annex I)*

1 An oil tanker, excluding ships satisfied the conditions as deemed appropriate by the Society, of 600 tonnes deadweight and above carrying heavy grade oil as cargo is to comply with:

- (1) the requirements specified in 3.2.4 not later than 5 April 2005 if 5,000 tonnes deadweight and above; or
- (2) the requirements of 3.2.4(2)(a) and 3.2.4(1)(a)i) not later than the date of delivery of the ship in the year 2008 if 600 tonnes deadweight and above but less than 5,000 tonnes deadweight. However, the distance *w* specified in 3.2.4(2)(b) may be used in complying with requirement of 3.2.4(1)(a)i).

2 Notwithstanding the requirement of -1 above, the Society may allow continued operation beyond the date specified in -1 above subject to the approval by the Society, provided that the operation is not go beyond the date on which the ship reaches 25 years after the date of its delivery.

Table 3-14 Application Date of Oil Tankers

Category of Oil Tanker	Date or Year
Category 1 Oil Tanker	5 April 2005 for ships delivered on 5 April 1982 or earlier 2005 for ships delivered after 5 April 1982
Category 2 Oil Tanker and Category 3 Oil Tanker	5 April 2005 for ships delivered on 5 April 1977 or earlier 2005 for ships delivered after 5 April 1977 but before 1 January 1978 2006 for ships delivered in 1978 and 1979 2007 for ships delivered in 1980 and 1981 2008 for ships delivered in 1982 2009 for ships delivered in 1983 2010 for ships delivered in 1984 or later

Note: Year specified in the table, for example 2005, means the anniversary of the date of delivery of the ship in the year.

Part 4 CONSTRUCTION AND EQUIPMENT FOR THE PREVENTION OF POLLUTION BY DISCHARGES OF NOXIOUS LIQUID SUBSTANCES IN BULK

Chapter 1 GENERAL

1.1 General

1.1.1 Application

The requirements of this chapter apply to construction and equipment for the prevention of pollution by noxious liquid substances in bulk. However, the application of requirements of this Part may be deferred or modified where deemed appropriate by the Society taking into account each noxious liquid substance, subject to the approval by the Administration.

1.2 Definitions

1.2.1 Terminology (*Regulation 1 of Annex II*)

For the purpose of this Part, the following definitions apply:

- (1) "Clean ballast" means the ballast loaded in a tank which, since it was last used to carry a noxious liquid substance, has been treated in accordance with the one of the requirements of the following (a) through (d) depending upon the kind of noxious liquid substances and has been emptied.
 - (a) Where a substance in Category *X* is carried : to prewash or wash with cargo content confirmed and discharge the tank washings to shore reception facilities; to carry out additional washing and discharge the residue/water mixture resulting therefrom.
 - (b) Where a high viscosity or solidifying substance in Category *Y* is carried; to prewash and discharge the tank washings to shore reception facilities; to carry out additional washing and discharge the residue/water mixture resulting therefrom.
 - (c) Where a low viscosity or non-solidifying substance in Category *Y* or *Z* is carried: prewash after confirming that the amount of residues resulting from stripping becomes the specified value or less, and to discharge the residue/water mixture resulting therefrom.
 - (d) Remove the residues by ventilated washing.
- (2) "Bulk Chemical Code" means the Code for the Construction and Equipment of Ships Carrying Dangerous Chemicals in Bulk adopted by the Marine Environmental Protection Committee of *IMO* as a resolution *MEPC. 20(22)*, and was adopted in accordance with the procedure prescribed in Article 16 Amendments (an amendment to an Appendix to an Annex to the Convention) including valid amendments to the Code.
- (3) "Residue/water mixture" means the residues to which water has been added for any purpose (*e.g.* tank cleaning, ballasting, bilge slop).
- (4) "Associated pipeline" means the cargo discharge pipeline between the suction point in cargo tanks and the junction with the shore connection used for discharging cargo (including pumps and strainers), and other pipelines (including pumps and strainers) connected and open to the cargo discharge pipeline when discharging cargo.
- (5) "Solidifying substance" means, for noxious liquid substance with a melting point lower than 15°C, a substance whose temperature at cargo unloading is higher by less than 5°C than its own melting point; and for noxious liquid substance with a melting point of 15°C, or more, a substance whose temperature at cargo unloading is higher by less than 10°C than its own melting point.
- (6) "Non-solidifying substance" means a noxious liquid substance other than solidifying substances.
- (7) "High viscosity substance" means a noxious liquid substance in Category *X* or *Y* with a viscosity equal to or greater than

50mPa.s at the unloading temperature.

- (8) “Low viscosity substance” means a noxious liquid substance other than high viscosity substances.
- (9) “Category *X* noxious liquid substances” (hereinafter referred to as “Category *X* substances” in this Part) are substances, which are bioaccumulated and liable to produce a hazard to aquatic life or human health, listed in **Table S17.1 in Part S of the Rules for the Survey and Construction of Steel Ships** with an entry “*X*” in column ‘c’ of those tables or those provisionally assessed under the provisions of regulation 6.3 of Annex II of MARPOL 73/78 as Category *X* substances.
- (10) “Category *Y* noxious liquid substances” (hereinafter referred to as “Category *Y* substances” in this Part) are substances, which are bioaccumulated with a short retention of the order of one week or less, listed in **Table S17.1 in Part S of the Rules for the Survey and Construction of Steel Ships** with an entry “*Y*” in column ‘c’ those tables or those provisionally assessed under the provisions of regulation 6.3 of Annex II of MARPOL 73/78 as Category *Y* substances.
- (11) “Category *Z* noxious liquid substances” (hereinafter referred to as “Category *Z* substance” in this Part) are substances, which are slightly toxic to aquatic life, listed in **Table S17.1** and **Table S18.1 in Part S of the Rules for the Survey and Construction of Steel Ships** with an entry “*Z*” in column ‘c’ of those tables or those provisionally assessed under the provisions of regulation 6.3 of Annex II of MARPOL 73/78 as Category *Z* substances.
- (12) “Depth of water” means the charted depth.
- (13) “Vegetable oils” are substances listed in **Table S17.1 in Part S of the Rules for the Survey and Construction of Steel Ships** with superscript “(k)” in column ‘e’ of those tables.
- (14) “Electronic record book” means a device or system, approved by the Administration, used to electronically record the required entries for discharges, transfers and other operations as required under this Part in lieu of a hard copy record book.
- (15) “Persistent floater” means a slick forming substance with the following properties:
- (a) Density: \leq sea water ($1,025 \text{ kg/m}^3$ at $20 \text{ }^\circ\text{C}$);
 - (b) Vapour pressure: $\leq 0.3 \text{ kPa}$;
 - (c) Solubility: $\leq 0.1 \%$ (for liquids) $\leq 10 \%$ (for solids); and
 - (d) Kinematic viscosity: $> 10 \text{ cSt}$ at $20 \text{ }^\circ\text{C}$.

Chapter 2 CONSTRUCTION AND EQUIPMENT

2.1 General

2.1.1 Application

The requirements of this chapter apply to noxious liquid substances in bulk.

2.2 Requirements for Installation of Construction and Equipment

2.2.1 Equipment for the Prevention of Discharge of Noxious Liquid Substances*

1 For noxious liquid substances in bulk, equipment for the prevention of discharge of noxious liquid substances specified in [Table 4-1](#) are to be provided according to the Category and physical properties of the noxious liquid substance to be carried, and sea areas for discharge.

2 For ships intending to remove residues of a noxious liquid substance with a vapour pressure exceeding $5kPa$ at $20^{\circ}C$ by ventilation, ventilated tank washing system is to be provided in addition to the equipment specified in the preceding [2.2.1-1](#).

Table 4-1 Equipment for the Prevention of Discharge of Noxious Liquid Substance

Classification of substances		Category X	Category Y		Category Z
Equipment	Sea area of discharge	Outside of Antarctic Area			
	Physical properties	All substances	High viscosity or solidifying property	Low viscosity or non-solidifying property	All substances
Prewash system		○	○	— ⁽¹⁾⁽⁴⁾	— ⁽¹⁾
Striping system		○	○	○	○
Discharge outlet below the waterline		○ ⁽²⁾	○ ⁽²⁾	○ ⁽²⁾	○ ⁽²⁾
Arrangements for discharge to reception facilities		○	○	○ ⁽³⁾	○ ⁽³⁾

Remark

○: to be provided

—: not required to be provided

Notes

- (1) If the unloading of a substance is not carried out in accordance with the Manual for procedures and arrangements for discharge of noxious liquid substance, a prewash shall be carried out.
- (2) Any ship which discharges only clean ballast may be exempted from this requirement.
- (3) Any ship which does not discharge unnecessary noxious liquid substances generated on board may be exempted.
- (4) A prewash is to be carried out for persistent floaters with melting points equal to or greater than $0^{\circ}C$, as identified by “16.2.7” in column 'o' of [Table S17.1 in Part S of Rules for the Survey and Construction of Steel Ships](#) in the sea areas indicated in *regulation 13.9 of Annex II*.

3 Notwithstanding the requirements of [2.2.1-1](#) and [2.2.1-2](#), the equipment for the prevention of discharge of noxious liquid substances required to be installed in ships complying with the requirements of the following (1) and (2) are segregated ballast tank and arrangements for discharge to reception facilities.

- (1) where it is intended to repeatedly carry in each tank only one of noxious liquid substances or compatible substance (this means one of noxious liquid substances requiring no tank cleaning for loading another substance which differs from the substance in question after its unloading).
- (2) where it is intended to discharge the washings generated by the tank cleaning carried out only before repairs or drydocking of the ship to suitable reception facilities.

4 Notwithstanding the requirements in the preceding 2.2.1-1 to 2.2.1-3 above, the equipment for preventing discharge of noxious liquid substances to be provided in ships carrying noxious liquid substances of which vapour pressure exceeds 5kPa at 20°C intending to remove the residues by ventilation are to be the ventilated washing system.

5 Ships are to be provided with the Manual for procedures and arrangements for discharge of noxious liquid substance, approved by the Society.

6 Ships are to be provided with the Cargo record book, recorded loading of cargo, internal transfer of cargo, unloading of cargo, cleaning and prewash of cargo tank, discharge into the sea of tank washings, ballasting of cargo tanks and discharge of ballast water from cargo tanks, etc. The Cargo record book, whether as a part of the ship's official logbook, as an electronic record book which is to be approved by the Administration taking into account the Guidelines developed by IMO, or otherwise, is to be in the form specified in Appendix II to Annex II.

2.2.2 Requirements for Ships Carrying Category X Substances, Category Y Substances or Category Z Substances (Regulation 11 of Annex II)*

Ships carrying Category X substances, Category Y substances or Category Z substances, at beginning stage of construction after 1 July 1986, are to comply with the requirements in **Part S of the Rules for the Survey and Construction of Steel Ships**. Ships carrying Category X substances, Category Y substances or Category Z substances, at beginning stage of construction before 1 July 1986, are to comply with the requirements of the Bulk Chemical Code applicable to ships specified in the requirements of the Code shown in **Table 4-2** according to the mode of service and date of construction.

Table 4-2 Requirements for Existing Ships Carrying Category X Substances, Category Y Substances or Category Z Substances

Mode of navigation	Date of keel laying or placing building contract	No. of applicable Bulk Chemical Code
Ships engage in international voyages	Ships whose building contract in placed before 2 November 1973	1.7.3
	Ships whose building contract in placed on and after 2 November 1973 and ships at beginning stage of construction before 1 July 1983	1.7.2
Ships other than the above	Ships at beginning stage of construction before 1 July 1983	1.7.3
	Ships at beginning stage of construction on and after 1 July 1983 before 1 July 1986	1.7.2

2.2.3 Requirements for Ships Carrying Vegetable Oils (Regulation 4 of Annex II)

Notwithstanding the provisions in 2.2.2, an Administration may exempt ships from the carriage requirements under **Part S of the Rules for the Survey and Construction of Steel Ships** or **Bulk Chemical Code** for ships certified to carry individually identified vegetable oils in **Table S17.1 in Part S of the Rules for the Survey and Construction of Steel Ships**, provided the ships complies with the following conditions:

- (1) Ships shall meet all requirements for ship type 3 as identified in 2.1.2(3) in **Part S of the Rules for the Survey and Construction of Steel Ships** except for cargo tank location.
- (2) Under this regulation, cargo tanks shall be located at the following distances inboard. The entire cargo tank length shall be protected by ballast tanks or spaces other than tanks that carry oils as follows:
 - (a) Wing tanks or spaces shall be arranged such that cargo tanks are located inboard of the moulded line of the side shell plating nowhere less than 760 mm.
 - (b) Double bottom tanks or spaces shall be arranged such that the distance between the bottom of the cargo tanks and the moulded line of the bottom shell plating is not less than B/15 (m) or 2.0 m at the centerline, whichever is the lesser. The minimum distance shall be 1.0 m.

Chapter 3 (Deleted)

(Deleted)

Chapter 4 EQUIPMENT FOR THE PREVENTION OF DISCHARGE OF NOXIOUS LIQUID SUBSTANCES

4.1 General

4.1.1 Application

1 The requirements of this chapter apply to equipment for the prevention of discharge of noxious liquid substances provided in ships carrying noxious liquid substances in bulk in accordance with the requirements of [Chapter 2](#).

2 Equipment for the prevention of discharge of noxious liquid substances is to meet the requirements of [1.3.1-5](#) to [1.3.1-8](#) in [Part D of the Rules for the Survey and Construction of Steel Ships](#).

4.2 Prewashing Systems (*Regulation 6 of Annex II*)

4.2.1 General*

Prewashing systems are to meet the requirements of [4.2.2](#) to [4.2.4](#) according to physical properties of the noxious liquid substances to be carried.

4.2.2 Washing Machines

1 Where Category *X* substances or solidifying substances are to be carried, washing machines are to be located at such positions as all of the tank surfaces can be washed by taking into account the washing fluid pressure, capacity and reach of injection flow; where Category *Y* substances are to be carried, washing machines are to be located at appropriate positions, so that tank washing is performed by rotary jets operated by a sufficiently high hydraulic pressure.

2 Washing machines are to have sufficient corrosion resistance against noxious liquid substances.

4.2.3 Pumps for Washing Machines

1 Pumps for washing machines are to be capable of supplying sufficient wash water that the washing machine in accordance with the requirements of [4.2.2-1](#) requires.

2 For minimizing the quantity of water in the tank during tank washing, means are to be provided to continuously discharge slops with a separate pump from the wash water pump specified in the preceding [4.2.2-1](#), and to encourage water flow running toward the suction point.

4.2.4 Wash Water Heating System

To ships intended to carry solidifying substances or those with a viscosity of $50\text{mPa}\cdot\text{s}$ or more at 20°C , the wash water heating system is to be provided so that washing can be done with hot water at a temperature of 60°C or more, unless the properties of all of such substances make the washing less effective.

4.3 Stripping System (*Regulation 5 of Annex II*)

4.3.1 General

The stripping system is to be capable of drawing the noxious liquid substances at the bottom of the tank either with a pump or with an eductor when the cargo tank is washed.

4.3.2 Capacity of Stripping System

The stripping system is to be capable of reducing noxious liquid substances to the volumes shown in [Table 4-3](#) according to the date of keel laying of the ship and the classified category of noxious liquid substance.

4.3.3 Blowing System*

For improving the capacity of the stripping system specified in the preceding [4.3.2](#) above, a blowing system may be provided.

Table 4-3 Capacity of Stripping System

Category of ship	The quantity of stripping residue		
	Category X substance	Category Y substance	Category Z substance
Ships at beginning stage of construction before 1 July 1983	0.3m ³ or less	0.3m ³ or less	0.9m ³ or less
Ships at beginning stage of construction on and after 1 July 1983 before 1 January 2007	0.1m ³ or less	0.1m ³ or less	0.3m ³ or less
Ships at beginning stage of construction on and after 1 January 2007	0.075m ³ or less	0.075m ³ or less	0.075m ³ or less

Remark

1. For a ship other than a chemical tanker constructed before 1 January 2007 which cannot meet the requirements for the pumping and piping arrangements for substance in Category Z referred to in [Table S18.1 in Part S of the Rules for the Survey and Construction of Steel Ships](#) no quantity requirement shall apply. Compliance is deemed to be reached if the tank is emptied to the most practicable extent

4.4 Discharge Arrangements below the Waterline

4.4.1 General

The underwater discharge arrangements are to be consisting of the overboard discharge outlets below the waterline, discharge pump and discharge pipelines.

4.4.2 Arrangements of Discharge Outlets (Regulation 12 of Annex II)

- 1 Ships certified to carry substances of Category X, Y or Z shall have an underwater discharge outlet. For ships constructed before 1 January 2007 and certified to carry substances in Category Z an underwater discharge outlet is not mandatory.
- 2 The underwater discharge system is to be located within the cargo area in the vicinity of the turn of bilge to prevent the redrawing of noxious liquid substance through the sea water intake of the ship.

4.4.3 Size of Discharge Outlets (Regulation 12 of Annex II)*

1 The underwater discharge arrangements are to be such that the residues or residue/water mixtures to be discharged into the sea do not pass through the ship's boundary layer. In this case, the diameter of the discharge outlet, when the discharge is made normal to the ship side shell plating, is to be not smaller than the value calculated by the following formula:

$$D = Q_D / 5L$$

where ;

D : minimum diameter of discharge outlet (m)

L : distance from forward perpendicular to discharge outlet (m)

Q_D : maximum rate of discharge selected at which the ship may discharge the noxious liquid substance through the discharge outlet of the ship (m^3/h)

2 When the discharge is directed at an angle to the ship side shell plating, the formula specified in 4.4.3-1 above is to be modified by substituting for Q_D the component of Q_D which is normal to the ship side shell plating.

4.4.4 Discharge Pumps

The discharge pump is to have a sufficient capacity for discharging residue/water mixture.

4.5 Arrangements for Discharge to Reception Facilities

4.5.1 General

1 The arrangements for discharge to reception facilities are to have a discharge manifold for connection to reception facilities for the discharge of noxious liquid substances, and are to be located on the open deck on both sides of the ship.

2 For ships intending to discharge the residue/water mixture generated by tank washing to reception facilities exclusively through the discharge arrangements of the ship, relaxation of the requirements of the preceding -1 above may be considered where the Society judges it to be appropriate.

4.6 Ventilated Washing System (*P&A Standards Appendix C*)

4.6.1 General

The ventilated washing system is to be comprised of a ventilation equipment and a device for confirmation.

4.6.2 Ventilation Equipment

The ventilation equipment is to meet the following requirements (1) through (5):

- (1) The capacity is to be such that an air jet reaching the bottom of the tank in consideration, and to have a capacity calculated from [Fig. 4-1](#) Jet penetration depth is to be compared against tank height.
- (2) The ventilation equipment is to be provided at the tank opening which is closest to the suction point of the tank or the tank sump.
- (3) Arrangements are to be made in such a way that an air jet is oriented to the tank sump or the suction point as far as practicable, and that direct impingement of the air jet onto the tank structural members can be avoided as far as practicable.
- (4) Means are to be provided so that the residues can be removed from the relevant pipelines drained.
- (5) The ventilation equipment is to be sufficiently corrosion resistant for the noxious liquid substances or inert gas.

4.6.3 Verification Device

The verification device is to be capable of confirming if visible residues are remaining in the tank and the effect of the ventilated washing either by a visual inspection or equivalent other means.

4.6.4 Application of the Rules for the Survey and Construction of Steel Ships

Where the residues are removed from the tank by means of the ventilated washing system, the safety hazard concerning the flammability and toxicity of the cargo is to be checked, and the requirements of 4.6 of this Part and the relevant requirements of the Rules for the Survey and Construction of Steel Ships are to be complied with.

4.7 Segregated Ballast Tanks

4.7.1 General*

The capacity of a segregated ballast tank is to be such that the draughts and trim of the ship meet the following requirements (1) to (3) where only the segregated ballast tank under consideration is filled with ballast water:

- (1) The moulded draught of the ship at midship is the value determined by the following formula or more:

$$1.550 + 0.023L_f \text{ (m)}$$
- (2) The aft trim is to be the value determined by the following formula or less:

$$1.600 + 0.013L_f \text{ (m)}$$
- (3) The propeller is to be totally immersed in water.

Fig. 4-1 Minimum Flow Rate as a Function of Jet Penetration Depth.

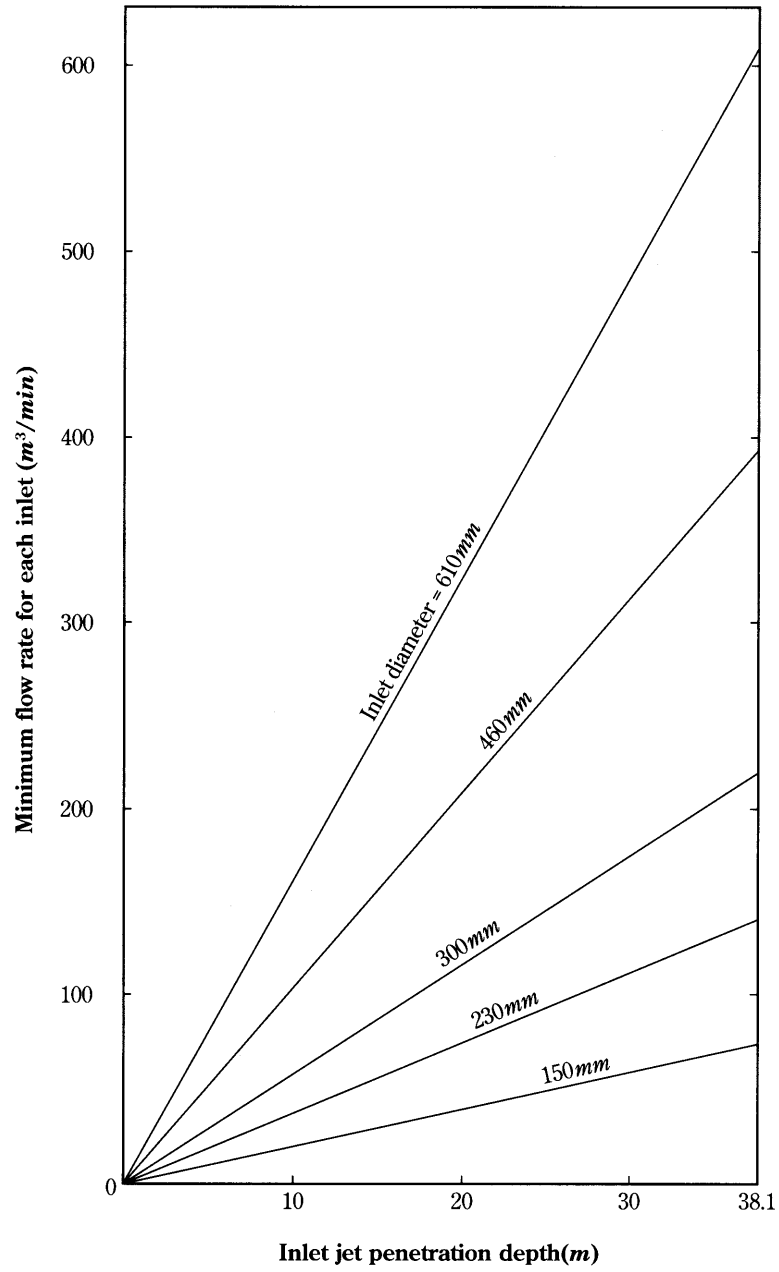

Part 5 SHIPBOARD OIL POLLUTION EMERGENCY PLANS

Chapter 1 GENERAL

1.1 General

1.1.1 Application

The requirements in this Part apply to Shipboard Oil Pollution Emergency Plans to be placed on board ships and offshore drilling rigs and other platforms used for the exploitation of sea-bed mineral resources.

1.1.2 Equipment Requirements

Every oil tanker of 150 *gross tonnage* and above, every ship other than an oil tanker of 400 *gross tonnage* and above and offshore drilling rigs and other platforms used for the exploitation of sea-bed mineral resources is to carry on board permanently a Shipboard Oil Pollution Emergency Plan approved by the Society in a place where it is ready for immediate use. However, unmanned non-self-propelled (UNSP) barges (as defined in [Part 3, 1.1.2\(9\)](#)) need not comply with this requirement.

Chapter 2 TECHNICAL REQUIREMENTS

2.1 General

2.1.1 Precautions for Preparation

Shipboard Oil Pollution Emergency Plans are to be prepared considering back ground information on the ship including type and size of the ship, cargo and trade routes so that they are realistic, practical, and easy to use.

2.1.2 Language

Shipboard Oil Pollution Emergency Plans are to be written in the working language of the master and officers of the ship. If the language used in the plan is not English, an English translation is to accompany it. For ships not engaged in international voyages, the case is to be dealt with as deemed appropriate by the Society.

2.2 Entries in Shipboard Oil Pollution Emergency Plans

2.2.1 Procedures to be Followed when Reporting an Oil Pollution Incident*

1 It is to be included in the plan that the master or other person having charge of the ship should inform without delay, of actual or probable discharge to the nearest coastal States.

2 The following items (1) through (7) are to be entered as the items to be reported:

- (1) Ship name, call sign, flag, size and type of the ship
- (2) Date and time of incident, position, course, speed
- (3) Radio station name, date and time of next report, type and quantity cargo/bunkers on board, shipper
- (4) Brief details of defects/deficiencies/damage
- (5) Brief details of pollution including type of oil, estimate of quantity lost, cause of spill, possibility of continued spill, sea and weather conditions
- (6) Contact details of ship's owner/operator/agent including postal address, telephone No. and facsimile No.
- (7) Post-spill actions taken and ship's movements

2.2.2 List of Authorities or Persons to be Contacted in the Event of an Oil Pollution Incident*

Coastal State contacts, port contacts and ship interest contacts, *e.g.* owners/operators, charterers, shippers, underwriters, who are to be contacted if the ship is involved in an oil pollution incident are to be listed and be included in the Appendices.

2.2.3 Actions to be Taken Immediately by Persons On Board the Ship to Reduce or Control the Discharge of Oil Following the Incident*

1 At least the following items (1) to (3) are to be entered for responding to operational spills:

- (1) A detailed description of the action to reduce or control the discharge of oil and persons in charge
- (2) Procedures for removal of oil spilled and for the proper disposal of removed oil and clean-up materials
- (3) Oil transfer procedures from the ship to another ship

2 At least the following items (1) to (3) are to be entered to respond to spills resulting from casualties:

- (1) Top priority is to be given to ensuring the safety of the personnel and the ship.
- (2) Detailed information on the damage sustained by the ship and the oil spill incident is to be collected and evaluated so that actions can be taken to prevent an escalation of the incident.
- (3) Detailed guidance for stability and stress considerations or a list of information needed for assessments at the owner's head office or other entity.

2.2.4 The Procedures and Point of Contact on the Ship for Coordinating Shipboard Activities with the National and Local in Combating the Pollution

1 It is to be included in the plan that the master and other person having charge of ships should contact the coastal State for authorization before actions are taken to mitigate a discharge.

2 Sufficient guidance for the master of the ship on oil pollution control operations to be developed under the initiative of the

owner is to be included.

3 Information on response systems and organizations of the coastal States along the trade route of the ship is to be included in the Appendices.

2.2.5 Other Information

The Society may request, in addition to the items specified in 2.2.1 to 2.2.4, other information that would be useful to the master of the ship when responding to an emergency situation.

2.3 Appendices to Shipboard Oil Pollution Emergency Plans*

In addition to the list specified in 2.2.2 and information shown in 2.2.4-3, the plans and data specified in the following (1) to (3) are to be appended to the Shipboard Oil Pollution Emergency Plan:

- (1) Plans including General Arrangement, Midship Section, piping diagrams such as Cargo Oil Lines considered to be used in dealing with an oil spill incident.
- (2) Summary flowchart to guide the master through the various actions and decisions required during an incident response.
- (3) Other items deemed necessary by the Society.

2.4 Additional Requirements for Oil Tankers of 5,000 tonnes Deadweight and above

2.4.1 Shore-based Support

All oil tankers of 5,000 tonnes deadweight or more are to have prompt access to computerised, shore-based damage stability and residual structural strength calculation programs.

Part 6 SHIPBOARD MARINE POLLUTION EMERGENCY PLAN FOR NOXIOUS LIQUID SUBSTANCES

Chapter 1 GENERAL

1.1 General

1.1.1 Application

The requirements in this Part apply to a Shipboard Marine Pollution Emergency Plan for Noxious Liquid Substances to be placed on board ships.

1.1.2 Equipment Requirements

Every ship of 150 *gross tonnage* and above certified to carry noxious liquid substances in bulk is to carry on board permanently a Shipboard Marine Pollution Emergency Plan for Noxious Liquid Substances approved by the Society in a place where it is ready for immediate use.

Chapter 2 TECHNICAL REQUIREMENTS

2.1 General

2.1.1 Precautions for Preparation

A Shipboard Marine Pollution Emergency Plan for Noxious Liquid Substances is to be prepared considering the many variables including type and size of the ship, cargo and trade routes at the preparation, and so that it is realistic, practical, and easy to use.

2.1.2 Language

A Shipboard Marine Pollution Emergency Plan for Noxious Liquid Substances is to be written in the working language understood by the master and officers of the ship. If the language used in the plan is not English, a English translation is to accompany it. For ships not engaged in international voyages, the Plan may be written in the language deemed appropriate by the Society.

2.1.3 Shipboard Marine Pollution Emergency Plan

In the case of ships to which the requirements specified in [Part 5](#) also apply, such a plan may be combined with the Shipboard Oil Pollution Emergency Plan required under [Part 5](#). In this case, the title of such a plan is to be "Shipboard Marine Pollution Emergency Plan".

2.2 Entries in Shipboard Marine Pollution Emergency Plan for Noxious Liquid Substances

2.2.1 Procedures to be Followed when Reporting a Noxious Liquid Substance Pollution Incident*

1 It is to be included in the plan that the master or other person having charge of the ship should inform of actual or probable discharge to the nearest coastal States without delay.

2 The following items (1) through (7) are to be entered as the items to be reported:

- (1) Ship name, call sign or ship station identity, flag, ship size and type
- (2) Date and time of incident, position, course, speed
- (3) Date and time of next report, type and quantity of cargo/bunkers on board, shipper
- (4) Brief details of defects/deficiencies/damage
- (5) Brief details of pollution including type of noxious liquid substance, estimate of quantity lost, cause of spill, possibility of continuation of spill, sea and weather conditions
- (6) Contact details of ship's owner/operator/agent including postal address, telephone No. and facsimile No.
- (7) Post-spill actions taken and ship's movements

2.2.2 List of Authorities or Persons to be Contacted in the Event of a Noxious Liquid Substance Pollution Incident*

Coastal State contacts, port contacts and ship interest contacts, who are to be contacted if the ship is involved in a noxious liquid substance pollution incident, e.g. owners/operators, charterers, shippers, underwriters, are to be listed and be included in the Appendices.

2.2.3 Actions to be Taken Immediately by Persons on Board the Ship to Reduce or Control the Discharge of Noxious Liquid Substance following the Incident*

1 At least the following items (1) to (3) are to be entered for responding to operational spills:

- (1) A detailed description of the action to reduce or control the discharge of noxious liquid substance, and persons in charge
- (2) Procedures for removal of the spilled noxious liquid substance and for proper disposal of the removed noxious liquid substance and clean-up materials
- (3) Procedures for transfer of the noxious liquid substance from the ship to another ship

2 At least the following items (1) to (3) are to be entered to respond to spills resulting from casualties:

- (1) Top priority is to be given to ensure the safety of the personnel and the ship.
- (2) Detailed information on the damage sustained by the ship and on the noxious liquid substance spill incident is to be collected and evaluated so that actions can be taken to prevent escalation of the incident.
- (3) Detailed guidance to consider stability and strength and a list of information needed for damage stability and strength assessments at the owner's head office or other similar places.

2.2.4 The Procedures and Point of Contact on the Ship for Coordinating Shipboard Activities with the National and Local Authorities in Combating the Pollution

1 It is to be included in the plan that the master of the ship or other person having charge on board the ship should contact the coastal State for authorization before actions are taken to mitigate a discharge.

2 Sufficient guidance for the master of the ship on noxious liquid substance pollution control operations to be developed under the initiative of the owner is to be included.

3 Information on response systems and organizations of the coastal States along the trade route of the ship is to be included in the Appendices.

2.2.5 Other Information

The Society may request, in addition to the items specified in 2.2.1 to 2.2.4, other information that would be useful to the master of the ship when responding to an emergency situation.

2.3 Appendices to Shipboard Marine Pollution Emergency Plan for Noxious Liquid Substances *

In addition to the list specified in 2.2.2 and information shown in 2.2.4-3, the plans and items specified in the following (1) to (3) are to be appended to a Shipboard Marine Pollution Emergency Plan for Noxious Liquid Substances :

- (1) Plans and diagrams including General Arrangement, Midship Section, piping diagrams such as Cargo Oil Lines considered to be used when dealing with noxious liquid substance spill incidents.
- (2) Summary flowchart to guide the master through the various actions and decisions required during an incident response.
- (3) Other items deemed necessary by the Society.

Part 7 EQUIPMENT FOR THE PREVENTION OF POLLUTION BY SEWAGE

Chapter 1 GENERAL

1.1 General

1.1.1 Application

1 The requirements in this chapter apply to the equipment for the prevention of pollution by sewage from ships.

2 For unmanned non-self-propelled (UNSP) barges, the following 2.2 need not be applied when exemptions are granted by Administrations.

1.1.2 Terminology (*Regulation 1 of Annex IV*)

For the purpose of the requirements in this part, the following definitions apply:

- (1) “New ship” means a ship:
 - (a) for which the building contract is placed, or, in the absence of a building contract, is at beginning of construction on or after 27 September 2003; or
 - (b) the delivery of which is on or after 27 September 2006.
- (2) “Existing ship” means a ship which is not a new ship.
- (3) “Sewage” means:
 - (a) drainage and other wastes from any form of toilets and urinals;
 - (b) drainage from medical premises (dispensary, sick bay, etc.) via wash basins, wash tubs and scuppers located in such premises;
 - (c) drainage from spaces containing living animals; or
 - (d) other waste waters when mixed with the drainage defined above.
- (4) “Holding tank” means a tank used for the collection and storage of sewage.
- (5) “From the nearest land” means from the baseline from which the territorial sea of the territory in question is established in accordance with international law, except the case off the north-eastern coast of Australia specified in *Regulation 1.5 of Annex IV*.
- (6) “Special area” means the following areas:
 - (a) The Baltic Sea Area
The Baltic Sea proper with the Gulf of Bothnia, the Gulf of Finland and the entrance to the Baltic Sea bounded by the parallel of the Skaw in the Skagerrak at 57°44.8 N.
 - (b) Any other sea area than (a) above, designated by the *IMO* in accordance with criteria and procedures for designation of special areas with respect to prevention of pollution by sewage from ships.
- (7) “Person” means member of the crew and passengers.
- (8) “Passenger ship” means a ship which carries more than 12 passengers where a passenger is every person other than the following (a) and (b):
 - (a) the master and the members of the crew or other persons employed or engaged in any capacity on board a ship on the business of that ship; and
 - (b) a child under one year of age.
- (9) “New passenger ship” is a passenger ship:
 - (a) for which the building contract is placed, or in the absence of a building contract, the keel of which is laid, or which is in similar stage of construction, on or after 1 June 2019. For this purpose, the wording “a similar stage of construction” means the stage which falls under (a) and (b) of 2.1.1(25), Part 1; or

- (b) the delivery of which is on or after 1 June 2021.
- (10) “Existing passenger ship” is a passenger ship which is not a new passenger ship.
- (11) “Unmanned non-self-propelled (UNSP) barge” means a barge that:
 - (a) is not propelled by mechanical means;
 - (b) has neither persons nor living animals on board;
 - (c) is not used for holding sewage during transport; and
 - (d) has no arrangements that could produce sewage.

Chapter 2 EQUIPMENT FOR THE PREVENTION OF POLLUTION BY SEWAGE FROM SHIPS

2.1 General

2.1.1 Application (Regulation 2 of Annex IV)

1 The requirements of this chapter apply to the following ships engaged in international voyages:

- (1) new ships of 400 *gross tonnage* and above;
- (2) new ships of less than 400 *gross tonnage* which are certified to carry more than 15 *persons*; and
- (3) existing ships of 400 *gross tonnage* and above, on 27 September 2008; and
- (4) existing ships of less than 400 *gross tonnage* which are certified to carry more than 15 *persons*, on 27 September 2008; and

2 Existing ships at beginning stage of construction before 2 October 1983 according to (3) and (4) of -1 above are to be equipped, as far as practicable, to discharge sewage in accordance with the requirements of 2.2.1.

2.2 Requirements for Installation of Equipment

2.2.1 Equipment for the Prevention of Pollution by Sewage (Regulation 9, Regulation 10 and Regulation 11 of Annex IV)*

For ships specified in 2.1.1-1, the equipment listed in the following (1) to (3) is to be installed for the prevention of pollution by sewage.

- (1) Sewage systems:
 - (a) One of the following i) to iii):
 - i) a sewage treatment plant as deemed appropriate by the Society;
 - ii) a sewage comminuting and disinfecting system as deemed appropriate by the Society, accompanied with facilities to the satisfaction to the Society for the temporary storage of sewage when the ship is less than 3 nautical miles from the nearest land; or
 - iii) a holding tank of the capacity to the satisfaction of the Society for the retention of all sewage, having regard to the operation of the ship, the number of persons on board and other relevant factors. The holding tank is to be constructed to the satisfaction of the Society and to have a means to indicate visually the amount of its contents.
 - (b) Notwithstanding (a) above, the following i) or ii) in the case of passenger ships operating within a special area on or after a date determined by the *IMO*; however, this date is to in no event be prior to 1 June 2019 for new passenger ships and prior to 1 June 2021 for existing passenger ships.
 - i) a sewage treatment plant as deemed appropriate by the Society; or
 - ii) a holding tank as specified in (a)iii) above.
- (2) A pipeline to discharge sewage to a reception facility.
- (3) A standard discharge connection fitted for the pipeline specified in (2) in accordance with Table 7-1. For ships in dedicated trades, i.e. passenger ferries, alternatively the ship's discharge pipeline may be fitted with a discharge connection which can be accepted by the Administration, such as quick-connection couplings.

Table 7-1 Standard Dimensions of Flanges for Discharge Connections

Description	Dimension
Outside diameter	210 mm
Inner diameter	According to pipe outside diameter*
Bolt circle diameter	170 mm
Slots in flange	4 holes 18 mm in diameter equidistantly placed on a bolt circle of the above diameter slotted to the flange periphery. The slot width to be 18 mm.
Flange thickness	16 mm
Bolts and nuts: quantity and diameter	4, each of 16 mm in diameter and of suitable length
The flange is designed to accept pipes up to a maximum internal diameter of 100 mm and is to be of steel or other equivalent material having a flat face. This flange, together with a suitable gasket, is to be suitable for a service pressure of 0.6 MPa.	

Remarks:

*For ships having a moulded depth of 5 m and less, the inner diameter of the discharge connection may be 38 mm.

Part 8 EQUIPMENT FOR THE PREVENTION OF AIR POLLUTION FROM SHIPS

Chapter 1 GENERAL

1.1 General

1.1.1 Application (Regulation 1 and 3 of Annex VI)

1 The requirements in this Part apply to the equipment for the prevention of air pollution from ships.

2 Notwithstanding the -1, emissions from mobile offshore drilling units, etc. directly arising from the exploration, exploitation and associated offshore processing of sea-bed mineral resources may be exempted from the provisions of this Part. Such emissions include the followings:

- (1) Emissions resulting from the incineration of substances that are solely and directly the result of exploration, exploitation and associated offshore processing of sea-bed mineral resources, including but not limited to the flaring of hydrocarbons and the burning of cuttings, muds, and/or stimulation fluids during well completion and testing operations, and flaring arising from upset conditions.
- (2) The release of gases and volatile compounds entrained in drilling fluids and cuttings.
- (3) Emissions associated solely and directly with the treatment, handling, or storage of sea-bed minerals.
- (4) Emissions from diesel engines that are solely dedicated to the exploration, exploitation and associated offshore processing of sea-bed mineral resources.

3 For unmanned non-self-propelled (UNSP) barges, the following 1.2.1, 2.1, 2.2 and 2.4 need not be applied when exemptions are granted by Administrations.

1.1.2 Terminology (Regulation 2, 13, 14 and 16 of Annex VI and 1.3, 4.1, 4.3.9 and 4.4.8 of NOx Technical Code)*

For the purpose of the requirements in this Part, the following definitions apply unless specified otherwise in Chapters 2 or 3:

- (1) “NOx Technical Code” means the Technical Code on Control of Emission of Nitrogen Oxides from Marine Diesel Engines adopted by the International Conference of Parties to MARPOL 73/78 in 1997 as resolution 2, as amended by the IMO, provided that such amendments are adopted and brought into force in accordance with the provisions of article 16 of the present Convention.
- (2) “Ozone depleting substances” means controlled substances defined in paragraph 4 of article 1 of the Montreal Protocol on Substances that Deplete the Ozone Layer, 1987, listed in Annexes A, B, C or E to the said Protocol.
- (3) “Marine pollutant” means those substances subject to Annex III of MARPOL 73/78.
- (4) “Diesel engine manufacturer, etc.” means the engine manufacturer, etc. specified in 1.2.1(4) of the Rules for Marine Engine Emission Verification.
- (5) “Engine Family” means a series of diesel engines to which the guidance specified in 4.3.8 of the NOx Technical Code applies. These diesel engines are series produced, proven to have similar NOx emission characteristics through their design, used as produced, and, during installation on board, and require no adjustments or modifications which could adversely affect the NOx emissions.
- (6) “Engine Group” means a series of diesel engines to which the guidance specified in 4.4.6 of the NOx Technical Code applies. These diesel engines form a smaller series, produced for similar engine application, and may require minor adjustments and modifications during installation or in service on board.
- (7) “Parent Engine” means a diesel engine selected as the one which has the highest NOx emission level among all of the diesel engines in an Engine Family in accordance with the provisions specified in 4.3.9 of the NOx Technical Code and that chosen for the Engine Group in accordance with the provisions specified in 4.4.8 of the NOx Technical Code.
- (8) “Components” of a diesel engine mean those interchangeable parts which influence the NOx emissions performance, identified

by their design/parts number.

- (9) “Operating values” of a diesel engine mean engine data, like cylinder peak pressure, exhaust gas temperature, etc., from the engine log which are related to the NO_x emission performance. These data are load-dependent.
- (10) “Technical File” means a record containing all details of parameters, including components and settings of a diesel engine, which may influence the NO_x emission of the engine.
- (11) “Setting” of a diesel engine means adjustment of an adjustable feature influencing the NO_x emissions performance of a diesel engine.
- (12) “Substantial modification” of a diesel engine means as follows.
- (a) For diesel engines installed on ships at beginning stage of construction on or after 1 January 2000 (19 May 2005 for ships not engaged in international voyages), substantial modification means any modification to an engine that could potentially cause the NO_x emission from the engine to exceed the limits specified in **2.1.2-1**. Routine replacement of components of a diesel engine by parts specified in the Technical File that do not alter NO_x emission characteristics is not be considered a “substantial modification”.
 - (b) For diesel engines installed on ships at beginning stage of construction before 1 January 2000 (19 May 2005 for ships not engaged in international voyages), substantial modification means any modification made to an engine which increases its existing NO_x emission characteristics in excess of the limits established by the on-board simplified measurement method referred to in **2.1.2-2(2)(b)**. These changes include, but are not limited to, changes in its operations or in its technical parameters (e.g., changing camshafts, fuel injection systems, air systems, combustion chamber configuration, or timing calibration of the engine). However, the installation of a certified approved method pursuant to **2.1.1-3** or certification pursuant to **2.1.2(1)(a)** to **(c)** is not considered to be a substantial modification for the purpose of the application of **(13)** and **2.1.2-1(2)**.
- (13) “Major conversion” of a diesel engine means a modification of a diesel engine on or after 1 January 2000 (19 May 2005 for ships not engaged in international voyages) which corresponds to any of the following **(a)** to **(c)**.
- (a) The engine is replaced or supplemented with a non-identical diesel engine manufactured.
 - (b) Any substantial modification of a diesel engine is made to the engine.
 - (c) The maximum continuous output (referred to in **2.1.23, Part A of the Rules for the Survey and Construction of Steel ships**, hereinafter the same) of the engine is increased to more than 10%.
- (14) “Emission Control Areas” means an area where the adoption of special mandatory measures for emissions from ships is required to prevent, reduce and control air pollution from NO_x or SO_x and particulate matter or all three types of emissions and their attendant adverse impacts on human health and the environment. Emission Control Areas shall include those listed in, or designated under the following **(15)** and **(16)**.
- (15) “NO_x Emission Control Areas” means the following areas:
- (a) The North American Area
 - i) The sea area located off the Pacific coasts of the United States and Canada, enclosed by geodesic lines connecting the coordinates specified in Appendix VII.1 to *Annex VI*.
 - ii) The sea areas located off the Atlantic coasts of the United States, Canada, and France (Saint-Pierre-et-Miquelon) and the Gulf of Mexico coast of the United States enclosed by geodesic lines connecting the coordinates specified in Appendix VII.2 to *Annex VI*.
 - iii) The sea area located off the coasts of the Hawaiian Islands of Hawaii, Maui, Oahu, Molokai, Niihau, Kauai, Lanai, and Kahoolawe, enclosed by geodesic lines connecting the coordinates specified in Appendix VII.3 to *Annex VI*.
 - (b) The United States Caribbean Sea Area

The sea area located off the Atlantic and Caribbean coasts of the Commonwealth of Puerto Rico and the United States Virgin Islands, enclosed by geodesic lines connecting the coordinates specified in Appendix VII.3 to *Annex VI*.
 - (c) The Baltic Sea Area

The Baltic Sea proper with the Gulf of Bothnia, the Gulf of Finland and the entrance to the Baltic Sea bounded by the parallel of the Skaw in the Skagerrak at 57°44.8'N.
 - (d) The North Sea Area

The North Sea proper including seas therein with the boundary between:

- i) the North Sea southwards of latitude 62°N and eastwards of longitude 4°W;
 - ii) the Skagerrak, the southern limit of which is determined east of the Skaw by latitude 57°44.8'N; and
 - iii) the English Channel and its approaches eastwards of longitude 5°W and northwards of latitude 48°30'N.
 - (e) A sea area, including port areas, designated by the *IMO* in accordance with criteria and procedures set forth in Appendix III to *Annex VI* other than those specified in (a) to (d) above.
- (16) “SOx Emission Control Areas” means any sea area, including any port area, designated by the *IMO* in accordance with the criteria and procedures set forth in Appendix III to *Annex VI*. The emission control areas are those areas listed in the following (a) to (d):
- (a) The North American Area
The area specified in (a) of (15) above.
 - (b) The United States Caribbean Sea Area
The area specified in (b) of (15) above.
 - (c) The Baltic Sea Area
The area specified in (c) of (15) above.
 - (d) The North Sea Area
The area specified in (d) of (15) above.
 - (e) The Mediterranean Sea Area
The area including all waters bounded by the coasts of Europe, Africa and Asia, and is described by the following i) to iii) coordinates:
 - i) the western entrance to the Straits of Gibraltar, defined as a line joining the extremities of Cape Trafalgar, Spain (36°11'.00 N, 6°02'.00 W) and Cape Spartel, Morocco (35°48'.00 N, 5°55'.00 W);
 - ii) the Strait of Canakkale, defined as a line joining Mehmetcik Burnu (40°03'N, 26°11'E) and Kumkale Burnu (40°01'.00 N, 26°12'.00 E); and
 - iii) the northern entrance to the Suez Canal excluding the area enclosed by geodesic lines connecting points specified in Appendix VII.4.3 to *Annex VI*.
- (17) “Tanker” means an oil tanker as defined in *Regulation 1* of *Annex I* or a chemical tanker as defined in *Regulation 1* of *Annex II*, and includes any of the following (a) to (c).
- (a) Oil tanker
A ship constructed to carry liquid cargoes in bulk in their cargo spaces (excluding those with cargo spaces which are adapted to exclusively carry cargo other than oil in bulk).
 - (b) Ship carrying noxious liquid substance in bulk
A Ship carrying noxious liquid substance in bulk specified in **2.1.1(7), Part 1**.
 - (c) Combination carrier
A Combination carrier specified in **2.1.1(8), Part 1**.
- (18) “Fuel oil” means any fuel delivered to and intended for combustion purposes for propulsion or operation on board a ship, including gas, distillate and residual fuels.
- (19) “Calendar year” means the period from 1 January until 31 December inclusive.
- (20) “Company” means the owner of the ship or any other organization or person such as the manager, or the bareboat charterer, who has assumed the responsibility for operation of the ship from the owner of the ship and who on assuming such responsibility has agreed to take over all the duties and responsibilities imposed by the *International Management Code for the Safe Operation of Ships and for Pollution Prevention*, as amended.
- (21) “Diesel engine” means any reciprocating internal combustion engine operating on liquid or dual fuel, or that which is gas fuelled subject to **2.1**, including booster/compound systems.
- (22) “Installations” as specified in **1.2.1** means the installation of systems, equipment including portable fire-extinguishing units, insulation, or other material on a ship, but excludes the repair or recharge of previously installed systems, equipment, insulation, or other material, or the recharge of portable fire-extinguishing units.
- (23) “Electronic record book” means a device or system, approved by the Administration, used to electronically record the required entries for discharges, transfers and other operations as required under this Part in lieu of a hard copy record book.

- (24) “Electronic record book of engine parameters” means a device or system, approved by the Administration, used to electronically record the entries required under this Part in lieu of a hard copy record book.
- (25) “Low-flashpoint fuel” means the gaseous or liquid fuel specified in **2.2.1-28, Part GF**.
- (26) “In-use sample” means a sample of fuel oil in use on a ship.
- (27) “Unmanned non-self-propelled (UNSP) barge” means a barge that:
- (a) is not propelled by mechanical means;
 - (b) has no system, equipment and/or machinery fitted that may generate emissions regulated by this Part; and
 - (c) has neither persons nor living animals on board.

1.1.3 Equivalent (Regulation 4 of Annex VI)*

The Society may allow any fitting, material, appliance or apparatus to be installed on board as well as any other procedures, alternative fuel oils, or compliance methods to be used as an alternative to those required by the requirements of the Rules, in cases where such are at least as effective in terms of emission reduction as those required by the Rules.

1.2 General Requirement

1.2.1 Ozone Depleting Substances (Regulation 12 of Annex VI)*

1 The requirements specified in this **1.2.1** apply to all installations excluding permanently sealed equipment which meets the following **(1)** and **(2)** requirements:

- (1) there are no refrigerant charging connections, and
- (2) there are no potentially removable components containing ozone depleting substances.

2 Installations which contain ozone depleting substances are to be arranged so as to prevent emissions of ozone depleting substances, where necessary, in the course of maintaining, servicing, repairing or disposing of systems or equipment.

3 Installations which contain ozone depleting substances, other than hydro-chlorofluorocarbons are prohibited:

- (1) on ships constructed on or after 19 May 2005; or
- (2) on ships constructed before 19 May 2005 in the following cases:
 - (a) the contractual delivery date of the equipment to the ship is on or after 19 May 2005; or,
 - (b) in the absence of a contractual delivery date, the actual delivery of the equipment to the ship is on or after 19 May 2005.

4 Installations which contain hydro-chlorofluorocarbons are prohibited:

- (1) on ships constructed on or after 1 January 2020; or
- (2) on ships constructed before 1 January 2020 in the following cases:
 - (a) the contractual delivery date of the equipment to the ship is on or after 1 January 2020; or,
 - (b) in the absence of a contractual delivery date, the actual delivery of the equipment to the ship is on or after 1 January 2020.

5 Each ship which keeps an International Air Pollution Prevention Certificate issued in accordance with Regulation 6.1 of Annex VI is to maintain a list of equipment containing ozone depleting substances.

6 Each ship, in accordance with **-5** above, which has rechargeable systems that contain ozone depleting substances is to maintain an Ozone Depleting Substances Record Book of which entries are to be recorded in terms of substance mass and to be completed without delay on each occasion, in respect of the following **(1)** through **(5)**. This Record Book may form part of an existing log-book or electronic record book as approved by the Administration.

- (1) Recharge, full or partial, of equipment containing ozone depleting substances.
- (2) Repair or maintenance of equipment containing ozone depleting substances.
- (3) Discharge of ozone depleting substances to the atmosphere:
 - (a) deliberate (includes emissions of ozone depleting substances in the course of maintaining, servicing, repairing or disposing of systems or equipment), and
 - (b) non-deliberate.
- (4) Discharge of ozone depleting substances to land-based reception facilities.
- (5) Supply of ozone depleting substances to the ship.

1.2.2 Use and Carriage of Fuel Oil (*Regulation 14 of Annex VI*)*

- 1 The sulphur content of fuel oil used or carried for use on board a ship is not to exceed 0.50% *m/m*.
- 2 While a ship is operating within an emission control area, the sulphur content of fuel oil used on board that ship is not to exceed 0.10% *m/m*, in addition to the requirements specified in -1 above.
- 3 The sulphur content of fuel oil referred to in -1 and -2 above is to be documented by its supplier as required by Regulation 18 of *Annex VI*.

1.2.3 Delivery of Fuel Oil and Bunker Delivery Notes (*Regulation 18 of Annex VI*)*

1 Except where it may otherwise be accepted in accordance with Regulations 18.2.1 to 18.2.5 of *Annex VI*, fuel oil for combustion purposes delivered to and used on board ships is to meet the following (1) and (2) requirements:

- (1) Except as provided in (2) below, the following (a) to (c) requirements are to be satisfied.
 - (a) The fuel oil is to be blends of hydrocarbons derived from petroleum refining. This is not to preclude the incorporation of small amounts of additives intended to improve some aspects of performance.
 - (b) The fuel oil is to be free from inorganic acid.
 - (c) The fuel oil is not to include any added substance or chemical waste which:
 - i) jeopardizes the safety of ships or adversely affects the performance of the machinery,
 - ii) is harmful to personnel, or
 - iii) contributes overall to additional air pollution.
- (2) The fuel oil derived by methods other than petroleum refining is not:
 - (a) to exceed the applicable sulphur content specified in -1 or -2 of 1.2.2,
 - (b) to cause the NO_x emission from a diesel engine to exceed the limits specified in 2.1.2-1,
 - (c) to contain inorganic acid,
 - (d) to jeopardize the safety of ships or adversely affect the performance of the machinery,
 - (e) to be harmful to personnel, or
 - (f) to contribute overall to additional air pollution.

2 For each ship deemed necessary by the Society, including mobile offshore drilling unit and other platform, details of fuel oil for combustion purposes delivered to and used on board is to be recorded by means of a bunker delivery note. The bunker delivery note is to be retained on board the ship for a period of 3 *years* after the fuel oil has been delivered on board. The bunker delivery note is to be kept on board the ship in such a place as to be readily available for inspection at all reasonable times.

3 The bunker delivery note referred to -2 above is to contain at least the information specified in Appendix V to *Annex VI*.

4 The bunker delivery note referred to in -3 is to be accompanied by a representative sample of the fuel oil delivered obtained in a way deemed appropriate by the Society. The sample is to be sealed and signed by the supplier's representative and the master or officer in charge of the bunker operation on completion of bunkering operations and retained on board the ship in a way deemed appropriate by the Society until the fuel oil is substantially consumed, but in any case for a period of not less than 12 *months* from the time of delivery.

5 The requirements specified in -1 to -4 above do not apply to coal in its solid form or nuclear fuels. The requirements specified in -2 to -4 above do not apply to gas fuels such as liquefied natural gas, compressed natural gas or liquefied petroleum gas. The sulphur content of gas fuels delivered to a ship specifically for combustion purposes on board that ship is to be documented by the supplier.

1.2.4 Substances Prohibited to Be Incinerated On Board (*Regulation 16 of Annex VI*)

Substances prohibited to be incinerated on board ships are those listed below.

- (1) Residue of the cargoes listed in the following (a) through (c) and related contaminated packing materials.
 - (a) Oil
 - (b) Noxious liquid substance
 - (c) Marine pollutant
- (2) Polychlorinated biphenyls (PCBs).
- (3) Garbage containing heavy metals. (The term "garbage" means all kinds of victual, domestic and operational waste excluding fresh fish and parts thereof, generated during the normal operation of the ship and liable to be disposed of continuously or periodically.)
- (4) Refined petroleum products containing halogen compounds.

- (5) Polyvinyl chlorides (PVCs) (except when incinerated in an incinerator complying with the requirements in [2.4-1\(2\)](#) or the equivalent).
- (6) Sewage sludge and sludge oil which are not generated by the ship.
- (7) Exhaust gas cleaning system residues.

Chapter 2 EQUIPMENT FOR THE PREVENTION OF AIR POLLUTION FROM SHIPS

2.1 Nitrogen Oxides (NOx) (Regulation 13 of Annex VI)

2.1.1 General*

1 The requirements specified in this 2.1 apply to each diesel engine operating on liquid or dual fuel and each gas fuelled engine on board ships with a power output of more than 130kW in the case of any of the following (1) to (4):

- (1) Engines, excluding gas fuelled engines, which are installed on ships at beginning stage of construction on or after 1 January 2000;
- (2) Engines, excluding gas fuelled engines, which undergo a major conversion on or after 1 January 2000;
- (3) Gas fuelled engines which are installed on ships at beginning stage of construction on or after 1 March 2016; or
- (4) Gas fuelled additional or non-identical replacement engines which are installed on or after 1 March 2016.

2 Notwithstanding -1, the requirements specified in this 2.1 need not apply to diesel engines listed below.

- (1) Engines intended for emergency services and engines installed in lifeboats and any device or equipment intended to be used solely in case of emergency.
- (2) Engines installed on ships solely engaged in voyages within waters deemed appropriate by the Society provided that such engines are subject to an alternative NOx control measure deemed appropriate by the Society.
- (3) Engines, except those which undergoes a major conversion on or after 19 May 2005, installed on a ship which had been at beginning stage of construction before 19 May 2005 and not engaged in the international voyage, when deemed appropriate by the Society.

3 Notwithstanding the requirements of -1(1) above, a diesel engine with a power output of more than 5,000kW and a per cylinder displacement at or above 90 litres installed on a ship at beginning stage of construction on or after 1 January 1990 but prior to 1 January 2000 is to comply with the maximum allowable NOx emission limits specified in Table 8-1(a), provided that the Approved Method for such engine has been submitted to the IMO by the certifying Administration.

4 Diesel engines subject to 2.1 are to have an EIAPP certificate issued in accordance with the Rules for Marine Engine Emission Verification and a Technical File approved in accordance with the Rules for Marine Engine Emission Verification. Other documentation, however, may be also accepted in cases where deemed to be equivalent thereto.

5 In cases where diesel engines, for which the EIAPP certificate is first issued on or after 1 June 2019, are equipped with an exhaust gas recirculation system having a bleed-off water discharge arrangement, said arrangement is to comply with a standard deemed appropriate by the Society.

2.1.2 Requirements for Installation*

1 On each diesel engine, the exhaust gas cleaning system to reduce NOx emissions specified in the approved Technical File is to be installed, otherwise the equivalent method to reduce NOx emissions deemed appropriate by the Society is to be carried out in order to keep the NOx emission measured and calculated in accordance with the following -2 within the limits specified in Tables 8-1(a) to (c) at the number of maximum continuous revolutions (referred to in 2.1.24, Part A of the Rules for the Survey and Construction of Steel ships, hereinafter the same) of the diesel engine.

- (1) Diesel engines which are installed on ships at beginning stage of construction on or after 1 January 2000

- (a) Tier I

For ships at beginning stage of construction on or after 1 January 2000 and prior to 1 January 2011 installed with diesel engines

- (b) Tier II

For ships at beginning stage of construction on or after 1 January 2011 installed with diesel engines

- (c) Tier III

For either of the following ships which operate in applicable NOx emission control areas installed with diesel engines:

- i) Ships at beginning stage of construction on or after 1 January 2016 which operate in the NOx emission control areas

- specified in (a) and (b) of 1.1.2(15);
- ii) Ships at beginning stage of construction on or after 1 January 2021 which operate in the NOx emission control areas specified in (c) and (d) of 1.1.2(15); or
 - iii) Ships at beginning stage of construction on or after the date of the adoption of such a NOx emission control area by the *IMO* or a later date as may be specified by the *IMO* in accordance with Regulation 13.5.1.3 of Annex VI, whichever is later which operate in NOx emission control areas other than those specified in (a) to (d) of 1.1.2(15).
- (d) The requirements specified in (c) above do not apply to the following ships:
- i) Ships with a length of less than 24 m that have been specifically designed, and are used solely for recreational purposes; or
 - ii) Ships with a combined nameplate diesel engine propulsion power of less than 750 kW if it can be demonstrated, to the satisfaction of the Administration, that the ship cannot comply with the standards specified in Table 8-1(c) because of design or construction limitations; or
 - iii) Ships of less than 500 gross tonnage with a length of 24 m or over at beginning stage of construction on or after 1 January 2021 specifically designed, and used solely, for recreational purposes.
- (2) Major conversions of diesel engines performed on or after 1 January 2000

When replacing a diesel engine with a non-identical diesel engine or when installing an additional diesel engine, the standards in force at the time of the replacement or addition of the diesel engine are to be applied. However, for engine replacements, if the Administration deems it impossible for such a replacement diesel engine to meet the standards set forth in Table 8-1(c), then that replacement diesel engine is to meet the standards set forth in Table 8-1(b). The criteria for determining when it is not possible for a replacement engine to meet the standards in Table 8-1(c) are to be in accordance with relevant guidelines established by the *IMO*.

Table 8-1(a) Maximum Allowable NOx Emission Limits (Tier I)

Number of maximum continuous revolutions N_0 (rpm)	Maximum allowable NOx emission limits (g/kWh)
$N_0 < 130$	17.0
$130 \leq N_0 < 2000$	$45.0 \times N_0^{(-0.2)}$
$2000 \leq N_0$	9.8

Table 8-1(b) Maximum Allowable NOx Emission Limits (Tier II)

Number of maximum continuous revolutions N_0 (rpm)	Maximum allowable NOx emission limits (g/kWh)
$N_0 < 130$	14.4
$130 \leq N_0 < 2000$	$44.0 \times N_0^{(-0.23)}$
$2000 \leq N_0$	7.7

Table 8-1(c) Maximum Allowable NOx Emission Limits (Tier III)

Number of maximum continuous revolutions N_0 (rpm)	Maximum allowable NOx emission limits (g/kWh)
$N_0 < 130$	3.4
$130 \leq N_0 < 2000$	$9.0 \times N_0^{(-0.2)}$
$2000 \leq N_0$	2.0

2 Measurement and calculation is to be in accordance with the following:

- (1) NOx emissions are to be measured and calculated applying a test cycle in accordance with the following (a) to (e).
 - (a) For constant-speed diesel engines for ship main propulsion, including diesel-electric drive, test cycle E2 specified in **Table 8-2** is to be applied.
 - (b) For controllable-pitch propeller sets test cycle E2 specified in **Table 8-2** is to be applied.
 - (c) For propeller-law-operated main and propeller-law-operated auxiliary diesel engines test cycle E3 specified in **Table 8-3** is to be applied.
 - (d) For constant-speed auxiliary diesel engines, the test cycle D2 specified in **Table 8-4** is to be applied.
 - (e) For variable-speed, variable-load auxiliary diesel engines, not included in (a) to (d) above, the test cycle C1 specified in **Table 8-5** is to be applied.
- (2) NOx emission is to be verified using one of the followings in accordance with the procedures specified otherwise by the Society.
 - (a) Measurement procedures for emission verification on a test bed
 - (b) On-board simplified measurement method
 - (c) On-board direct measurement and monitoring method
- (3) The measurement is to be carried out using the fuel specified otherwise by the Society.
- (4) NOx emission value and the limit, rounded to one decimal place, are to be obtained.

Table 8-2 Test Cycle Type E2

Number of revolutions	100%	100%	100%	100% ^{*(2)}
Output	100%	75%	50%	25%
Weighting factor ^{*(1)}	0.2	0.5	0.15	0.15

Table 8-3 Test Cycle Type E3

Number of revolutions	100%	91%	80%	63%
Output	100%	75%	50%	25%
Weighting factor ^{*(1)}	0.2	0.5	0.15	0.15

Table 8-4 Test Cycle Type D2

Number of revolutions	100%	100%	100%	100%	100%
Output	100%	75%	50%	25%	10%
Weighting factor ^{*(1)}	0.05	0.25	0.3	0.3	0.1

Table 8-5 Test Cycle Type C1

Number of revolutions	Number of maximum continuous revolutions				Intermediate ^{*(4)}			Idle
	100%	75%	50%	10%	100%	75%	50%	
Torque ^{*(3)}	100%	75%	50%	10%	100%	75%	50%	0%
Weighting factor ^{*(1)}	0.15	0.15	0.15	0.1	0.1	0.1	0.1	0.15

Notes:

*⁽¹⁾ Those specified in 5.12.6 of the *NOx Technical Code*.

*⁽²⁾ There are exceptional cases, including large bore diesel engines intended for E2 applications, in which, due to their oscillating masses and construction, diesel engines cannot be run at low load at nominal speed without the risk of damaging essential components. In such cases, the diesel engine manufacturer is to make application to the Administration that the test cycle as given in **Table 8-2** may be modified for the 25% power mode with regard to the diesel engine speed. The adjusted diesel engine speed at 25% power, however, is to be as close as possible to the rated diesel engine speed, as recommended by the diesel engine manufacturer and approved by the Administration. The applicable weighting factors for the

test cycle are to remain unchanged.

- * (3) The ratio of the required torque to the maximum possible torque at the given number of revolutions.
- * (4) To be declared by the diesel engine manufacturer, etc., taking into account the following requirements:
 - (a) For diesel engines which are designed to operate over a speed range on a full load torque curve:
 - i) If the maximum torque is obtained at the number of revolutions less than 60% of the number of maximum continuous revolutions, it is to be 60% of the number of maximum continuous revolutions.
 - ii) If the maximum torque is obtained at the number of revolutions between 60% and 75% of the number of maximum continuous revolutions, it is to be that number of revolutions.
 - iii) If the maximum torque is obtained at the number of revolutions greater than 75% of the number of maximum continuous revolutions, it is to be 75% of the number of maximum continuous revolutions.
 - (b) For diesel engines other than those referred to in (a) above, it is typically to be between 60% and 70% of the number of maximum continuous revolutions.

3 Where an additional substance is introduced, such as ammonia, urea, steam, water, fuel additives, etc., a means of monitoring the consumption of such substance is to be provided.

4 When a new test cycle is applied to a diesel engine already verified using a different test cycle listed in (a) to (e) of -2(1) above, the verification may be carried out by recalculation, by applying the measurement results from the specific modes of the first verification to the calculation of the total weighted emissions for the new test cycle application, using the corresponding weighting factors from the new test cycle.

2.1.3 Technical File and Record Book of Engine Parameters*

1 Technical File

Every diesel engine is to be accompanied with an approved Technical File prepared by the diesel engine manufacturer, etc. and containing the following information.

- (1) Identification of those components, including detailed information to enable to find out whether they are modified or not, settings and operating values of the diesel engine which influence its NO_x emissions including any NO_x-reducing device or system.
- (2) Identification of the full range of allowable adjustments or alternatives for the components of the diesel engine.
- (3) Full record of the relevant diesel engine's performance, including the number of maximum continuous revolutions and maximum continuous output of the diesel engine consistent with those specified on the nameplate.
- (4) At least one of the methods to verify NO_x emissions, which is listed in 2.1.2-2(2) and applicable at the inspection specified in 3.2.2-4(2), Part 2, or the on-board diesel engine parameter check method otherwise specified by the Society. When on-board direct measurement and monitoring method is applied, procedures for calibration and operation of the measuring equipment specified by the diesel engine manufacturer, etc. are to be contained. In addition, when exhaust gas cleaning system to reduce NO_x emissions is installed, on-board NO_x verification procedures for the system to ensure it is operating correctly are also to be contained.
- (5) A copy of the test report on the testing in accordance with Section 2, Annex V of the *NO_x Technical Code*. (In the case where the on-board simplified measurement method applied in accordance with 2.2.5.2 of the *NO_x Technical Code* was conducted for emission verification, both the test reports are to be included.) For a Member Engine of an Engine Family or Engine Group, it may be substituted for that for the Parent Engine.
- (6) If applicable, the designation and restrictions for a diesel engine which is a member of an Engine Family or Engine Group in consistent with the requirement specified in Chapter 4 of the *NO_x Technical Code*.
- (7) Specifications of those spare parts/components of the diesel engine which, when used in the diesel engine, according to those

specifications, will result in continued compliance of the NOx emission with the limits specified in **2.1.2-1**.

- (8) *EIAPP Certificate*, where it has been issued.
- (9) In case the exhaust gas cleaning system to reduce NOx emissions is installed, record of the presence of the system as a component of the diesel engine.
- (10) Where an additional substance is introduced, such as ammonia, urea, steam, water, fuel additives, etc., a ready means of demonstrating that the consumption of such additional substances is consistent with achieving compliance with the applicable NOx limit.
- (11) Other information considered necessary by the Society.

2 Record Book of Engine Parameters

Each diesel engine is to be accompanied with a record book or electronic record book of engine parameters in which a full record of adjustments, modifications and all parameter changes, including components and settings of the diesel engine which may influence NOx emission made after the approval of Technical File, are contained.

2.1.4 Recording of Information related to NOx Emission Control

The tier (Tier II or Tier III) and on/off status of diesel engines installed on board a ship to which **2.1.2-1(1)(c)** applies which are certified to both Tier II and Tier III or which are certified to Tier II only is to be recorded in such log-book or electronic record book as prescribed by the Administration together with the date, time and position of the ship on the following occasions:

- (1) at entry into an applicable NOx emission control area;
- (2) at exit from an applicable NOx emission control area; or
- (3) when the on/off status changes within an applicable NOx emission control area.

2.2 Sulphur Oxides (SOx) and Particulate Matter (Regulation 14 of Annex VI)

2.2.1 Fuel Oil Change-over on Ship Operating in SOx Emission Control Areas

1 Those ships using separate fuel oils to comply with **1.2.2-2** and entering or leaving a SOx Emission Control Area are to carry a written procedure showing how the fuel oil change-over is to be done, allowing sufficient time for the fuel oil service system to be fully flushed of all fuel oils exceeding the applicable sulphur content specified in **1.2.2-2** prior to entry into such an Emission Control Area. The volume of low sulphur fuel oils (complying with **1.2.2-2**) in each tank as well as the date, time, and position of the ship on the following **(1)** and **(2)** occasions is to be recorded in such log-book or electronic record book as prescribed by the Administration.

- (1) When any fuel-changeover operation is completed prior to entry into a SOx Emission Control Area, to flush all fuels used out of the area and to start using fuel oils complying with **1.2.2-2**.
- (2) When fuel-changeover operation is commenced after exit from such a SOx Emission Control Area, to start using fuels to be used out of the area.

2 During the first 12 months immediately following a designation of a specific SOx Emission Control Area, the requirements in this **2.2.1** do not apply to the fuel oils used in the area.

2.2.2 In-use fuel oil sampling points*

1 For ships (including mobile offshore drilling units and other platforms) of 400 *gross tonnage* and above engaged in international voyages that are at the beginning stage of their construction on or after 1 April 2022, sampling points are to be fitted or designated for the purpose of taking representative samples (in-use samples) of the fuel oil being used on board the ship, taking into account guidelines deemed appropriate by the Society.

2 For ships (including mobile offshore drilling units and other platforms) of 400 *gross tonnage* and above engaged in international voyages that are at the beginning stage of their construction before 1 April 2022, the sampling points specified in **-1** above are to be fitted or designated no later than the first Special Survey carried out on or after 1 April 2023.

3 The requirements specified in **-1** and **-2** above are not applicable to fuel oil service systems for low-flashpoint fuels for combustion purposes for propulsion or operation on board the ship.

2.3 Vapour Collection System (Regulation 15 of Annex VI)*

1 For ships listed in **(1)** and **(2)** which load in ports or terminals where emissions of volatile organic compounds are regulated

by the administration, a vapour collection system otherwise specified by the Society is to be installed on board.

- (1) Tankers
- (2) Ships carrying liquefied gases in bulk (when the type of loading and containment systems allow safe retention of non-methane volatile organic compounds on board, or their safe return ashore)

2 For every ship to which the vapour collection system referred to in **-1** is installed, a manual relates to its operation including those information listed below is to be provided.

- (1) A line diagram of piping of the system
- (2) The maximum allowable transfer rate
- (3) The maximum pressure drop in the system for various transfer rate
- (4) The relief settings of each pressure and vacuum relief valve
- (5) Operational procedures of the system
- (6) Procedures to be followed other than those listed in **(1)** through **(5)**

3 Tankers carrying crude oil are to have on board and implement a VOC Management Plan approved by the Administration. The plan is to be specific to each ship and to comply with the following:

- (1) To provide written procedures for minimizing VOC emissions during the loading, sea passage, and discharge of cargo
- (2) To give consideration to any additional VOC generated by crude oil washing
- (3) To identify a person responsible for implementing the plan
- (4) For ships on international voyages, to be written in the working language of the master and officers and, if the working language of the master and officers is not English, French, or Spanish, include a translation into one of these languages.

2.4 Incinerator (*Regulation 16 of Annex VI*)*

1 For each ship on which wastes or other matter generated during the normal operation of the ship are incinerated, an incinerator complying with the following requirements is to be installed on board. However, incineration of sewage sludge or sludge oil (sludge from the fuel or lubricating oil purifiers, waste lubricating oil from main or auxiliary machinery, or waste oil from oily-water separating equipment, oil filtering system or drip trays) may take place in diesel engines or boilers outside ports, harbours and estuaries.

- (1) Incinerators are to be designed for the primary purpose of incineration of the wastes, etc.
- (2) Each incinerator installed on board a ship on or after 1 January 2000 is to comply with the following requirements. However, incinerators installed on board a ship before 19 May 2005 are exempted from the requirements in this **(2)** provided that the ship is solely engaged in voyages within waters deemed appropriate by the Society.
 - (a) It is to have a construction deemed appropriate by the Society and, when the standard fuel/waste specified in **Table 8-6** is used, to be operated within the limits specified in **Table 8-7**.
 - (b) It is to be capable of monitoring of combustion flue gas outlet temperature at all times.
 - (c) In case waste is fed into the combustion chamber without human assistance while the incinerator is in normal operating conditions, waste is not to be fed into the unit when the combustion chamber gas outlet temperature is below 850°C.
 - (d) For batch-loaded incinerators, the unit is to be designed so that the combustion chamber gas outlet temperature is to reach 600°C within 5 minutes after start-up and is to thereafter stabilize at a temperature not less than 850°C.

2 All ships with incinerators complying with the requirements in **-1(2)** are to be provided with operating manuals for the incinerators prepared by the manufacturer which specify how to operate the incinerator within the limits described in **Table 8-7** and include the following information.

- (1) Drawings
- (2) Electric diagrams
- (3) Instruction and maintenance manual

3 Every incinerator is to be operated by a trained personnel in accordance with an operating manual (in case an operating manual is required in **-2**, that manual) prepared by the manufacturer.

Table 8-6 Standard Fuel/Waste

Fuel/Waste	Component
Sludge Oil	Sludge Oil from Heavy Fuel Oil 75%
	Waste Lubricating Oil 5%
	Emulsified Water 20%
Solid Waste (The mixture will have up to 50% moisture and 7% incombustible solids.)	Food Waste 50%
	Rubbish 50%
	Breakdown: Paper Approx. 15%
	Cardboard Approx. 20%
	Rags Approx. 5%
	Plastic Approx. 10%

Table 8-7 Limits for Operation of Incinerators

Items	Limits
O ₂ in Combustion Chamber	6 - 12 %
CO in Flue Gas Maximum Average	200mg/MJ
Soot Number Maximum Average	BACHARACH 3 or RINGELMAN 1 (20% opacity) (A higher soot number is acceptable only during very short periods such as starting up)
Unburned Components in Ash Residues	Maximum 10% by Mass
Combustion Chamber Flue Gas Outlet Temperature Range	850 - 1,200°C

Chapter 3 ENERGY EFFICIENCY FOR SHIPS

3.1 General

3.1.1 Goal (Regulation 20 of Annex VI)

The goal of this chapter is to reduce the carbon intensity of international shipping, working towards the “levels of ambition” set out in the Initial *IMO* Strategy on reduction of GHG emissions from ships”.

3.1.2 Functional requirements (Regulation 21 of Annex VI)

In order to achieve **3.1.1 above**, ships subject to this chapter are to comply, as applicable, with the following functional requirements (1) and (2) to reduce their carbon intensities:

- (1) The technical carbon intensity requirements specified in **3.2** to **3.5**.
- (2) The operational carbon intensity requirements specified in **3.6** to **3.9**.

3.1.3 Application (Regulation 19 of Annex VI)*

1 The requirements in this Chapter apply to all ships of 400 *gross tonnage* and above other than those solely engaged in voyages within waters subject to the sovereignty or jurisdiction of the State the flag of which the ship is entitled to fly. However, they do not apply to ships not propelled by mechanical means, and platforms including FPSOs, FSUs and drilling rigs, regardless of their propulsion.

2 Notwithstanding **-1, 3.2, 3.3, 3.4** and **3.5** do not to apply to ships which have non-conventional propulsion, except the following (1) and (2).

- (1) Requirements **3.2** and **3.4** apply to cruise passenger ships having non-conventional propulsion and LNG carriers having conventional or non-conventional propulsion delivered on or after 1 September 2019.
- (2) Requirements **3.3** and **3.5** apply to cruise passenger ships having non-conventional propulsion and LNG carriers having conventional or non-conventional propulsion.

3 Notwithstanding **-1** above, **3.2, 3.3, 3.4, 3.5** and **3.9** do not to apply to category *A* ships as defined in the Polar Code.

4 Notwithstanding **-1** above, **3.2** and **3.4** need not be applied to ships of 400 *gross tonnage* and above which are exempted by the Administration from complying with the requirements except in the following cases:

- (1) Ships for which the building contract is placed on or after 1 January 2017
- (2) In the absence of a building contract, ships at the beginning stage of construction on or after 1 July 2017
- (3) Ship for which the delivery is on or after 1 July 2019
- (4) New ships or existing ships in which a major conversion is carried out on or after 1 January 2017.

5 Notwithstanding **-1** to **-4**, the requirements in this Chapter need not be applied in cases where deemed appropriate by the Society.

3.1.4 Terminology (Regulation 2.2 of Annex VI)*

For the purpose of this Chapter, the following definitions apply:

- (1) “A ship delivered on or after 1 September 2019” means as follows:
 - (a) ships for which the building contract is placed on or after 1 September 2015;
 - (b) in the absence of a building contract, ships at the beginning stage of construction on or after 1 March 2016; or
 - (c) ships for which the delivery is on or after 1 September 2019.
- (2) “Attained annual operational CII” is the operational carbon intensity indicator value achieved by an individual ship in accordance with **3.6** and **3.9**.
- (3) “Attained EEDI” is the EEDI value achieved by an individual ship in accordance with **3.2**.
- (4) “Attained EEXI” is the EEXI value achieved by an individual ship in accordance with **3.3**.
- (5) “Bulk carrier” means a ship which is intended primarily to carry dry cargo in bulk, including such types as ore carriers, but excluding combination carriers.
- (6) “Calendar year” means the period from 1 January until 31 December inclusive.
- (7) “Combination carrier” means a ship designed to load 100 % deadweight with both liquid and dry cargo in bulk.
- (8) “Company” means the owner of the ship or any other organization or person such as the manager, or the bareboat charterer, who has assumed the responsibility for operation of the ship from the owner of the ship and who on assuming such responsibility

has agreed to take over all the duties and responsibilities imposed by the *International Management Code for the Safe Operation of Ships and for Pollution Prevention* as amended.

- (9) “Containership” means a ship designed exclusively for the carriage of containers in holds and on deck.
- (10) “Conventional propulsion” means a method of propulsion where a main reciprocating internal combustion engine is the prime mover and coupled to a propulsion shaft either directly or through a gear box.
- (11) “Cruise passenger ship” means a passenger ship not having a cargo deck, designed exclusively for commercial transportation of passengers in overnight accommodations on a sea voyage.
- (12) “Existing ship” means a ship which is not a new ship.
- (13) “Gas carrier” means a cargo ship constructed or adapted and used for the carriage in bulk of any liquefied gas but does not include LNG carrier specified in (17).
- (14) “General cargo ship” means a ship with a multi-deck or single deck hull designed primarily for the carriage of general cargo. This definition excludes specialized dry cargo ships (e.g. livestock carriers, barge carriers, heavy load carriers, yacht carriers and nuclear fuel carriers) not included in the calculation of reference lines for general cargo ships.
- (15) “LNG carrier” means a cargo ship constructed or adapted and used for the carriage in bulk of liquefied natural gas (LNG).
- (16) “Major conversion” means any of the following.
 - (a) A conversion that substantially alters the dimensions, carrying capacity or engine power of the ship.
 - (b) A conversion that changes the type of the ship.
 - (c) A conversion whose intent in the opinion of the Administration is to substantially prolong the life of the ship.
 - (d) A conversion which otherwise so alters the ship that, if it were a newly constructed ship, it would become subject to relevant provisions of the present convention not applicable to it as an existing ship.
 - (e) A conversion which substantially alters the energy efficiency of the ship and includes any modifications that could cause the ship to exceed the applicable required EEDI specified in 3.4 and required EEXI specified in 3.5.
- (17) “New ship” means as follows:
 - (a) ships for which the building contract is placed on or after 1 January 2013;
 - (b) in the absence of a building contract, ships at the beginning stage of construction on or after 1 July 2013; or
 - (c) ships for which the delivery is on or after 1 July 2015.
- (18) “Non-conventional propulsion” means a method of propulsion, other than conventional propulsion, including diesel-electric propulsion, turbine propulsion, and hybrid propulsion systems.
- (19) “Passenger ship” means a ship which carries more than 12 passengers.
- (20) “Polar Code” means the International Code for Ships Operating in Polar Waters, consisting of an introduction, Parts I-A and II-A and Parts I-B and II-B, adopted by resolutions MSC.385(94) and MEPC.264(68), as may be amended, provided that the following conditions are satisfied:
 - (a) amendments to the environment-related provisions of the introduction and Chapter 1 of Part II-A of the Polar Code are adopted, brought into force and take effect in accordance with the provisions of Article 16 of the present convention concerning the amendment procedures applicable to an appendix to an annex; and
 - (b) amendments to Part II-B of the Polar Code are adopted by the Marine Environment Protection Committee in accordance with its “Rules of Procedure”.
- (21) “Refrigerated cargo carrier” means a ship designed exclusively for the carriage of refrigerated cargoes in holds.
- (22) “Required annual operational CII” is the target value of attained annual operational CII in accordance with 3.6 and 3.9 for the specific ship type and size.
- (23) “Required EEDI” is the maximum value of attained EEDI that is allowed by 3.4 for the specific ship type and size.
- (24) “Required EEXI” is the maximum value of attained EEXI that is allowed by 3.5 for the specific ship type and size.
- (25) “Ro-ro cargo ship” means a ship designed for the carriage of roll-on-roll-off cargo transportation units.
- (26) “Ro-ro cargo ship (vehicle carrier)” means a multi deck roll-on-roll-off cargo ship designed for the carriage of empty cars and trucks.
- (27) “Ro-ro passenger ship” means a passenger ship with roll-on-roll-off cargo spaces.
- (28) “Tanker” means an oil tanker as defined in 2.1.1(6), Part 1, an NLS tanker as defined in 2.1.1(7), Part 1, or a chemical tanker as defined in 1.3.1(9), Part S of Rules for the Survey and Construction of Steel Ships.

3.2 Attained Energy Efficiency Design Index (Attained EEDI) (Regulation 22 of Annex VI)*

1 The attained EEDI is to be calculated for the following and is to be verified in accordance with guidelines deemed appropriate by the Society, based on the EEDI Technical File, either by the Society or the Administration.

- (1) New ships that fall into one or more of the categories in **3.1.4(5)**, (7), (9), (11), (13) to (15), (19), (21) and (25) to (28).
- (2) New ships that have undergone a major conversion and that fall into one or more of the categories in **3.1.4(5)**, (7), (9), (11), (13) to (15), (19), (21) and (25) to (28).
- (3) New ships or existing ships that have undergone a major conversion (i.e. the conversion is so extensive that the ship is regarded as newly constructed by the Administration) and that fall into one or more of the categories in **3.1.4(5)**, (7), (9), (11), (13) to (15), (19), (21) and (25) to (28).

2 The attained EEDI is to be specific to each ship and is to indicate the estimated performance of the ship in terms of energy efficiency; moreover, it is to be accompanied by the EEDI Technical File that contains the information necessary for the calculation of the attained EEDI and shows the process of calculation.

3 The attained EEDI is to be calculated in accordance with guidelines deemed appropriate by the Society.

3.3 Attained Energy Efficiency Existing Ship Index (Attained EEXI) (Regulation 23 of Annex VI)

1 The attained EEXI is to be calculated for the following and is to be verified in accordance with guidelines deemed appropriate by the Society (based on the EEXI Technical File) either by the Society or the Administration.

- (1) Ships that fall into one or more of the categories in **3.1.4(5)**, (7), (9), (11), (13) to (15), (21) and (25) to (28).
- (2) Ships that have undergone a major conversion and that fall into one or more of the categories in **3.1.4(5)**, (7), (9), (11), (13) to (15), (21) and (25) to (28).

2 The attained EEXI is to be specific to each ship and is to indicate the estimated performance of the ship in terms of energy efficiency; moreover, it is to be accompanied by an EEXI Technical File that contains the information necessary for the calculation of the attained EEXI and shows the process of calculation.

3 The attained EEXI is to be calculated in accordance with guidelines deemed appropriate by the Society.

4 In cases where the attained EEXI verified by the Administration or the Society is more than the required EEXI specified in **3.5**, and the ship is provided with a Shaft/Engine Power Limitation (SHaPoLi/EPL) system deemed appropriate by the Society to satisfy **3.5**, an Onboard Management Manual (OMM) for SHaPoLi/EPL is to be created in accordance with guidelines deemed appropriate by the Society and is to be verified by the Administration or the Society.

5 Notwithstanding -1 and -2 above, for ships to which **3.2** applies, the attained EEDI verified by the Administration or the Society in accordance with **3.2-1** and **-2** may be taken as the attained EEXI if the value of the attained EEDI is equal to or less than that of the EEXI required by **3.5**. In this case, the attained EEXI is to be verified based on the EEDI technical file.

3.4 Required Energy Efficiency Design Index (Required EEDI) (Regulation 24 of Annex VI)*

1 The attained EEDI of the following (1) to (3) is not to exceed the required EEDI calculated according to the equation specified below:

- (1) New ships that fall into or more of the categories in **3.1.4(5)**, (7), (9), (11), (13) to (15), (21) and (25) to (28).
- (2) New ships that have undergone a major conversion which fall into one or more of the categories in **3.1.4(5)**, (7), (9), (11), (13) to (15), (21) and (25) to (28).
- (3) New ships or existing ships that have undergone a major conversion (i.e. a conversion so extensive that the ship is regarded as newly constructed by the Administration) that fall into one or more of the categories in **3.1.4(5)**, (7), (9), (11), (13) to (15), (21) and (25) to (28).

$$\text{Attained EEDI} \leq \text{Required EEDI} = (1-X/100) \times \text{reference line value}$$

where,

X: reduction factor specified in **Table 8-8** for the required EEDI compared to the EEDI reference line.

Reference line value: $a \times b^{-c}$

a, b and c: parameters given in [Table 8-9](#)

2 For each new and existing ship that has undergone a major conversion which is so extensive that the ship is regarded as newly constructed by the Administration, the attained EEDI is to be calculated and satisfy the requirements of -1 with the reduction factor applicable corresponding to type and size of the converted ship at the date of the contract of the conversion, or the commencement date of the conversion in the absence of a contract.

3 If the design of a ship allows it to fall into more than one of the above ship type definitions, the required EEDI for the ship is to be the most stringent (i.e., the lowest) required EEDI.

4 For each ship to which 3.3 applies, the installed propulsion power is not to be less than the propulsion power needed to maintain ship manoeuvrability under adverse conditions as defined in guidelines deemed appropriate by the Society.

Table 8-8 Reduction Factors (In Percentage) for EEDI Relative to the EEDI Reference Line

Ship Type	Size	Reduction Factors (%)					
		Phase 0	Phase 1	Phase 2		Phase 3	
		1 Jan. 2013-31 Dec. 2014	1 Jan. 2015-31 Dec. 2019	1 Jan. 2020-31 Mar. 2022	1 Jan. 2020-31 Dec. 2024	1 Apr. 2022 and onwards	1 Jan. 2025 and onwards
Bulk Carrier	20,000 DWT -	0	10		20		30
	10,000 - 20,000 DWT	n/a	0-10 ⁽¹⁾		0-20 ⁽¹⁾		0-30 ⁽¹⁾
Gas Carrier	15,000 DWT -	0	10	20		30	
	10,000 - 15,000 DWT	0	10		20		30
	2,000 - 10,000 DWT	n/a	0-10 ⁽¹⁾		0-20 ⁽¹⁾		0-30 ⁽¹⁾
Tanker	20,000 DWT -	0	10		20		30
	4,000 - 20,000 DWT	n/a	0-10 ⁽¹⁾		0-20 ⁽¹⁾		0-30 ⁽¹⁾
Container Ship	200,000 DWT -	0	10	20		50	
	120,000 - 200,000 DWT	0	10	20		45	
	80,000 - 120,000 DWT	0	10	20		40	
	40,000 - 80,000 DWT	0	10	20		35	
	15,000 - 40,000	0	10	20		30	

	DWT						
	10,000 - 15,000 DWT	n/a	0-10 ⁽¹⁾	0-20 ⁽¹⁾		15-30 ⁽¹⁾	
General Cargo Ships	15,000 DWT -	0	10	15		30	
	3,000 - 15,000 DWT	n/a	0-10 ⁽¹⁾	0-15 ⁽¹⁾		0-30 ⁽¹⁾	
Refrigerated Carrier	5,000 DWT -	0	10		15		30
	3,000 - 5,000 DWT	n/a	0-10 ⁽¹⁾		0-15 ⁽¹⁾		0-30 ⁽¹⁾
Combination Carrier	20,000 DWT -	0	10		20		30
	4,000 - 20,000 DWT	n/a	0-10 ⁽¹⁾		0-20 ⁽¹⁾		0-30 ⁽¹⁾
LNG carrier ⁽³⁾	10,000 DWT -	n/a	10 ⁽²⁾	20		30	
Ro-ro cargo ship (vehicle carrier) ⁽³⁾	10,000 DWT -	n/a	5 ⁽²⁾		15		30
Ro-ro cargo ship ⁽³⁾	2,000 DWT -	n/a	5 ⁽²⁾		20		30
	1,000 - 2,000 DWT	n/a	0-5 ⁽¹⁾⁽²⁾		0-20 ⁽¹⁾		0-30 ⁽¹⁾
Ro-ro passenger ship ⁽³⁾	1000 DWT-	n/a	5 ⁽²⁾		20		30
	250 - 1,000 DWT	n/a	0-5 ⁽¹⁾⁽²⁾		0-20 ⁽¹⁾		0-30 ⁽¹⁾
Cruise passenger ship having non-conventional propulsion ⁽³⁾	85,000 GT -	n/a	5 ⁽²⁾	20		30	
	25,000 - 85,000 GT	n/a	0-5 ⁽¹⁾⁽²⁾	0-20 ⁽¹⁾		0-30 ⁽¹⁾	

Notes:

- 1 Reduction factor to be linearly interpolated between the two values dependent upon vessel size. The lower value of the reduction factor is to be applied to the smaller ship size.
- 2 Phase 1 commences for those ships on 1 September 2015.
- 3 Reduction factor applies to those ships delivered on or after 1 September 2019, as defined in paragraph 43 of regulation 2.

Table 8-9 Parameters for Determination of Reference Values for Different Ship Types

Ship type defined in 3.1.2	<i>a</i>	<i>b</i>	<i>c</i>
(4) Bulk carrier	961.79	(i) Deadweight of the ship (referred to as “DWT” hereinafter in this Table) where $DWT \leq 279,000$ (ii) 279,000 where $DWT > 279,000$	0.477
(5) Gas carrier	1120.00	DWT	0.456
(6) Tanker	1218.80		0.488
(7) Container carrier	174.22		0.201
(8) General cargo ship	107.48		0.216
(9) Refrigerated cargo carrier	227.01		0.244
(10) Combination carrier	1219.00		0.488
(12) Ro-ro cargo ship (vehicle carrier)	$(DWT/GT)^{0.7} \times 780.36$ where $DWT/GT < 0.3$, 1812.63 where $DWT/GT \geq 0.3$		
(13) Ro-ro cargo ship	1405.15	DWT	0.498
	1686.17 ⁽¹⁾	(i) DWT where $DWT \leq 17,000^{(1)}$ (ii) 17,000 where $DWT > 17,000^{(1)}$	
(14) Ro-ro passenger ship	752.16	DWT	0.381
	902.59 ⁽¹⁾	(i) DWT where $DWT \leq 10,000^{(1)}$ (ii) 10,000 where $DWT > 10,000^{(1)}$	
(17) LNG carrier	2253.7	DWT	0.474
(18) Cruise passenger ship having non-conventional propulsion	170.84	Gross tonnage of the ship (GT)	0.214

Note:

- 1 To be used from Phase 2 and thereafter. These values, however, may also be applied to Phase 1 in cases where deemed appropriate by the Society.

3.5 Required Energy Efficiency Existing Ship Index (Required EEXI) (Regulation 25 of Annex VI)*

1 The attained EEXI of the following (1) to (3) is not to exceed the required EEXI calculated according to the formulae specified below:

- (1) Ships that fall into one or more of the categories in 3.1.4(5), (7), (9), (11), (13) to (15), (21) and (25) to (28).
- (2) Ships that have undergone a major conversion and that fall into one or more of the categories in 3.1.4(5), (7), (9), (11), (13) to (15), (21) and (25) to (28).

$$\text{Attained EEXI} \leq \text{Required EEXI} = (1 - Y/100) \times \text{Reference line value}$$

where

Y: reduction factor specified in Table 8-10 for the required EEXI compared to the EEDI reference line.

Reference line value: $a \times b^{-c}$

a, *b* and *c*: parameters given in Table 8-9. For ro-ro cargo ships and ro-ro passenger ships, the reference line value to be used from phase 2 and is to be referred to thereafter as such.

2 If the design of a ship allows it to fall into more than one of the above ship type definitions, the required EEXI for the ship is to be the most stringent (i.e. the lowest) required EEXI.

Table 8-10 Reduction Factors (%) for EEXI Relative to the EEDI Reference Lines

Ship Type	Size	Reduction Factors (%)
Bulk Carrier	200,000 DWT –	15
	20,000–200,000 DWT	20
	10,000–20,000 DWT	0–20*
Gas Carrier	15,000 DWT –	30
	10,000–15,000 DWT	20
	2,000–10,000 DWT	0–20*
Tanker	200,000 DWT –	15
	20,000–200,000 DWT	20
	4,000–20,000 DWT	0–20*
Containership	200,000 DWT –	50
	120,000–200,000 DWT	45
	80,000–120,000 DWT	35
	40,000–80,000 DWT	30
	15,000–40,000 DWT	20
	10,000–15,000 DWT	0–20*
General Cargo Ships	15,000 DWT –	30
	3,000–15,000 DWT	0–30*
Refrigerated Cargo Carrier	5,000 DWT –	15
	3,000–5,000 DWT	0–15*
Combination Carrier	20,000 DWT –	20
	4,000–20,000 DWT	0–20*
LNG Carrier	10,000 DWT –	30
Ro-ro Cargo Ship (vehicle carrier)	10,000 DWT –	15
Ro-ro Cargo Ship	2,000 DWT –	5
	1,000–2,000 DWT	0–5*
Ro-ro Passenger Ship	1,000 DWT –	5
	250–1,000 DWT	0–5*
Cruise Passenger Ship Having Non-Conventional Propulsion	85,000 GT –	30
	25,000–85,000 GT	0–30*

Note:

Reduction factor to be linearly interpolated between the two values dependent upon vessel size.

The lower value of the reduction factor is to be applied to the smaller ship size.

3.6 Ship Energy Efficiency Management Plan (SEEMP) (Regulation 26 of Annex VI)*

1 Ships are to maintain on board a ship specific Ship Energy Efficiency Management Plan (SEEMP). This may form part of the ship's Safety Management System (SMS).

2 For ships of 5,000 *gross tonnage* and above, the SEEMP is to include a description of the methodology that is to be used to collect the data required by *Regulation 27.1 of Annex VI* and the processes that are to be used to report the data to the ship's

Administration.

3 SEEMPs are to be developed and reviewed in accordance with guidelines deemed appropriate by the Society.

4 Ships of 5,000 *gross tonnage* and above that fall into one or more of the categories in 3.1.4(5), (7), (9), (11), (13) to (15), (21) and (25) to (28) are to satisfy the following (1) to (3)

(1) SEEMPs are to include the following (a) to (d).

(a) A description of the methodology that is to be used to calculate the ship's attained annual operational CII required by 3.9 and the processes that are to be used to report this value to the ship's Administration

(b) The required annual operational CII, as specified in 3.9, for the next three years

(c) An implementation plan documenting how the required annual operational CII is to be achieved during the next three years

(d) A procedure for self-evaluation and improvement.

(2) For ships rated as D for three consecutive years or rated as E in accordance with 3.9, the SEEMP is to be reviewed in accordance with 3.9.4-2 and is to include a plan for corrective actions for achieving the required annual operational CII.

(3) SEEMPs are to be subject to verification and company audits taking into account guidelines developed by the *IMO*.

5 The Confirmation of Compliance, which indicates that an SEEMP satisfying in -2 and -4(1) above is to be maintained on board.

3.7 Statements of Compliance related to Fuel Oil Consumption Reporting and Operational Carbon Intensity Rating to be kept

In the case of ships to which the requirements of 3.6-2 and 3.6-4 apply, valid Statements of Compliance related to fuel oil consumption reporting which are issued as a result of the requirements specified in 3.8 and 3.9 in accordance with *Regulation 6.6* and/or *Regulation 6.7 of Annex VI* are to be maintained on board for at least five years.

3.8 Data Collection, Reporting and Retained related to Fuel Oil Consumption Reporting, etc. (*Regulations 27 of Annex VI*)*

1 Data collection and reporting to be carried out to obtain the Statements of Compliance required by 3.7 are to be in accordance with the following (1) to (3):

(1) Each ship is to collect the data (i.e. that specified in *Appendix IX of Annex VI*) according to the methodology included in the SEEMP for that and each subsequent calendar year.

(2) The ship is to aggregate the data collected in accordance with the preceding (1) and report them to the Flag Administration or the Society in accordance with the following (a) or (b):

(a) At the end of each calendar year, the ship is to aggregate the data collected in accordance with the preceding (1) in that calendar year or portion thereof and is to report to its Flag Administration or the Society, within three months after the end of each calendar year, the aggregated value for each datum via electronic communication and using a standardized format deemed appropriate by the Society.

(b) Notwithstanding the preceding (a), in cases where a ship is transferred to another Flag Administration or the Company changes, either of the following i) to iii) is to be followed:

i) In the event of the transfer of a ship from one Flag Administration to another:

The ship is, on the day of completion of the transfer or as close as practical thereto, to report to the losing Flag Administration or the Society, the aggregated data, which has been collected in accordance with the preceding (1), for the period of the calendar year corresponding to that Flag Administration and, upon prior request of that Flag Administration, the disaggregated data.

ii) In the event of a change from one Company to another:

The ship is, on the day of completion of the change or as close as practical thereto, to report to its Flag Administration or the Society, the aggregated data, which has been collected in accordance with the preceding (1), for the portion of the calendar year corresponding to the Company and, upon request of its Flag Administration, the disaggregated data.

iii) In the event of change from one Flag Administration to another and from one Company to another concurrently:

The preceding i) is to apply.

(3) The data reported in accordance with the preceding (2) is to be verified according to procedures established by the Flag Administration, taking into account guidelines to be developed by the *IMO*.

2 For ships which maintain on board a Statement of Compliance issued in accordance with *Regulation 6.6 of Annex VI*, disaggregated data that underlies the aggregated data reported in accordance with -1(2)(a) to obtain the Statement of Compliance is to be retained so as to satisfy the following (1) and (2):

- (1) The data is to be readily accessible for a period of not less than 12 months from the end of the calendar year in which the data was collected; and
- (2) The data is to be made available to the Flag Administration upon request.

3.9 Operational Carbon Intensity (*Regulations 28 of Annex VI*)

3.9.1 Attained Annual Operational Carbon Intensity Indicator (attained Annual Operational CII)

1 After the end of calendar year 2023 and after the end of each following calendar year, ships of 5,000 *gross tonnage* and above that fall into one or more of the categories in 3.1.4(5), (7), (9), (11), (13) to (15), (21) and (25) to (28) are to calculate the attained annual operational CII over a 12-month period from 1 January to 31 December for the preceding calendar year, using the data collected in accordance with 3.8, taking into account guidelines developed by the *IMO*.

2 Within three months after the end of each calendar year, the ship is to report to its Administration or the Society the attained annual operational CII via electronic communication and using a standardized format developed by the *IMO*.

3 Notwithstanding -1 and -2 above, in the event of any transfer of a ship addressed in regulations 3.8-1.(2)(b)i, ii) or iii) completed after 1 January 2023, the ship is to, after the end of the calendar year in which the transfer takes place, calculate and report the attained annual operational CII for the full 12-month period from 1 January to 31 December in the calendar year during which the transfer took place, in accordance with -1 and -2 above, for verification in accordance with *Regulation 6.6 of Annex VI*, taking into account guidelines developed by the *IMO*. Nothing in this requirement relieves any ship of its reporting obligations under 3.8 or this requirement.

3.9.2 Required Annual Operational Carbon Intensity Indicator (Required Annual Operational CII)

1 For ships of 5,000 *gross tonnage* and above that fall into one or more of the categories in 3.1.4(5), (7), (9), (11), (13) to (15), (21) and (25) to (28), the required annual operational CII is to be determined as follows:

$$\text{Required annual operational CII} = (1-Z/100) \times CII_R$$

where

Z: annual reduction factor to ensure continuous improvement of the ship's operational carbon intensity within a specific rating level

CII_R : reference value

2 The annual reduction factor Z and the reference value CII_R are to be the values defined taking into account guidelines developed by the *IMO*.

3.9.3 Operational Carbon Intensity Rating

The attained annual operational CII is to be documented and verified against the required annual operational CII to determine an operational carbon intensity rating of A, B, C, D or E, indicating a major superior, minor superior, moderate, minor inferior, or inferior performance level, either by the Administration or the Society, taking into account guidelines developed by the *IMO*. The middle point of the rating level C is to be a value equivalent to the required annual operational CII set out in 3.9.2.

3.9.4 Corrective Actions*

1 Ships rated as D for three consecutive years or rated as E are to develop a plan of corrective actions for achieving the required annual operational CII.

2 SEEMPs are to be reviewed and include an appropriate plan of corrective actions, taking into account guidelines developed by the *IMO*. The revised SEEMP is to be submitted to the Administration or the Society for verification, preferably together with, but in no case later than one month after reporting the attained annual operational CII in accordance with 3.9.1-2.

3 Ships rated as D for three consecutive years or rated as E are to duly undertake planned corrective actions in accordance with the revised SEEMP.

Part 9 CONSTRUCTION AND EQUIPMENT FOR THE PREVENTION FROM SHIPS OPERATING IN POLAR WATERS

Chapter 1 GENERAL

1.1 General

1.1.1 Application*

1 In addition to applicable requirements of the Rules, ships operating in polar waters are to comply with the requirements of this Part.

2 For all hydrofoils, air cushion craft, and other new types of ships (ships proceeding near the sea surface, and ships proceeding under the sea surface, etc.) the application of the requirements in 2.2 concerning the construction and equipment to which is structurally not reasonable or impossible, they may not be applied. However, this relaxation is conditional that equivalent arrangements have been made on the construction and equipment for the prevention of pollution of these ships in consideration of the purpose of service.

1.2 Definitions

1.2.1 Terminology

The definitions of terms which appear in this Part are as specified in (1) to (11) and (25) to (27) of 1.2.1, Part I of the Rules for the Survey and Construction of Steel Ships, unless specified otherwise.

Chapter 2 PREVENTION OF POLLUTION BY OIL

2.1 Shipboard Oil Pollution Emergency Plan and Others

2.1.1 General (*Polar Code*, Part II-A, 1.1.4)

The documents in the following (1) to (5) are to be those where operation in polar waters is taken into account, as appropriate.

- (1) The Oil Record Books specified in 1.2.2, Part 3;
- (2) The Procedures and Arrangements Manual for the approved crude oil washing system specified in 1.3.2-1(1)(b), Part 2;
- (3) The operation manual for the oil discharge monitoring and control system specified in 3.3.1-9, Part 3;
- (4) The clean ballast tank operations manual specified in 4.3.4-4, Part 3; and
- (5) The shipboard oil pollution emergency plan specified in Part 5 or the shipboard marine pollution emergency plan specified in 2.2.3, Part 6.

2.2 Structural Requirements

2.2.1 Fuel Tanks (*Polar Code*, Part II-A, 1.2.1)

For category *A* and *B* ships constructed on or after 1 January 2017 with an aggregate oil fuel capacity of less than 600 m³, all oil fuel tanks are to be separated from the outer shell by a distance of not less than 0.76 m. This provision does not apply to small oil fuel tanks with a maximum individual capacity not greater than 30 m³.

2.2.2 Cargo Tanks Holding Oil (*Polar Code*, Part II-A, 1.2.2)

For category *A* and *B* ships other than oil tankers constructed on or after 1 January 2017, all cargo tanks constructed and utilized to carry oil are to be separated from the outer shell by a distance of not less than 0.76 m.

2.2.3 Cargo Tank Length (*Polar Code*, Part II-A, 1.2.3)

For category *A* and *B* oil tankers of less than 5,000 tonnes deadweight constructed on or after 1 January 2017, the entire cargo tank length is to be protected with:

- (1) double bottom tanks or spaces complying with the applicable requirements of 3.2.4(2)(a), Part 3; and
- (2) wing tanks or spaces arranged in accordance with 3.2.4(1)(a)ii, Part 3 and complying with the applicable requirements for distance *w* referred to in 3.2.4(2)(b), Part 3.

2.2.4 Oil Residue (Sludge) Tanks and Oily Bilge Water Holding Tanks (*Polar Code*, Part II-A, 1.2.4)

For category *A* and *B* ships constructed on or after 1 January 2017 all oil residue (sludge) tanks and oily bilge water holding tanks are to be separated from the outer shell by a distance of not less than 0.76 m. This provision does not apply to small tanks with a maximum individual capacity not greater than 30 m³.

Chapter 3 PREVENTION OF POLLUTION BY NOXIOUS LIQUID SUBSTANCES

3.1 Shipboard Marine Pollution Emergency Plan and Others

3.1.1 General (*Polar Code*, Part II-A, 2.1.2)

The documents in the following (1) to (3) are to be those where operation in polar waters is taken into account, as appropriate.

- (1) The Cargo Record Book specified in [2.2.1-6, Part 4](#);
- (2) The Manual for procedures and arrangements for discharge of noxious liquid substance specified in [2.2.1-5, Part 4](#); and
- (3) The shipboard marine pollution emergency plan for noxious liquid substances specified in [Part 6](#) or the shipboard marine pollution emergency plan specified in [2.2.3, Part 6](#)

3.2 Construction and Equipment

3.2.1 Type of Ships (*Polar Code*, Part II-A, 2.1.3)*

For category *A* and *B* ships constructed on or after 1 January 2017, the carriage of products identified in [Table S17.1, Part S of the Rules for the Survey and Construction of Steel Ships](#), column 'e', as type III ship or identified as products in [Table S18.1, Part S of the Rules for the Survey and Construction of Steel Ships](#) in cargo tanks of type III ships is to be subject to the approval of the Administration.

Appendix I GUIDANCE FOR THE DISCHARGE OF NOXIOUS LIQUID SUBSTANCES, ETC.

1.1 General

1.1.1 Application

This *APPENDIX* gives a reference for approving a procedures and arrangements manual for the discharge of noxious liquid substances, which is required in **2.2.1-5 of Part 4 of the Rules**, by giving guidance for discharging noxious liquid substances or those provisionally assessed as their equivalents and ballast water, tank washings or other residues or mixtures containing preceding noxious liquid substances (hereinafter referred to as the “noxious liquid substances, etc.” in this *APPENDIX*) by using the construction and equipment specified in **Part 4 of the Rules** for the Survey and Construction of Marine Pollution Prevention Installations.

1.1.2 Discharge from Ships en Route (*Regulation 13 of Annex II*)

The discharge into the sea of noxious liquid substances, etc. when the ship is proceeding en route is to be prohibited except when all the following conditions are satisfied:

- (1) The ship is proceeding en route at a speed of at least *7 knots* in the case of self-propelled ships or at least *4 knots* in the case of ships which are not self-propelled;
- (2) The discharge is made below the waterline through the underwater discharge outlet not exceeding the maximum rate for which the underwater discharge outlet is designed. However, for ships constructed before 1 January 2007 the discharge into the sea of residues of substances in Category *Z* or of those provisionally assessed as such or ballast water, tank washings or other mixtures containing such substances below the waterline is not mandatory;
- (3) The discharge is made at a distance of not less than *12 nautical miles* from the nearest land of any one state;
- (4) The discharge is made in a depth of water of not less than *25m*.

1.1.3 Noxious Liquid Substances, etc. Removed by Ventilation Procedures (*Regulation 13.3 of Annex II*)

The requirements of this *APPENDIX* may not apply when the discharge is made of the water filled into the tank after using the ventilation procedures complying with the requirements of **4.6 of Part 4 of the Rules** for removing the cargo residues from the tank.

1.2 Discharge of Noxious Liquid Substances

1.2.1 Category *X* Noxious Liquid Substances, etc.

The discharge into the sea of Category *X* noxious liquid substances, etc. is to be prohibited. If tanks containing such substances or their mixtures are to be washed, the resulting residues are to be discharged to a reception facility until the concentration of the substance in the effluent to such facility is at or below 0.1% by weight and until the tank is empty. Provided that the residue then remaining in the tank is subsequently diluted by the addition of a volume of water, it may be discharged into the sea in accordance with **1.1.2**.

1.2.2 Category *Y* and *Z* Noxious Liquid Substances, etc.

1 With respect to residue discharge procedures for substance in low viscosity and non-solidifying property of Category *Y*, and Category *Z* the discharge standards in **1.1.2** shall apply. If the unloading of a substance in low viscosity and non-solidifying property of Category *Y*, and Category *Z* is not carried out in accordance with the approving a for procedures and arrangements for discharge of noxious liquid substances, a prewash shall be carried out and be discharged to a reception facility at the port of unloading. When a reception facility at another port is available, that reception facility is available.

2 High-Viscosity or Solidify Substances in Category *Y* should not be discharged into the sea. A prewash procedure as specified in **4.2 of Part 4**, and the residue/water mixture generated during the prewash shall be discharge to a reception facility until the tank is empty. Any water subsequently introduced into the tank may be discharged into the sea in accordance with the discharge standard in **1.1.2**.

3 For substances assigned to category *Y* that are persistent floaters with a viscosity equal to or greater than *50 mPa-s* at 20 °C and/or with a melting point equal to or greater than 0 °C , as identified by “**16.2.7**” in column ‘o’ of **Table S17.1 in Part S of Rules**

for the Survey and Construction of Steel Ships, the following are to be applied in the areas (i.e. the North West European waters, Baltic Sea area, Western European waters and Norwegian Sea) indicated in *regulation 13.9 of Annex II*:

- (1) A prewash procedure as specified in **4.2 of Part 4** to this annex is to be applied;
- (2) The residue/water mixture generated during the prewash is to be discharged to a reception facility at the port of unloading until the tank is empty; and
- (3) Any water subsequently introduced into the tank after (1) and (2) above, may be discharged into the sea in accordance with the discharge standards specified in **1.1.2**.

1.2.3 Noxious Liquid Substances, etc. of Undefined Category (*Regulation 13.1 of Annex II*)

The discharge into the sea of “noxious liquid substances, etc.” and “liquid substances, etc. other than noxious liquid Substances” defined in **1.4** is to be prohibited.

1.3 Discharge of Noxious Liquid Substances, etc. in Polar Waters

In the polar waters specified in **1.2.1(25), Part I of the Rules for the Survey and Construction of Steel Ships** any discharge into the sea of Noxious Liquid Substances or mixtures containing such substances is prohibited.

1.4 Liquid Substances, etc. other than Noxious Liquid Substances

The discharge into the sea of substances considered to be harmless for the human health, marine resources and amenity, and other lawful utilization of the sea is not subject to controls. These substances are listed in **Table S17.1** and **Table S18.1 in Part S of Rules for the Survey and Construction of Steel Ships** with an entry “OS” in column ‘c’ in those table.

Contents

GUIDANCE FOR MARINE POLLUTION PREVENTION SYSTEMS	4
Part 1 GENERAL	4
Chapter 1 GENERAL	4
1.1 General.....	4
Chapter 2 TERMINOLOGY AND ABBREVIATIONS.....	6
2.1 General.....	6
Part 2 SURVEYS	7
Chapter 1 GENERAL	7
1.1 General.....	7
1.2 Preparation for Survey and Other Items	8
1.3 Verification Survey of Certificates, etc.	8
1.4 Other	9
Chapter 2 REGISTRATION SURVEYS	10
2.1 Registration Surveys during Construction	10
Chapter 3 REGISTRATION MAINTENANCE SURVEYS	16
3.1 Annual Surveys	16
3.2 Intermediate Surveys.....	16
3.3 Special Surveys.....	17
Chapter 4 OCCASIONAL SURVEYS	18
4.1 General.....	18
Part 3 CONSTRUCTION AND EQUIPMENT FOR THE PREVENTION OF POLLUTION BY OIL ..20	
Chapter 1 GENERAL	20
1.1 Application and Terminology	20
1.2 General Rules	21
Chapter 2 EQUIPMENT FOR THE PREVENTION OF POLLUTION BY OIL FROM MACHINERY SPACES	24
2.2 Storage and Discharge of Oil Residues (Sludge)	24
2.3 Oily-water Separating Equipment, Oil Filtering System, Oil Discharge Monitoring and Control System for Oily Bilge Water, and Oily Bilge Water Holding Tanks	26
Chapter 3 CONSTRUCTION AND EQUIPMENT FOR THE PREVENTION OF POLLUTION BY OIL CARRIED IN BULK	29
3.2 Hull Construction	29
3.3 Installations and Piping Arrangements.....	44
3.4 Crude Oil Washing System	47
Chapter 4 TRANSITIONAL REQUIREMENTS.....	52
4.1 General.....	52
4.3 Equipment for the Prevention of Pollution by Oil Carried in Bulk by Oil Tankers	53
Part 4 CONSTRUCTION AND EQUIPMENT FOR THE PREVENTION OF POLLUTION BY DISCHARGES OF NOXIOUS LIQUID SUBSTANCES IN BULK	55
Chapter 2 CONSTRUCTION AND EQUIPMENT	55

2.2	Requirements for Installation of Construction and Equipment	55
Chapter 4	EQUIPMENT FOR THE PREVENTION OF DISCHARGE OF NOXIOUS LIQUID SUBSTANCES	56
4.2	Prewashing Systems	56
4.3	Stripping System	56
4.4	Discharge Arrangements below the Waterline	56
4.7	Segregated Ballast Tanks	56
Part 5	SHIPBOARD OIL POLLUTION EMERGENCY PLANS	57
Chapter 2	TECHNICAL REQUIREMENTS	57
2.2	Entries in Shipboard Oil Pollution Emergency Plans	57
2.3	Appendices to Shipboard Oil Pollution Emergency Plans	58
Part 6	SHIPBOARD MARINE POLLUTION EMERGENCY PLAN FOR NOXIOUS LIQUID SUBSTANCES	59
Chapter 2	TECHNICAL REQUIREMENTS	59
2.2	Entries in Shipboard Marine Pollution Emergency Plan for Noxious Liquid Substances	59
2.3	Appendices to Shipboard Marine Pollution Emergency Plans for Noxious Liquid Substances 60	
Part 7	EQUIPMENT FOR THE PREVENTION OF POLLUTION BY SEWAGE.....	61
Chapter 2	EQUIPMENT FOR THE PREVENTION OF POLLUTION BY SEWAGE FROM SHIPS 61	
2.2	Requirements for Installation of Equipment	61
Part 8	EQUIPMENT FOR THE PREVENTION OF AIR POLLUTION FROM SHIPS	63
Chapter 1	GENERAL	63
1.1	General.....	63
1.2	General Requirement.....	63
Chapter 2	EQUIPMENT FOR THE PREVENTION OF AIR POLLUTION FROM SHIPS	66
2.1	Nitrogen Oxides (NO _x) (<i>Regulation 13 of Annex VI</i>).....	66
2.2	Sulphur Oxides (SO _x) and Particulate Matter (<i>Regulation 14 of Annex VI</i>).....	69
2.3	Vapour Collection System (<i>Regulation 15 of Annex VI</i>)	69
2.4	Incinerator (<i>Regulation 16 of Annex VI</i>).....	69
Chapter 3	ENERGY EFFICIENCY FOR SHIPS	70
3.1	General.....	70
3.2	Attained Energy Efficiency Design Index (Attained EEDI) (<i>Regulation 22 of Annex VI</i>)	70
3.3	Attained Energy Efficiency Existing Ship Index (Attained EEXI) (<i>Regulation 23 of Annex VI</i>) 70	
3.4	Required Energy Efficiency Design Index (Required EEDI) (<i>Regulation 24 of Annex VI</i>).....	71
3.6	Ship Energy Efficiency Management Plan (SEEMP) (<i>Regulation 26 of Annex VI</i>)	72
3.8	Data Collection, Reporting and Retained related to Fuel Oil Consumption Reporting, etc. (<i>Regulation 27 of Annex VI</i>)	72
3.9	Operational Carbon Intensity (<i>Regulations 28 of Annex VI</i>)	73
Part 9	CONSTRUCTION AND EQUIPMENT FOR THE PREVENTION FROM SHIPS OPERATING IN POLAR WATERS	74
Chapter 1	GENERAL	74
1.1	General.....	74
Chapter 3	PREVENTION OF POLLUTION BY NOXIOUS LIQUID SUBSTANCES	75

3.2 Construction and Equipment	75
Appendix I CONDITION ASSESSMENT SCHEME	76
Resolution <i>MEPC.94(46)</i> adopted on 27 April 2001 and amended by resolutions <i>MEPC.99(48)</i> adopted on 11 October 2002, <i>MEPC.112(50)</i> adopted on 4 December 2003, <i>MEPC.131(53)</i> adopted on 22 July 2005, <i>MEPC.155(55)</i> adopted on 13 October 2006 and <i>MEPC.236(65)</i> adopted on 17 May 2013	76
Appendix 1	87
FORM OF STATEMENT OF COMPLIANCE	87
FORM OF INTERIM STATEMENT OF COMPLIANCE	88
Appendix 2	89
MODEL SURVEY PLAN FOR CAS	89
Appendix 3	97
MANDATORY REQUIREMENTS FOR THE SAFE CONDUCT OF CAS SURVEYS	97

GUIDANCE FOR MARINE POLLUTION PREVENTION SYSTEMS

Part 1 GENERAL

Chapter 1 GENERAL

1.1 General

1.1.1 Application

1 The gross tonnage of ships to which this Guidance applies is to be in accordance with the *International Convention on Tonnage Measurement of Ships, 1969* except where the tonnage is assigned by the flag state government of the ship.

2 The wording “other requirements modified by the Society” in **1.1.1-2 of Part 1 of the Rules** means those in the ClassNK Instructions.

3 For the following equipment not required under the requirements of **1.1.1-3 in Part 1 of the Rules**, the relevant requirements in **Part 2 of the Rules** Surveys, and **Part 3 of the Rules** Construction and Equipment for the Prevention of Pollution by Oil apply. The Rules do not apply to other equipment or construction.

- (1) 100 ppm oily-water separating equipment, and 15 ppm oil filtering system or oil discharge monitoring and control equipment for machinery spaces.
- (2) Oil discharge monitoring and control equipment or oil-water interface detectors for slop tank arrangements.
- (3) Crude oil washing system or insert gas system

4 With respect to the provisions of the Rules for the Marine Pollution Preventing Systems, unless explicitly specified otherwise in the relevant requirements, distances regarding ship length, breadth, depth, and tank length, breadth, height, etc. are to be measured by using moulded dimensions. However, where the effects of plate thickness are not negligible, this requirement is not applicable. For the distance between an independent cargo tank and the hull construction, such distance is to be measured from the external face of the tank.

1.1.2 Equivalent

1 For submersibles, the bilge water holding tanks provided outside the pressure shell, which carry and retain the bilge water generated on board by replacing it with sea water within the tanks may be considered to be equivalent to sludge tanks complying with the requirements of **2.2 in Part 3 of the Rules**, and oil discharge monitoring and control equipment and oily-water separating equipment complying with the requirements of **2.3 in Part 3 of the Rules**. In this case, consideration is to be given so that the mixing of bilge water and sea water can be minimized when bilge water, etc. is replaced with sea water in the tank.

2 The wording “the requirements separately provided by Society” in **1.1.2-2 in Part 1 of the Rules** means liquefied gas carriers in bulk intended to carry noxious liquid substances, at beginning stage of construction before 1 July 1986, and complying with the requirements noted in the right-hand column of **Table 1.1.1-1** according to the classified division of ships. Ships converted into liquefied gas carriers in bulk are dealt with as the liquefied gas carriers in bulk constructed on the date when the conversion work was commenced, irrespective of the date of construction.

3 The requirements of **1.1.2-2(4) in Part 1 of the Rules** may be modified where deemed appropriate by the Society.

Table 1.1.1-1

Classification of ships	Applicable Code
A ship for which contract is placed after 31 October 1976; or in the absence of a contract constructed or ships at beginning stage of construction before 1 July 1983; or a ship completed after 30 June 1984	<i>GC</i> Code ⁽¹⁾
Ship other than the above	<i>EX</i> Code ^{(2) (3)}

Notes:

- (1) *GC* Code is *IMO* Resolution *A. 328(IX)* "Code for the Construction and equipment of Ships Carrying Liquefied Gases in Bulk" (including up the amendments) adopted on 12 November 1975.
- (2) *EX* Code is the "Code for Existing Ships Carrying Liquefied Gases in Bulk" (including up to the amendments) adopted at *IMO* on 12 November 1975.
- (3) Ships completed after 31 October 1976 and before 30 June 1980 are to comply with the *GC* Code as far as practicable.

Chapter 2 TERMINOLOGY AND ABBREVIATIONS

2.1 General

2.1.1 Terminology

1 “Segregated ballast system” specified in **2.1.1(9) in Part 1 of the Rules** means a system completely separated from the cargo pipelines and fuel oil pipelines. Notwithstanding this requirement, however, the segregated ballast water in oil tankers may be discharged in an emergency by connecting the line to the cargo oil pump through a portable spool piece. In this case, a screwed check valve (or combination of a non-screwed check valve and a stop valve) and a stop valve are to be provided at the connection of the segregated ballast tank for preventing the oil from flowing into the segregated ballast tank. The portable spool piece is to be fitted at a conspicuous place of the pump room, where a permanent sign restricting its use is to be fitted at the conspicuous place of the piece (see **Fig. 1.2.1-1**)

2 With respect to the provisions of **2.1.1(15) in Part 1 of the Rules**, the weight of mediums on board for the fixed firefighting systems (e.g. freshwater, CO₂, dry chemical powder, foam concentrate, etc.) is to be included in the lightweight.

Fig. 1.2.1-1

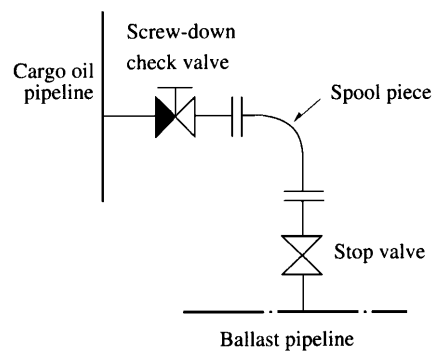

[Fitting a sign board]

Part 2 SURVEYS

Chapter 1 GENERAL

1.1 General

1.1.3 Intervals of Surveys

Occasional surveys specified in **1.1.3-5(3), Part 2 of the Rules** are to be in accordance with the following:

(1) STS operations Plan

For oil tankers delivered before 1 January 2011 that are engaged in the transfer of oil cargo between oil tankers at sea, it is to be confirmed that a STS operations Plan which complies with **1.2.4, Part 3 of the Rules** is provided on board no later than the first Annual, Intermediate or Special Survey conducted on or after 1 January 2011.

(2) Approved Method

For diesel Engines subject to **2.1.1-3, Part 8 of the Rules**, NO_x emissions are to be verified no later than the first Special Survey conducted 12 or more months after the date that the Approved Method is certified by the Administration. However, in cases where the Administration deems that the Approved Method was not commercially available despite best efforts to obtain it, said Approved Method is to be installed on the ship and is to be confirmed no later than the next annual survey of said ship which falls after the Approved Method is commercially available.

(3) Ship Energy Efficiency Management Plan (SEEMP)

(a) For ships to which **Chapter 3, Part 8 of the Rules** applies, which are existing ships as specified in **3.1.2(2) Part 8 of the Rules**, a survey is to be carried out no later than the first Intermediate or Special Survey conducted, whichever is first, on or after 1 January 2013 to confirm that a Ship Energy Efficiency Management Plan (SEEMP) which complies with **3.6, Part 8 of the Rules** is maintained on board.

(b) For ships to which **3.6-2, Part 8 of the Rules** applies which are delivered before 1 March 2018, a survey is to be carried out on or before 31 December 2018 to confirm that the Ship Energy Efficiency Management Plan (SEEMP) includes the description of the methodology and processes specified in **3.6-2, Part 8 of the Rules**.

(c) For ships to which **3.6-4, Part 8 of the Rules** applies which are delivered before 1 November 2022, a survey is to be carried out on or before 1 January 2023 to confirm that the Ship Energy Efficiency Management Plan (SEEMP) includes the description of the methodology and processes specified in **3.6-4(1), Part 8 of the Rules**.

(4) Stability Instruments

For oil tankers subject to **3.2.2-8 to -11, Part 3 of the Rules**, which had been at the beginning stage of construction before 1 January 2016, a survey is to be carried out to verify compliance with the requirements of **3.2.2-8 to -11, Part 3 of the Rules** by the first Special Survey on or after 1 January 2016 but not later than 1 January 2021.

(5) Oil Residues (Sludge) Tank Piping

For ships subject to **2.2.2, Part 3 of the Rules** which were at the beginning stage of construction before 1 January 2017, a survey is to be carried out to verify compliance with the requirements of **3.2.2-1, Part 3 of the Rules** by the first Special Survey carried out on or after 1 January 2017.

(6) Equipment for the Prevention of Pollution by Sewage

For existing passenger ships subject to **Part 7 of the Rules** which operate in the special areas referred to **1.1.2, Part 7 of the Rules** on or after the date specified in **2.2.1(1)(b), Part 7 of the Rules**, a survey is to be carried out to verify compliance with the requirements of **2.2.1(1)(b), Part 7 of the Rules** before such operations.

(7) Exhaust Gas Recirculation System

For ships equipped with the exhaust gas recirculation system specified in **2.1.1-5, Part 8 of the Rules** which were delivered before 1 July 2020, a survey is to be carried out to verify compliance with the requirements of *IMO resolution MEPC.307(73)*

or a standard deemed appropriate by the Administration taking into account this resolution by the first Periodical Survey carried out on or after 1 July 2020.

(8) Ozone Depleting Substances

For ships where “electronic recording system” referred to in *IMO* resolution MEPC.176(58) are provided, a survey is to be carried out to verify compliance with the requirements of **1.2.1-6, Part 8 of the Rules** by the first Special Survey carried out on or after 1 October 2020, but not later than 1 October 2025.

(9) Sampling points for representative sample (in-use samples) of fuel oil

For ships subject to **2.2.2, Part 8 of the Rules** and which were at the beginning stage of their construction on or before 1 April 2022, a survey is to be carried out to verify compliance with the fitting or designating of sampling points specified in **2.2.2-1, Part 8 of the Rules** by the first Special Survey carried out on or after 1 April 2023.

(10) Energy Efficiency Existing Ship Index (EEXI)

(a) For ships to which **Chapter 3, Part 8 of the Rules** applies, a survey is to be carried out no later than the first Annual, Intermediate, Special Survey or the initial survey specified in *Regulation 5.4.1 and 5.4.3 of Annex VI* conducted, whichever is first, on or after 1 January 2023 to confirm that the attained Energy Efficiency Existing Ship Index (attained EEXI) specified in **3.1.4(4), Part 8 of the Rules** complies with **3.3 and 3.5, Part 8 of the Rules**.

(b) Notwithstanding (a), for ships to which **3.3, Part 8 of the Rules** applies, that have undergone a major conversion specified in **3.1.4(16) Part 8 of the Rules**, a general or partial survey, according to the circumstances, is to be carried out to confirm that the attained Energy Efficiency Existing Ship Index (attained EEXI) is recalculated as necessary and complies with **3.5, Part 8 of the Rules**.

1.1.6 Modification of the Requirements

“In cases where considered appropriate” specified in **1.1.6-1, in Part 2 of the Rules** means those cases where examinations are carried out in accordance with measures specially approved by the Society. However, this regulation is not to be applied to surveys required by international regulations or the requirements of flag states.

1.2 Preparation for Survey and Other Items

1.2.5 Procedure for Tests, Wear and Tear, etc.

With respect to **1.2.5, Part 2 of the Rules**, surveyors are to confirm at periodical surveys that asbestos-free declarations and supporting documents are provided for any replaced or newly installed fittings, equipment, parts, etc. The wording “materials containing asbestos” means that asbestos is present in the product/material above the threshold value stipulated in Appendix 1 of *IMO* resolution MEPC.379(80).

1.3 Verification Survey of Certificates, etc.

1.3.1 International Oil Pollution Prevention Certificate, etc. or Equivalent Certificates

In **1.3.1, Part 2 of the Rules**, for International Pollution Prevention Certificate for the Carriage of Noxious Liquid Substances in Bulk, “Equivalent certificate” means International Certificate of Fitness for the Carriage of Dangerous Chemicals in Bulk for new ships; and Certificate of Fitness for the Carriage of Dangerous Chemicals in Bulk for existing ships.

1.3.2 Certificates and Documents other than Those Specified in 1.3.1

1 With respect to the “Records of oil filtering system” specified in **1.3.2-1(1)(i), Part 2 of the Rules**, it is to be confirmed that the records are retained on board for at least 18 *months*.

2 With respect to the “Records of oil discharge monitoring and control system” specified in **1.3.2-1(1)(j), Part 2 of the Rules**, it is to be confirmed that the records are retained on board for at least 3 *years*.

3 With respect to the “Oil Record Book” specified in **1.3.2-1(1)(k), Part 2 of the Rules**, it is to be confirmed that the records are retained on board for at least 3 *years*.

4 With respect to the “EGCS Record Book” specified in **1.3.2-1(3)(k)(i), Part 2 of the Rules** it is to be confirmed that said book has been maintained for a minimum period of 3 *years*. In addition, in the case of exhaust gas cleaning systems which use electronic data recording devices for record keeping purposes, displayed or printed versions of recorded content are to be checked.

5 With respect to the “records of parameters” specified in **1.3.2-1(3)(k)i), Part 2 of the Rules**, all relevant parameters as set out in the SOx Emissions Compliance Plan, EGC system Technical Manual and Onboard Monitoring Manual are recorded and presented in the form of a report.

6 The “manual for EGR bleed-off discharge system” and “EGR record book” specified in **1.3.2-1(3)(l), Part 2 of the Rules** refers to those specified in **2.1.2-2**.

7 The “certificate for type approval” and “operating and maintenance manual” of the relevant oil content meter specified in **1.3.2-1(3)(l), Part 2 of the Rules** refers to the following **(1)** and **(2)**, respectively.

(1) The certificate for type approval of the oil content meter specified in 2.4.2 of *IMO* resolution *MEPC.307(73)*

(2) The operating and maintenance manual of the oil content meter specified in 2.4.3 of *IMO* resolution *MEPC.307(73)*

1.4 Other

1.4.1 Remote Survey

The wording “the Society may approve the survey methods which it considers to be appropriate” in **1.4.1, Part 2 of the Rules** means those survey methods which the Society considers to be able to obtain information equivalent to that obtained through traditional ordinary surveys where a surveyor is in attendance and for which the Administration deems to be appropriate in accordance with 5.14 of *IMO* resolution *A.1186(33)*.

Chapter 2 REGISTRATION SURVEYS

2.1 Registration Surveys during Construction

2.1.2 Submission of Plans and Documents

1 Plans and other documents on the equipment for the prevention of discharge of noxious liquid substances of ships carrying noxious liquid substances in bulk are to be as follows:

(1) Prewash system

Plans and documents showing the following:

- (a) Piping diagram for cargo tank washing
- (b) Specification of tank washing machines noting the rated capacity per cycle, working pressure and effective reach of injection
- (c) Maximum number of tank washing machines which can be used simultaneously
- (d) Location of deck openings for cargo tank washing
- (e) Number of washing machines and location of tank washing on machines necessary for verifying the perfect completion of washing the tank surfaces
- (f) Maximum quantity of washing water that can be heated to 60°C by the heaters provided
- (g) Maximum number of tank washing machines that can be operated simultaneously at the water temperature of 60°C
- (h) Shadow diagram (limited to the case only for tank carrying category X substances or solidify substances, fitted with web frames and struts)
- (i) Calculation sheets of the required amount of washing water for tank washing machines
- (j) Certificates of washing machines (copy)

(2) Stripping system

Plans and documents showing the following:

- (a) Stripping system (including pumping system)
 - i) Cargo piping diagram
 - ii) Cargo pumping system (noting the pumping capacity)
 - iii) Piping diagram of stripping system
 - iv) Pumping system of stripping system (noting the pumping capacity)
 - v) Location of suction points of cargo pipeline and stripping pipeline in each cargo tank
 - vi) Location and size of suction wells, if provided
 - vii) Draining, stripping or blowing systems for pipelines
 - viii) Volume and pressure of the required nitrogen or air, pressure vessels for storage and supply pipe arrangement for the blowing system, where provided
 - ix) Test procedure for assessment of the stripping quantity of residues
 - x) Safety devices for stripping system (including alarms)

(3) Discharge outlet below the waterline

The following plans and documents:

- (a) Discharge outlet below the waterline
 - i) Underwater discharge piping diagram
 - ii) Location, construction, number and dimensions, and calculation sheets of underwater discharge outlets (including the baffle, where provided)
 - iii) Location of the sea inlets relating to underwater discharge outlets

(b) Discharge pump

Specification of pump (including materials used)

(4) Arrangements for discharge to reception facilities

Plans and documents showing the following:

- (a) Specification of pump (including materials used)
 - (b) Discharge piping diagram
- (5) Ventilated washing system

Plans and documents showing the following:

- (a) Names of noxious liquid substances with a vapour pressure of $5kPa$ or more at $20^{\circ}C$, intended to be washed by ventilation procedures, and names of tanks for loading such substances
- (b) Ventilation piping and their fans
- (c) Location of the ventilation opening
- (d) Minimum discharge rate of the ventilation system for adequately flow ventilating the bottom and all other parts of the cargo tank
- (e) Location of structural members inside the cargo tank affecting ventilation
- (f) Means of ventilating the cargo pipelines, pumps, filters, etc.
- (g) Means for ensuring that the tank is dry.
- (h) Certificates (copy) of the fans

2 The “manual for EGR bleed-off discharge system” and “EGR record book” specified in **2.1.2-1(6)(b), Part 2 of the Rules** refers to the following **(1)** and **(2)**, respectively:

- (1) The manual for EGR bleed-off discharge system specified in 2.3.5 and 2.4 of *IMO* resolution *MEPC.307(73)*
- (2) The EGR record book specified in 2.3.4, 2.4, 4.2, and Section 6 of *IMO* resolution *MEPC.307(73)*

3 The “manuals such as operation manuals” and “EGCS Record Book” referred to in **2.1.2-1(6)(c)(i), Part 2 of the Rules** mean the following **(1)** and **(2)**:

- (1) The EGC system Technical Manual specified in 4.2.2 or 5.6 of *IMO* resolution *MEPC.340(77)*, the Onboard Monitoring Manual specified in section 8 of the said resolution, and the SO_x Emissions Compliance Plan specified in section 9.1 of the said resolution; and
- (2) The EGCS Record Book specified in *IMO* resolution *MEPC.340(77)*.

4 Details of the documents related to ship energy efficiency referred to in **2.1.2-3 in Part 2 of the Rules** are as follows:

- (1) The Energy Efficiency Design Index (EEDI) Technical File is a document which contains basic information related to the EEDI calculation conditions. It is to contain the following:
 - (a) Basic data such as either information of the following **i)** to **iii)**, the maximum continuous rating (MCR) of main and auxiliary engines, estimated ship speed and the specific fuel consumption of main and auxiliary engines (Data for each is to be provided. Copies, etc. which indicate the specific fuel consumption of main and auxiliary engines are to be attached.)
 - i) *Gross tonnage* and deadweight (DWT) for ro-ro cargo ships (vehicle carriers);
 - ii) *Gross tonnage* for passenger ships and cruise passenger ships which have non-conventional propulsion; or
 - iii) Deadweight (DWT) for ships other than those mentioned in the preceding **i)** and **ii)**.
 - (b) Power curve(s) (kW – knot) estimated at design stage under the conditions for EEDI calculation as well as power curves estimated under sea trial speed test conditions (Each power curve is to be represented graphically.)
 - (c) Principal particulars as well as overviews of propulsion systems and electricity supply systems (Schematic diagrams, etc. are to be provided.)
 - (d) Power curve estimation process (explanation using process diagrams, etc. of the methodology followed from tank tests to power curve estimation at design stage)
 - (e) Overview of energy saving equipment
 - (f) Attained EEDI calculated values (including the relevant calculation outline)
 - (g) If attained $EEDI_{weather}$ (a value which considers the effects of decreases in speed caused by wind and waves) is calculated, said value as well as the value for f_v (the speed reduction coefficient) used in the calculations are to be provided.
 - (h) For LNG carriers, information specified in the following **i)** to **v)**:
 - i) Type and outline of propulsion systems (such as direct drive diesel, diesel electric, steam turbine);
 - ii) LNG cargo tank capacity in m^3 and the design rate of boil-off gas of entire ship per *day*, which is specified in the

specification of the building contract;

- iii) Shaft power of the propeller shaft after transmission gear at 100% of the rated output of motor and the electrical efficiency for diesel electric;
 - iv) For steam turbines, maximum continuous rated power; and
 - v) For steam turbines, certified specific fuel consumption of the steam turbines measured in g/kWh .
- (i) Other documents deemed necessary by the Society.
- (2) Additional Information (documentation other than that specified in **(1)** above which is needed by the Society to verify the attained EEDI) is, in principal, to contain the following:
- (a) Descriptions of the relevant tank test facility (supporting materials to confirm the reliability of tank tests). This is to include the name of the facility, the particulars of the tanks and towing equipment, and the records of calibration for each piece of monitoring equipment used.
 - (b) Model ship lines and actual ship lines in order to verify the appropriateness of the tank test (Documentation to confirm that the relevant lines are detailed enough to demonstrate the similarity between the model ship and the actual ship)
 - (c) Ship lightweight and displacement table (Documents for deadweight verification)
 - (d) Detailed reports on both tank test results and power curve(s) estimated calculations (Documentation to confirm that the ship speed estimated under EEDI calculation conditions and the ship speed estimated under sea trial speed test conditions were attained using the same calculation process)
 - (e) Reasons for omitting tank tests, if applicable (Documentation which provides appropriate technical justification for omitting tank tests. Such documentation is to include the lines and tank test results of relevant ships of the same type.)
 - (f) For LNG carriers, detailed calculation process of the following **i)** and **ii)**:
 - i) The required auxiliary engine power to supply normal maximum sea load in the condition of the ship engaged in voyage at the specified speed; and
 - ii) For steam turbines, the specific fuel consumption of the steam turbines.
 - (g) Other documents deemed necessary by the Society.

5 The Energy Efficiency Existing Ship Index (EEXI) Technical File referred to in **2.1.2-4, Part 2 of the Rules** is a document which contains the following basic information related to EEXI calculation conditions.

- (1) Basic data such as the information in any of the following **(a)** to **(c)**, the maximum continuous rating (*MCR*) of main and auxiliary engines, estimated ship speed and the specific fuel consumption of main and auxiliary engines (data for each is to be provided, and copies which indicate the specific fuel consumption of main and auxiliary engines are to be attached).
 - (a) *Gross tonnage* and deadweight (*DWT*) for ro-ro cargo ships (vehicle carriers);
 - (b) *Gross tonnage* for passenger ships and cruise passenger ships that have non-conventional propulsion; or
 - (c) Deadweight (*DWT*) for ships other than those mentioned in the preceding **(a)** and **(b)**.
- (2) Limited installed power (MCR_{lim}) (in cases where the SHaPoLi/EPL system is installed).
- (3) Approved power curves ($kW - knot$) estimated at the design stage under the conditions for EEDI calculation as well as power curves, if available, estimated from tank test or numerical calculations (each power curve is to be represented graphically).
- (4) Power curve estimation process (explanation using process diagrams of the methodology followed from tank tests to power curve estimation at the design stage).
- (5) Approximate ship speed obtained by a simplified formula and the calculation process (in cases where the speed-power curve is not available).
- (6) Principal particulars as well as overviews of propulsion systems and electricity supply systems (e.g. schematic diagrams) are to be provided.
- (7) Overview of energy saving equipment.
- (8) Attained EEXI calculated values (including the relevant calculation outline).
- (9) For LNG carriers, the information specified in the following **(a)** to **(g)** is to be included:
 - (a) Type and outline of propulsion systems (such as direct drive diesel, diesel electric, steam turbine);
 - (b) LNG cargo tank capacity (m^3) and the design rate of boil-off gas of entire ship per *day*, which is specified in the specification of the building contract;
 - (c) Shaft power of the propeller shaft after transmission gear at 100 % of the rated output of motor and the electrical efficiency for diesel electric;

- (d) Shaft power of the propeller shaft after transmission gear at the de-rated output of motor (in cases where the SHaPoLi/EPL system is installed);
 - (e) For steam turbines, maximum continuous rated power;
 - (f) For steam turbines, limited maximum continuous rated power (in cases where the SHaPoLi/EPL system is installed); and
 - (g) For steam turbines, certified specific fuel consumption of the steam turbines measured in g/kWh .
- (10) An in-service performance measurement report specified in *IMO resolution MEPC.350(78)* as amended (if applicable).
- (11) Other documents deemed necessary by the Society.

2.1.4 Inspections of Construction and Equipment

1 Inspections of equipment for the prevention of pollution by oil from machinery spaces of all ships are to be carried out in accordance with the following procedures (1) through (5):

- (1) Oily-water separating equipment or oil filtering system are to be tested for function by supplying water or any other suitable liquid.
- (2) Oil discharge monitoring and control equipment is to be tested with actual liquid or by dummy signals to confirm the function of the entire system including the automatic stopping device.
- (3) The alarm devices of the oil content meters of oil filtering system are to be tested for the buzzer operation by energizing the circuits.
- (4) It is to be tested that overall response time between an effluent discharge from the bilge separator exceeding $15ppm$, and the operation of the automatic stopping device preventing overboard discharge is within 20 seconds . In case the tests are carried out by dummy signal of $15ppm$, the time for an effluent passing through the sampling pipe to the oil content meter branched off from the discharge line and the response time of the oil content meter are to be considered.
- (5) Homogenizers are to be tested for function with water or suitable other liquid.

2 Inspections of equipment for the prevention of pollution by oil carried in bulk by oil tankers are to be carried out specifically in accordance with the following procedures (1) through (8):

- (1) At inspections specified in **2.1.4-2(1)(d), Part 2 of the Rules**, it is to be ensured that no leakage is caused by a hydrostatic test carried out at the working pressure.
- (2) Pressure tests for crude oil washing system specified in **2.1.4-2(2)(a)ii), Part 2 of the Rules** are to be carried out either with water or oil for the range as shown in **Fig. 2.2.1-1** between the valve closest to the crude washing pump outlet and the deck piece or thereabouts of the crude washing branch line. The test pressure is to be 1.5 times the working pressure at crude washing as specified in the *COW* procedures and arrangements manual, and pressure measurements are to be taken at the on-deck crude washing main. However, on board pressure tests may be omitted for the portion from the stop valve to the open end, provided that pressure tests are carried out at shop.
- (3) Inspections specified in **2.1.4-2(3)(b)i), Part 2 of the Rules** are to be carried out in accordance with the following procedures :
 - (a) Accuracy of oil content meters is to be verified either by witnessing the calibration tests on board or by examining the calibration records.
 - (b) For automatic effluent discharge stopping devices and their starting interlocking, operations are to be done by dummy signals on oil content, flow rate and ship's speed. Manual discharge stopping function is to be verified by testing.
 - (c) For flow meters, it is to be verified with the actual flow rate at a flow rate of about 50 % of the rated flow of the flow meter that the tolerance in an installed condition is within $\pm 10\%$ of the actual flow rate. Measurements of actual flow rates may be by utilizing tank ullage readings.
 - (d) Functions of the entire system including the operation, recording and alarming are to be verified by dummy signals.
 - (e) Response time (T) of oil content meters is to be within 40 seconds . In this case, verification may be made by using the following formula :

$$T = \frac{0.9\pi L D_i^2}{F} + T_0 \quad (\text{sec})$$

where

L : actual length of sample line (m)

D_i : inside diameter of sample line (mm)

F : flow rate of sampling pump (l/h)

T_0 : response time of the equipment itself noted on the certificate (sec)

- (f) No leakage in the sampling pump and its piping system is to be confirmed. Function of remote controlled valves in the sampling systems, if any, is to be verified. Where sampling probes are fitted in a horizontal section of the discharge line, it is to be verified that the pipe runs full of liquid at all times during the discharge of the effluent.
- (4) Inspections of oil/water interface detectors specified in **2.1.4-2(3)(c), Part 2 of the Rules** are to be carried out in accordance with the following procedures :
 - (a) It is to be verified that oil/water interface detectors are placed on board the ship.
 - (b) Irrespective whether it is of the fixed design or portable one, function to detect the oil/water interface is to be verified. However, if there is a record of shop test carried out within six months, such verification may be omitted. For fixed type oil/water interface detectors, it is to be checked if there are no failures or wear, and proper operations of the detectors are done in their installed condition.
- (5) The wording “interconnecting system for connection to reception facilities” in **2.1.4-2(4)(c), Part 2 of the Rules** means the small diameter discharge pipes connected over boarded of the ships manifold valves specified in **3.3.2-4(2), Part 3 of the Rules**.
- (6) It is to be confirmed with indicators that the closing devices such as valves, etc. specified in **3.2.1(5) and 3.2.1(6), Part 3 of the Rules** can be closed by operations. When the closure is considered to be imperfect, an open up inspection is to be carried out as necessary.
- (7) The watertightness of watertight manhole covers, watertight flush scuttles, small cargo tank hatch covers which maintain the high integrity of the deck, remotely operated watertight sliding doors, hinged watertight access doors with open/closed indication locally and at the navigation bridge of the quick-acting or single-action type that are normally closed at sea, hinged watertight doors that are permanently closed at sea, and side scuttles of the non-opening type approved to be located below the final waterline specified in **3.2.2-3(1), Part 3 of the Rules** is to be verified. Watertightness may be confirmed merely by checking the number of bolts, and the condition of packing. In case of doubt, a hydrostatic test is to be carried out.
- (8) With respect to the operation manuals and the functional tests for stability instruments specified in **2.1.4-2(6)(b), Part 2 of the Rules**, reference is to be made to Chapter 4, Part B of *IMO resolution MSC.267(85) “International Code on Intact Stability, 2008 (2008 IS Code)”*.

Fig. 2.2.1-1

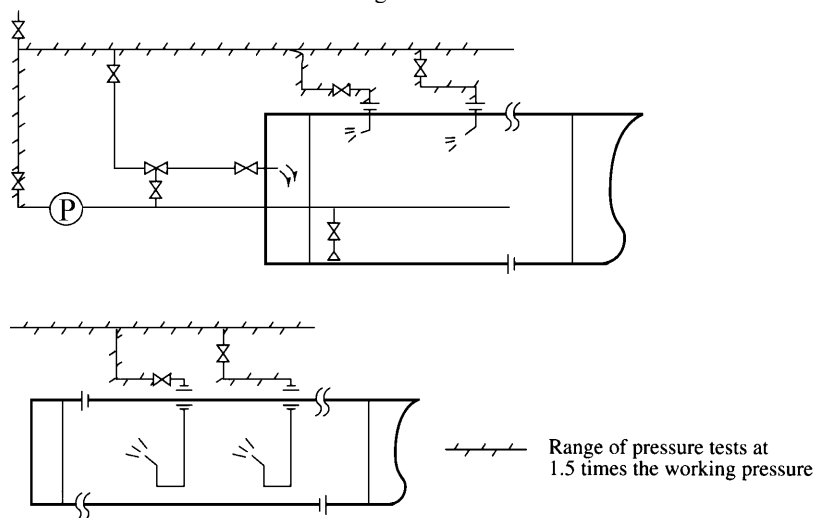

3 Inspection procedures for equipment for the prevention of discharge of noxious liquid substances in ships carrying noxious liquid substances in bulk are to be in accordance with the following procedures **(1)** to **(3)**:

- (1) The Registration Surveys of prewashing system specified in **2.1.4-3(1)(a), Part 2 of the Rules** is to be carried out by operating the system correspondingly in accordance with the washing procedure specified in The Annex II of The International Convention for the Prevention of Pollution from Ships, 1973, as modified by Protocol of 1978 relating thereto (hereinafter referred to as the “Annex II” in this Guidance)

- (2) The wording “water test by an approved procedure” specified in **2.1.4-3(2)(b), Part 2 of the Rules** means the test procedure approved by the Society on the basis of the procedure specified in Appendix 5 of the *Annex II*.
- (3) The Registration Surveys of ventilated washing system specified in **2.1.4-3(8)(a), Part 2 of the Rules** is to be carried out by operating the system correspondingly in accordance with the wash procedure specified in Appendix 7 of the *Annex II*.
- 4** Inspections of the equipment for the prevention of pollution by sewage are to be carried out in accordance with the following **(1)** and **(2)**:
- (1) Inspection items of a sewage treatment plant or a sewage comminuting and disinfecting system are to be as follows:
- Visual inspection
 - Performance tests (including the safety devices and alarms)
- (2) Inspection items of a holding tank are to be as follows:
- Visual inspection
 - Open-up inspection
 - Hydrostatic test with a head of water to the top of tank
- 5** The “examinations of work, such as installation, etc.” referred to in **2.1.4-5(2)(b)i), Part 2 of the Rules** are to be in accordance with the following **(1)** or **(2)**:
- (1) For ships where exhaust gas cleaning systems are installed, satisfactory installation of the exhaust gas cleaning systems is to be examined in accordance with the requirements of *IMO* resolution *MEPC.340(77)* (excluding 4.2.2 and 5.6, sections 8 and 9.1 of the resolution), unless the instructions by the Administration are to be followed.
- (2) For ships where other technological methods are adopted, satisfactory installation of the methods is to be examined.
- 6** The “performance tests” referred to in **2.1.4-5(2)(b)ii), Part 2 of the Rules** are to be in accordance with the following **(1)** or **(2)**:
- (1) For ships where exhaust gas cleaning systems are installed, satisfactory operation of the exhaust gas cleaning systems is to be examined in accordance with the requirements of *IMO* resolution *MEPC.340(77)*, unless the instructions by the Administration are to be followed.
- (2) For ships where other technological methods are adopted, satisfactory operation of the methods is to be examined.
- 7** In applying **2.1.4-5(3), Part 2 of the Rules**, the definitions of terms which appear in said paragraph are as specified in **1.1.2, Part 8 of the Rules**.
- 8** The wording “diesel engines deemed necessary by the Society” in **2.1.4-5(3)(a), Part 2 of the Rules** means diesel engines except those whose NO_x emissions are verified on board using the same method as the measurement procedures for emission verification on a test bed in accordance with 2.2.4.1 of the *NO_x Technical Code*, or which are verified using the on-board simplified measurement method in accordance with 2.2.5.2 of the *NO_x Technical Code*.
- 9** The wording “where deemed appropriate by the Society” in **2.1.4-5(3)(a), Part 2 of the Rules** means where it is considered by the Surveyor upon physical verification that all the other engines and cylinders perform in the same manner as those tested. The verification on a spare may be carried out only where the component represented by the spare part is one which is suitably defined in the approved Technical File on-board NO_x verification procedures.
- 10** The wording “standard deemed appropriate by the Society” in **2.1.4-5(3)(b), Part 2 of the Rules** means Section 7 of *IMO* resolution *MEPC.291(71)*, as amended, or others deemed appropriate by the Administration taking into account this resolution.
- 11** The wording “the tests otherwise specified by the Society” in **2.1.4-5(5)(a), Part 2 of the Rules** means the tests required in 7.2 of *IMO* resolution *MEPC.76(40)* or *MEPC.244(66)* as may be amended. Those tests may be replaced with the verification by the report of the same tests carried out by the manufacturer of the incinerator.
- 12** The wording “the tests otherwise specified by the Society” in **2.1.4-5(5)(c), Part 2 of the Rules** means the tests required in 7.3 of *IMO* resolution *MEPC.76(40)* or *MEPC.244(66)* as may be amended.
- 13** The wording “deemed appropriate by the Society” in **2.1.4-6(1), Part 2 of the Rules** means as follows:
- Ships to which **3.4, Part 8 of the Rules** is not applied.
 - Cases where it is judged that tank test results of other ships of the same type of ship are equivalent.
 - Cases where sea trial speed tests are carried out under draught conditions corresponding to EEDI calculation conditions.
 - Other cases where it is judged that there is an appropriate technical justification for omitting tank tests.

Chapter 3 REGISTRATION MAINTENANCE SURVEYS

3.1 Annual Surveys

3.1.2 Inspections of Construction and Equipment

1 Surveys of equipment for the prevention of marine pollution by oils from machinery spaces of all ships are to be carried out specifically in accordance with the following requirements (1) to (5):

- (1) Functions of an automatic stopping device of oil discharge monitoring and control equipment are to be confirmed by dummy signals.
- (2) In alarming tests of an oil filtering system, functions of buzzers are to be confirmed by energizing the circuit.
- (3) Functions of the automatic stopping device of an oil filtering system are to be confirmed by 15 ppm dummy signals.
- (4) Functions of homogenizers or approved sludge control equipment are to be confirmed by visual inspection.
- (5) Verification of the calibration certificates of the oil filtering equipment is to be in accordance with the following (a) to (c):
 - (a) The validity of calibration certificate is to be checked.
 - (b) It is to be verified that the accuracy of 15 ppm alarms is checked by calibration and testing of the equipment conducted by a manufacturer or persons authorized by the manufacturer.
 - (c) It is to be verified that the calibration and testing specified in (b) above are done at intervals not exceeding five years or within the term specified in the manufacturer's instructions, whichever is shorter.

2 Surveys of equipment for the prevention of pollution by oil carried in bulk by oil tankers are to be carried out specifically in accordance with the following requirements (1) to (4):

- (1) In surveys of segregated ballast tanks specified in **3.1.2-2(1)(c) in Part 2 of the Rules**, the conditions of tanks contiguous to oil tanks, tanks having ballast piping penetrating oil tanks, and tanks through which cargo oil piping or fuel oil piping passes are to be confirmed by visual inspection of pipes and the surface of ballast water, or by surface inspection of ballast water using white cloth.
- (2) Double stop valves specified in **3.1.2-2(2)(c) in Part 2 of the Rules** are to be tested for operability and, in addition, to be visually inspected.
- (3) Functions of automatic stopping devices of oil discharge monitoring and control equipment specified in **3.1.2-2(3)(a)ii in Part 2 of the Rules** are to be confirmed by inputting signals on oil contents, flow rate and ship's speed.
- (4) With respect to the functional tests specified in **3.1.2-2(9), Part 2 of the Rules**, reference is to be made to the requirements related to annual surveys specified in Chapter 4, Part B of *IMO resolution MSC.267(85) "International Code on Intact Stability, 2008 (2008 IS Code)"*.

3 The survey referred to in **3.1.2-4(3)(b), Part 2 of the Rules** is to be in accordance with the following (1) or (2):

- (1) For ships where exhaust gas cleaning systems are installed, satisfactory installation and operation of the exhaust gas cleaning system in accordance with the requirements of *IMO resolution MEPC.340(77)* are to be confirmed according to approved documentation, including sensors monitoring operational or emission parameters as set out in the Onboard Monitoring Manual, unless the instructions by the Administration are to be followed.
- (2) For ships where other technological methods are adopted, the methods are to be examined.

3.2 Intermediate Surveys

3.2.2 Inspections of Construction and Equipment

1 Surveys of equipment for the prevention of pollution by oil from machinery spaces of all ships are to be carried out specifically in accordance with the following requirements (1) through (4):

- (1) Functions of oily-water separating equipment or oil filtering system are to be confirmed by feeding water or suitable other liquid.
- (2) The survey to examine wear of the equipment is to comprise open up inspection of the equipment, attached pumps and major

valves (stop valves fitted to the overboard discharge piping, excluding sea valves), and visual inspection of accessory piping (including plate thickness gauging by test hammering).

- (3) Calibration records of oil content meters are to be confirmed by collating the records with actual buzzer sounds available when inputting 100 ppm signal for the oily-water separating equipment or 15 ppm signal for the oil filtering system.
- (4) Functions of homogenizers or other sludge control equipment are to be confirmed by feeding water or suitable other liquid.

2 Surveys of equipment for the prevention of pollution by oil carried in bulk by oil tankers are to be carried out specifically in accordance with the following requirements (1) through (3).

- (1) Where a flexible hose is used, the hydraulic test with a pressure corresponding to 1.5 times the rated maximum working pressure or more of the hose and 2/5 of the design bursting pressure or less of the hose is to be carried among the inspections of crude oil washing pipelines specified in **3.2.2-2(1)(a), Part 2 of the Rules**.
- (2) Function of the automatic stopping devices for the discharge of effluent and the starting interlock system specified in **3.2.2-2(2)(a), Part 2 of the Rules** is to be confirmed by inputting signals on oil contents, flow rate and ship's speed. Function of the whole system including the operation, recording and alarming are to be confirmed by dummy signals. For the sampling system, no leakage in the sampling pump and its piping system is to be confirmed. Function of remote controlled valves in the sampling systems, if any, is to be confirmed. Inspection of the response time of oil content meters may be confirmed through measuring the flow of sampling pump by using of the formula specified in **2.1.4-2(3)(e), Part 2 of the Guidance**.
- (3) In inspection of oil/water interface detectors specified in **3.2.2-2(4), Part 2 of the Rules**, a operation test is to be carried out in accordance with a operation manual.

3.3 Special Surveys

3.3.2 Inspections of Construction and Equipment

1 The accuracy of flow meters specified in **3.3.2-2(3) in Part 2 of the Rules**, where the system utilizes the flow data from the flow meter, is to be verified by the actual flow rate at a flow rate of about 50 % of the rated flow of the flow meter that the tolerance in the installed condition is within $\pm 10\%$ (within $\pm 15\%$ for ships at beginning stage of construction before 1 January 2005) of the actual flow rate. The actual flow rates may be measured by utilizing tank ullage readings.

2 The wording "Water tests to confirm the amount of residues from stripping" prescribed in **3.3.2-3(2)(a) in Part 2 of the Rules** means tests corresponding to the Registration Surveys.

3 Inspections specified in **3.3.2-4(1), Part 2 of the Rules** are to be carried out in accordance with the following procedures:

- (1) Inspection items of a sewage treatment plant are to be as follows:
 - (a) Inspections in accordance with the requirements specified in **2.1.4-4(1)**
 - (b) Open-up inspections for essential parts
 - (c) Verification whether the disinfectants not to meet the specification required by the plant manufacturer are not infused, by checking maintenance records of the plant
 - (d) Verification of the effluent not to contain any visible solids
- (2) Inspection items of a sewage comminuting and disinfecting system are to be as follows:
 - (a) Inspections in accordance with the requirements specified in **2.1.4-4(1)**
 - (b) Open-up inspections for essential parts
- (3) Inspections of a holding tank are to be carried out in accordance with the requirements specified in **2.1.4-4(2)**. Open-up inspection and hydrostatic test of this tank may be dispensed with, provided that the Surveyor is satisfied with the condition of the tank upon the external examination of the tanks.

4 In applying **3.3.2-2, Part 2 of the Rules**, with respect to the functional tests specified in **3.1.2-2(9), Part 2 of the Rules**, reference is to be made to the requirements related to renewal surveys specified in Chapter 4, Part B of *IMO resolution MSC.267(85) "International Code on Intact Stability, 2008 (2008 IS Code)"*, notwithstanding the requirements of **3.1.2-2(4)**.

Chapter 4 OCCASIONAL SURVEYS

4.1 General

4.1.2 Inspection

1 At Occasional Surveys carried out due to adjustment or modification to a diesel engine outside the approved limits documented in the Technical File specified in **1.1.2(10), Part 8 of the Rules**, it is to be verified that the diesel engine complies with **2.1.1-4, Part 8 of the Rules** and that its NOx emissions are within the limits specified in **2.1.2-1, Part 8 of the Rules** by one of the following (1) to (3). For the purpose of the application of this requirement, IACS Unified Interpretation MPC40(Rev.1) is also to be applied.

- (1) The on-board simplified measurement method specified in the approved Technical File.
- (2) Where the engine is a member of an Engine Group, reference to the test bed testing for the relevant Engine Group approval.
- (3) The on-board direct measurement and monitoring method.

2 At Occasional Surveys carried out due to a major conversion of a diesel engine specified in **1.2.2(13), Part 8 of the Rules**, the diesel engine is to be verified that it complies with **2.1.1-4, Part 8 of the Rules** and to be surveyed in accordance with **2.1.4-5.(3), Part 2 of the Rules**.

3 At occasional surveys carried out in order to verify **2.1.1-3, Part 8 of the Rules**, it is to be verified that NOx emissions are within any of the limits specified in **Tables 8-1(a) to (c), Part 8 of the Rules** by the following (1) or (2):

- (1) It is to be verified that the Approved Method is appropriately installed in accordance with the procedures specified in the Approved Method Technical File.
- (2) In addition to verification of compliance with **2.1.1-4, Part 8 of the Rules**, a survey is conducted in accordance with **2.1.4-5(3), Part 2 of the Rules**.

4 At an occasional survey in the event where the exhaust gas cleaning system to which **1.2.2-1, Part 8** applies is newly installed on board the ship, a survey is to be carried out in accordance with **2.1.2-1(6)(c)** and **2.1.4-5(2)(b), Part 2 of the Rules**.

5 The occasional surveys of ships undergoing a major conversion specified in **3.1.4(16), Part 8 of the Rules** are as follows:

- (1) For any ship intending to undergo an occasional survey, the revised EEDI Technical File or EEXI Technical File as well as supporting documents including at least the following (a) to (d) are to be submitted to the Society for approval before any conversion work is started.
 - (a) Documents explaining the details of the conversion
 - (b) EEDI or EEXI parameters changed after the conversion as well as the technical justifications for each respective parameter
 - (c) Reasons for changes, other than those in (b) above, made to the EEDI Technical File or EEXI Technical File, if any
 - (d) Calculated value of the attained EEDI or EEXI and a calculation overview (This is to contain, at a minimum, each calculation parameter value as well as the calculation process used to determine the attained EEDI or EEXI after the conversion.)
- (2) In cases where a new ship specified in **3.1.4(17), Part 8 of the Rules** undergoes a major conversion, it is to be verified that the attained EEDI is recalculated as necessary and satisfies **3.4, Part 8 of the Rules**, with a reduction factor applicable to the type and size of the converted ship in a phase corresponding to the date of contract or keel laying or delivery determined for the original ship.
- (3) In cases where a major conversion of a new or existing ship is so extensive that the ship is regarded as newly constructed by the Administration and said Administration determines that an initial survey related to the EEDI is necessary, the attained EEDI is to be calculated and satisfy **3.4, Part 8 of the Rules** with the reduction factor applicable corresponding to the type and size of the converted ship at the date of the contract for the conversion, or in the absence of such a contract, the commencement date of the conversion. In addition, it is to be verified that the SEEMP required by **3.6, Part 8 of the Rules** is maintained on board.
- (4) For ships deemed necessary, sea trial speed tests are to be conducted to verify the attained EEDI or EEXI.
- (5) For ships to which **3.6-2, Part 8 of the Rules** applies, it is to be verified that the Ship Energy Efficiency Management Plan (SEEMP) has been revised appropriately to reflect a major conversion in those cases where the major conversion affects the

methodology used to collect the data and/or the processes used to report the data specified in [3.6-2, Part 8 of the Rules](#).

Part 3 CONSTRUCTION AND EQUIPMENT FOR THE PREVENTION OF POLLUTION BY OIL

Chapter 1 GENERAL

1.1 Application and Terminology

1.1.1 Application

1 Discharges related to the operations of fixed and floating platforms which are engaged in exploration and deployment of undersea resources specified in **1.1.1-4 in Part 3 of the Rules** are divided into the following three as shown in **Fig. 3.1.1-1**, where the requirements of **Part 3 of the Rules** apply to **(1)** and **(5)** only:

- (1) Machinery space drainage
- (2) Offshore processing drainage
- (3) Product water discharge
- (4) Displacement water discharge
- (5) Contaminated seawater from operational purposes (such as produced oil tank cleaning water, produced oil tank hydrostatic testing water, water from ballasting of produced oil tank to carry out inspection by rafting)

2 The wording “other guidelines deemed appropriate by the Society” in **1.1.1-4 of Part 3 of the Rules** means “2018 Guidelines for the Application of MARPOL ANNEX I Requirements to Floating Production, Storage and Offloading Facilities (FPSOs) and Floating Storage Units (FSUs)”, IMO resolution MEPC.311(73) as may be amended or what the Government of the concerned coastal State, taking into account this resolution, recognizes as appropriate.

3 For construction and equipment for the prevention of pollution by oil from ships not engaged in international voyages (hereinafter referred to as “non-international ship”) specified in **1.1.1-6 in Part 3 of the Rules**, the requirements in **Part 3 of the Rules** apply except for the following **(1)** to **(6)**:

- (1) The requirements specified in **2.2 in Part 3 of the Rules** do not apply to ships not equipped with propulsion machinery (hereinafter referred to as “non-powered ship”).
- (2) For non-international ships, the requirement specified in **2.2.3 in Part 3 of the Rules** do not apply.
- (3) Equipment to be provided for non-powered oil tankers and non-powered ships other than oil tanker of 100tons gross tonnage or above (excluding ships exclusively engaged in voyages in special areas) in connection with the requirements of **2.4 in Part 3 of the Rules** may be in accordance with **2.3.2(1) in Part 3 of the Rules**.

However, the requirements of **2.3** and **2.4 in Part 3 of the Rules** do not apply to non-powered ships that structurally do not generate oily bilge water, etc.

- (4) The requirements of **3.2.2 in Part 3 of the Rules** do not apply to oil tankers with a length L_f less than 24m.
- (5) The requirements of **3.3.1-1** and **3.3.1-3** to **3.3.1-8 in Part 3 of the Rules** do not apply to any oil tanker which engages exclusively in voyages both of 72 hours or less in duration and within 50 nautical miles from the territorial base line, provided that the oil tanker is engaged exclusively in trades between specific ports or terminals. However, all of the oily mixtures are to be retained on board for subsequent discharges to reception facilities, and such reception facilities are to be sufficient for receiving these oily mixtures.
- (6) For ships constructed or of which keel was laid before 2 October 1983, and ships with length L_f less than 24m, the requirements of **3.2.2 in Part 3 of the Rules** do not apply.

Fig. 3.1.1-1 Discharges from Fixed or Floating Platforms

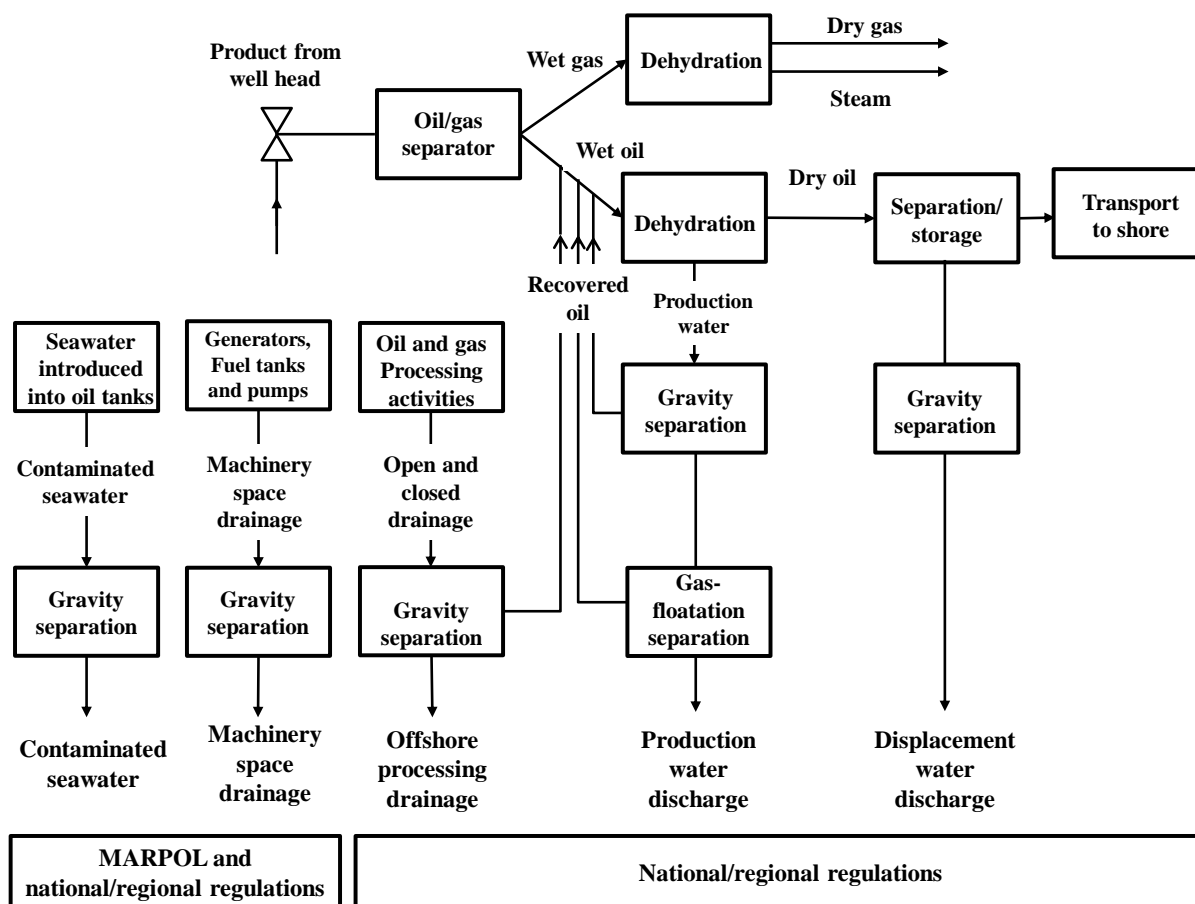

1.1.2 Terminology

1 “Clean ballast” is not required to be discharged via the oil discharge monitoring and control equipment or an oil content meter. However, the ballast water in clean ballast tanks is to be discharged via the oil content meter. As for the discharge of arrival ballast from existing *COW* ships, control of oil content within 15ppm is to be ensured under the responsibility of the ship during the period when the installation of the equipment is being not forced.

2 “Slop tanks” may be used to carry cargo oil if they are not used as shop tanks.

1.2 General Rules

1.2.2 Oil Record Book

The wording “the Guidelines developed by IMO” specified in **1.2.2, Part 3 of the Rules** means the “*Guidelines for the Use of Electronic Record Books under MARPOL (IMO Res. MEPC.312(74))*”.

1.2.3 Oil Fuel Tank Protection

1 For the purpose of the provisions of **1.2.3-5 in Part 3 of the Rules**, the distance *h*, including the bilge area, is to be measured from the bottom shell plating at a right angle to it.

2 For the purpose of the provisions of **1.2.3-5 in Part 3 of the Rules**, the distance *h* for ships designed with a skeg, etc. are to comply with the following (1) and (2):

- (1) Where ships are designed with a skeg, the skeg is not to be considered as offering protection for the fuel oil tanks. For the area within the skeg’s width, the distance *h* is to be measured perpendicular to a line parallel at the intersection of the skeg and moulded line of the bottom shell plating. (See **Fig. 3.1.2-1**)
- (2) Where ship bottom lines longitudinally slope, the distance *h* is to be measured perpendicular to the moulded line of the bottom shell plating at the relevant transverse section where fuel oil tanks are to be protected.

Fig. 3.1.2-1

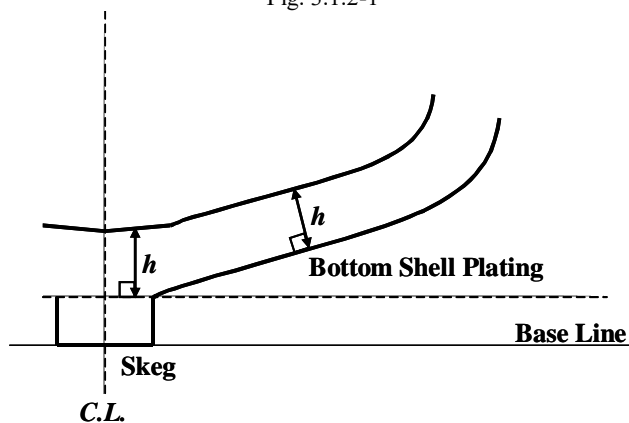

3 For the purpose of the provisions of **1.2.3-5** and **-6** or **-7 in Part 3 of the Rules**, where ship bottom lines transversely rise, the distance $1.5h$ is to be measured from the flat part of the bottom shell plating at a right angle to it. (See **Fig. 3.1.2-2**)

Fig. 3.1.2-2

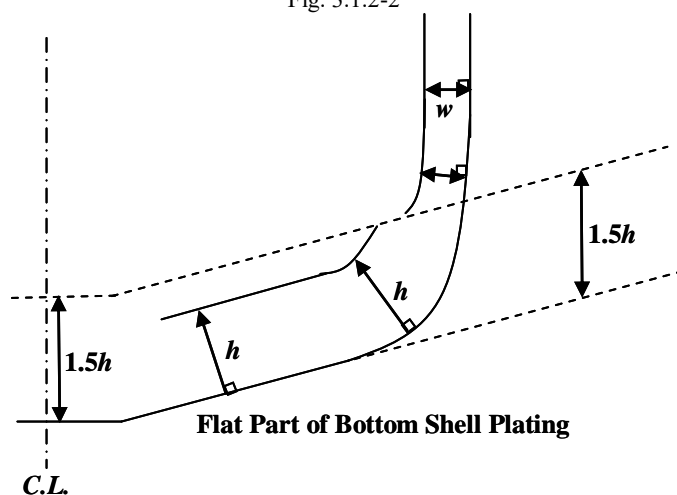

4 Valves or similar closing devices specified in **1.2.3-8 in Part 3 of the Rules** (referred to as valves in this paragraph) are to comply with the following (1) to (3):

- (1) Valves for oil fuel tanks located in accordance with the provisions of **1.2.3-5, -6, or -7 in Part 3 of the Rules** may be treated in a manner similar to the treatment of suction wells as per **1.2.3-9 in Part 3 of the Rules**. (See **Fig. 3.1.2-3**)
- (2) Valves for oil fuel tanks whose locations comply with **1.2.3-10 in Part 3 of the Rules** may be located at a distance less than the distance h (as specified in **1.2.3-5 in Part 3 of the Rules**) or the distance w (as specified in **1.2.3-6 or -7 in Part 3 of the Rules**) **from the ship bottoms or sides**, respectively.
- (3) In any case, these valves are to be fitted immediately adjacent to the oil fuel tanks.

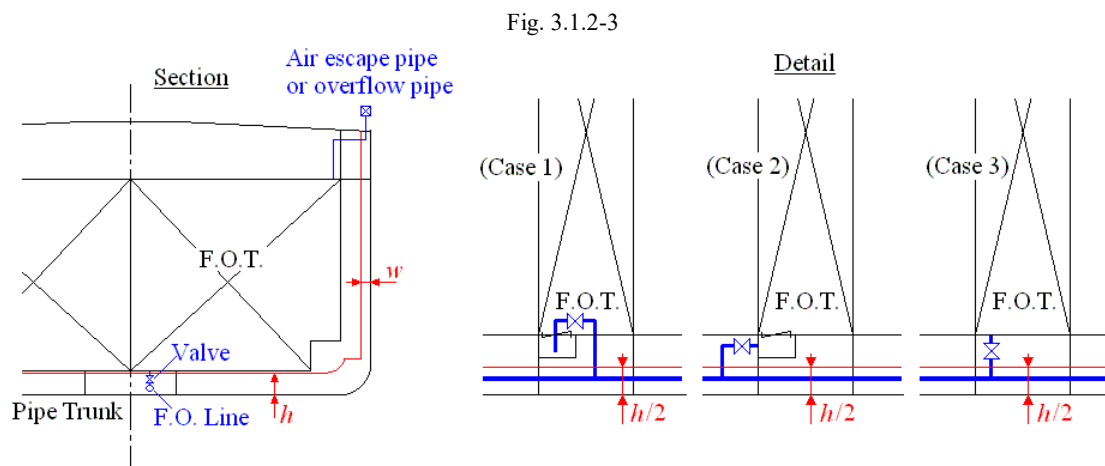

5 With respect to the provisions of **1.2.3-8 in Part 3 of the Rules**, fuel tank air escape pipes and overflow pipes need not be considered as part of the “lines of fuel oil piping.”

6 The provisions of the oil outflow parameter specified in **1.2.3-10 in Part 3 of the Rules** is provided based on symmetrical tank arrangements, and therefore all “y” dimensions, as specified in **1.2.3-10(6) in Part 3 of the Rules**, are to be measured uniformly from the same one side of the ship for all tanks of the ship. For asymmetrical arrangements, the oil outflow parameter is to be determined as an average of two outflow values when “y” dimensions are measured from the starboard and port sides.

7 The provisions of **-2** and **-3** are to apply to the distance h specified in **1.2.3-10 (8) in Part 3 of the Rules**.

1.2.4 STS Operations Plan (Regulation 41 of Annex I)

The “STS operations Plan” specified in **1.2.4, Part 3 of the Rules** is to be developed taking into account the following guidance:

- (1) IMO’s “Manual on Oil Pollution, Section I, Prevention”
- (2) The ICS’s and OCIMF’s “Ship-to-ship Transfer Guide, Petroleum”, fourth edition, 2005

1.2.5 Special Requirements for the Use or Carriage of Oils in the Antarctic Area (Regulation 43 of Annex I)

The meaning of “Antarctic Area” in **1.2.5, Part 3 of the Rules** refers to the sea area specified in **1.2.1(26), Part I of Rules for the Survey and Construction of Steel Ships**.

1.2.6 Special Requirements for the Use and Carriage of Heavy Fuel Oils as Fuel in Arctic Waters (Regulation 43A of Annex I)*

The meaning of “Arctic waters” in **1.2.6, Part 3 of the Rules** refers to the sea area specified in **1.2.1(27), Part I of Rules for the Survey and Construction of Steel Ships**.

Chapter 2 EQUIPMENT FOR THE PREVENTION OF POLLUTION BY OIL FROM MACHINERY SPACES

2.2 Storage and Discharge of Oil Residues (Sludge)

2.2.1 Capacity of Oil Residue (Sludge) Tanks

1 Except where it is assigned by the flag state Government of the ship, C and D in the calculation formulae of **2.2.1(1) in Part 3 of the Rules** are to be determined as below:

(1) Fuel oil consumption C

(a) The engine to be calculated is the main engine (the fuel consumption at the maximum continuous rating) and auxiliary engines (half the fuel consumption of all auxiliary engines operated at the maximum continuous rating)

(b) Operating hours are to be as follows:

For ships engaged in international voyage:

24 hours

For non-international ships (smooth water):

8 hours

For non-international ships (coasting):

16 hours

For non-international ships (greater coasting):

24 hours

(2) Maximum number of days of navigation D

For ships engaged in international voyage:

The maximum number of days of navigation between ports where discharges to shore reception facilities are possible or 30 *days*, whichever is less.

For non-international ships (smooth water):

2 days

For non-international ships (coasting):

4 days

For non-international ships (greater coasting):

6 days

2 Volume of tanks of “ships whose building contract is placed before 1 July 2010” referred to in **2.2.1 in Part 3 of the Rules** may be dealt with in the following manner. In such cases, the capacity of such a tank or tanks is to be greater than the sum of the minimum capacities of the individual tanks specified in the following (1) and (2):

(1) The minimum capacity of a tank to receive sludge produced by the purification of fuel oil and lubricating oil is to be V_1 or V_2 specified in the following (a) to (c):

(a) The minimum capacity V_1 of the tank in ships not carrying ballast water in fuel oil tanks, which were at beginning stage of construction before 31 December 1990:

$$V_1 = K_1 C D \text{ (m}^3\text{)}$$

where

$K_1 = 0.01$: heavy fuel oil which is purified before being used by main engine

$K_1 = 0.005$: marine diesel oil or heavy fuel oil but not requiring purification

C : fuel oil consumption (*t/day*)

D : maximum number of days between ports where oil sludge can be discharged ashore (when no detailed data is available, this is to be made greater than 30 *days*)

However, the following values may be used where homogenizer, sludge incinerators or sludge disposal equipment approved by the Society are provided:

$V_1 = 1 (m^3)$: ships of 400 *gross tonnage* and above not exceeding 4,000 *gross tonnage*

$V_1 = 2 (m^3)$: ships of 4,000 *gross tonnage* and above

- (b) The minimum capacity V_1 of the tank in ships not carrying ballast water in fuel oil tanks, which were at beginning stage of construction on or after 31 December 1990:

$$V_1 = K_1 CD (m^3)$$

where

$K_1 = 0.015$: heavy fuel oil which is purified before being used by main engine

$K_1 = 0.005$: marine diesel oil or heavy fuel oil but not requiring purification

C : fuel oil consumption (m^3/day)

D : maximum number of days between ports where oil sludge can be discharged ashore (when no detailed data is available, this is to be made greater than 30 *days*)

However, the following values may be used where homogenizer, sludge incinerators or sludge disposal equipment approved by the Society are provided:

$$V_1 = 0.5K_1CD (m^3)$$

or

$V_1 = 1 (m^3)$: ships of 400 *gross tonnage* and above but not exceeding 4,000 *gross tonnage*

$V_1 = 2 (m^3)$: ships of 4,000 *gross tonnage* and above

whichever is greater

- (c) The minimum capacity V_2 of the tank in ships where ballast water is carried in fuel oil tanks:

$$V_2 = V_1 + K_2 B (m^3)$$

where

V_1 : tank capacity determined either by (a) or by (b) above

$K_2 = 0.01$: where ballast water is carried in heavy fuel oil tanks

$K_2 = 0.005$: where ballast water is carried in marine diesel oil tanks

B = capacity (*tons*) of fuel oil tanks connected to ballast pipelines

- (2) The minimum capacity of the tank to receive the oil residues produced by leaked oil in the machinery space is to be V_3 as specified below.

$$V_3 = V_E + V_L$$

where

V_E : tank capacity for waste oil (m^3)

V_L : tank capacity for leaked oil (m^3)

V_E, V_L are to be determined by the following calculation:

- (a) $V_E = 1.5 n_1 (m^3)$

where

n_1 is the value obtained by the following:

$n_1 = 1$, when the sum of the maximum continuous output of the main engine and auxiliary engines is 1,000kW and below,

n_1 = a value added by 1 for every increment of 1,000kW or fraction thereof for the sum of the maximum continuous output of the main engine and auxiliary engines, when the sum of the maximum continuous output of the main engine and auxiliary engines is over 1,000kW.

However, $V_E = 0$ may be accepted where lubricating oil purifiers are provided and no replacement of lubricating oil is required while the ship is at sea.

- (b) $V_L = D \times 20 \times P / 10^6 (m^3)$

: $P \leq 10,000kW$

$$V_L = D \times (0.2 + 7 \times (P - 10,000) / 10^6) (m^3)$$

: $P > 10,000kW$

where

P : maximum continuous output of main engine (kW)

D : maximum number of days between ports where sludge can be discharged ashore (When no detailed data is available, it is to be 30 *days* or more)

- (c) For ships which were at beginning stage of construction before 31 December 1991, or ships at a similar stage of construction

$$V_3=0 \text{ (m}^3\text{)}$$

- (d) For ships which were at beginning stage of construction on or after 31 December 1991, or ships at a similar stage of construction, the following value may be used for V_L in the preceding formula $V_3=V_E+V_L$

$$V_L = l \times D \text{ (m}^3\text{)}$$

$$l = 0.02 n_2: P \leq 10,000kW$$

$$l = 0.01 (n_2 - 10) + 0.2: P > 10,000kW$$

where

P : maximum continuous rating of main engine (*kW*)

n_2 : values as specified below

$$n_2 = 1 \text{ when } P \leq 1,000kW$$

when P exceeds 1,000*kW*, add one per every fraction thereof

D : the maximum number of days between ports where discharges to shore reception facilities are possible (where no detailed data is available, D is to be 30 or more)

2.2.2 Construction of Oil Residue (Sludge) Tanks and Piping Arrangements

1 In applying **2.2.2-1(6)(b), Part 3 of the Rules**, a screw-down non-return valve is to be provided in lines connecting to common piping leading to standard discharge connections specified in **2.2.3, Part 3 of the Rules**.

2 The discharge capacity of pumps of “ships whose building contract is placed before 1 July 2010” referred to in **2.2.2-2(3), Part 3 of the Rules** may be dealt with in the following manner:

- (1) The pumping rate of “ships which were at beginning stage of construction before 31 December 1991” is to be the following Q_1 or Q_2 , whichever is greater.

$$Q_1 = V/t \text{ (m}^3\text{/h)}$$

where

V : V_1 or V_2 specified in **2.2.1-2(1), Part 3 of the Rules** of the Rules

t : 6 *hours*

Ships with a gross tonnage exceeding 1,000 *tons*

$$Q_2 = 5.0 \text{ (m}^3\text{/h)}$$

Ships with a gross tonnage of 1,000 *tons* or less

$$Q_2 = 2.5 \text{ (m}^3\text{/h)}$$

- (2) The pumping rate of “ships which were at beginning stage of construction on or after 31 December 1991” is to be the following Q_1 or Q_2 , whichever is the greater.

$$Q_1 = V/t \text{ (m}^3\text{/h)}$$

where

V : V_1 or V_2 specified in **2.2.1-2(1), Part 3 of the Rules** of the Rules

t : 4 *hours*

$$Q_2 = 2.0 \text{ (m}^3\text{/h)}$$

2.3 Oily-water Separating Equipment, Oil Filtering System, Oil Discharge Monitoring and Control System for Oily Bilge Water, and Oily Bilge Water Holding Tanks

2.3.1 Oily-water Separating Equipment

1 The wording “a design approved by the Society” in **2.3.1 in Part 3 of the Rules** means to comply with the resolution of *IMO A. 393 (X)*, to bear a stamp mark (rubber stamp) proving that the item has passed the inspection by the Society and provided with a copy of type approval certificate issued by the Society.

2 The processing capacity of a oily-water separator included in the oily-water separating equipment specified in **2.3.1 in Part 3**

of the Rules is not to be smaller than the values given in Table 3.2.3-1 depending on the size of ships. However, 20% of the values given in the table may be applied to non-powered ships.

Table 3.2.3-1 Processing Capacity of Oily-water Separating Equipment

Gross tonnage (tons)	Processing capacity (m ³ /h)
Less than 1,000	0.00044×gross tonnage
1,000 and over but less than 40,000	0.4+0.00004×gross tonnage
40,000 and over	2

2.3.2 Oil Filtering System

1 The wording “a design approved by the Society” in 2.3.2-1(1) in Part 3 of the Rules, and “an approved type of audible and visible alarm devices” in 2.3.2-1(2) in Part 3 of the Rules mean to comply with the following standards and to have a copy of type approval certificate issued by the Society, the Administration or a competent organization.

- (1) For ships at beginning stage of construction on or after 1 January 2005 and for ships which undergo alteration on or after that date: *IMO Res. MEPC.107(49)*, as amended
- (2) For other ships than above (1) at beginning stage of construction on or after 30 April 1994: *IMO Res. MEPC.60(33)*
- (3) For other ships than above (1) and (2): *IMO Res. A.393(X)*

2 The processing capacity of the 15ppm separator to be included in the oil filtering system in 2.3.2 in Part 3 of the Rules is to be in accordance with 2.3.1-2 of the Guidance.

3 The wording “provisions specified elsewhere” for the piping arrangements for the oil filtering system specified in 2.3.2-2 in Part 3 of the Rules means those in the following (1) through (8):

- (1) The Oil filtering system is to be suitable for shipboard use and to be such that maintenance can be carried out easily.
- (2) A sampling point is to be provided in a vertical section of the water effluent piping as close as is practicable to the 15ppm bilge separator outlet.
- (3) The arrangement on board ship for extraction of samples from 15ppm bilge separator discharge line to the 15ppm bilge alarm is to give a truly representative sample of the effluent with an adequate pressure and flow.
- (4) The capacity of the supply pump is not to exceed 110% of the rated capacity of the 15ppm bilge separator with size of pump and motor.
- (5) The layout of the installation is to be arranged so that the overall response time (including the response time of the 15ppm bilge alarm) between an effluent discharge from the 15ppm bilge separator exceeding 15ppm and the operation of the automatic stopping device preventing overboard discharge is to be as short as possible and in any case not more than 20 seconds.
- (6) The 15ppm bilge separator is to be fitted with a permanently attached plate giving any operational or installation limits.
- (7) The automatic stopping device specified in 2.3.2-1(3), in Part 3 of the Rules is to consist of a valve arrangement installed in the effluent outlet line of the 15ppm bilge separator which automatically diverts the effluent mixture from being discharged overboard back to oily bilge water holding tanks when the oil content of the effluent exceeds 15ppm.
- (8) Re-circulating facilities are to be provided, after and adjacent to the overboard outlet of the stopping device to enable the 15ppm bilge separator system, including the 15ppm bilge alarm and the automatic stopping device, to be tested with the overboard discharge closed (see Fig.3.2.2-1).
- (9) The fail-safe arrangements to avoid any discharge in case of malfunction of the bilge separator are to be provided.

Fig. 3.2.2-1 Arrangement of Re-circulating Facilities
Oil content meter

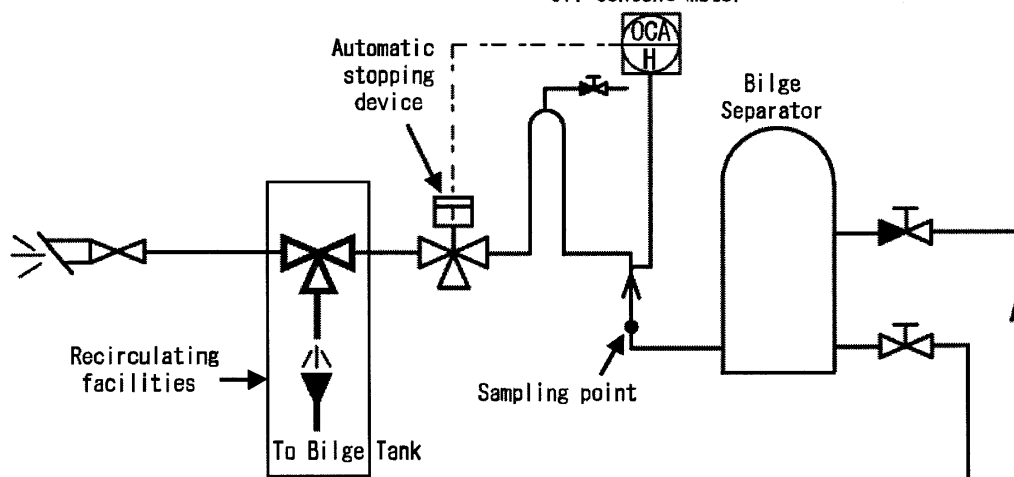

2.3.3 Oil Discharge Monitoring and Control System for Oily Bilge Water

The wording “a design approved by the Society” in **2.3.3, Part 3 of the Rules** is to comply with the resolution of *IMO Res. A.393(X)*, to bear a stamp mark (rubber stamp) proving that the item has passed the inspection by the Society and is provided with a copy of type approval certification issued by the Society.

2.3.4 Oily Bilge Water Holding Tanks

The capacity of oily bilge water holding tanks (C (m^3)) in “ships whose building contract is placed before 1 July 2010, ships with a gross tonnage of less than 400 tons, and oil tankers with a gross tonnage of less than 150 tons” referred to in **2.3.4(1), Part 3 of the Rules** may be greater than the values determined by the following formula.

- (1) Ships which were at beginning stage of construction before 31 December 1991, ships with a gross tonnage of less than 400 tons, and oil tankers with a gross tonnage of less than 150 tons

$$C = (L/V) \cdot Q$$

where

C : capacity of oily bilge water holding tank (m^3)

L : distance of one round trip for the longest trade route in which the ship serves (nautical mile)

V : maximum speed of the ship at sea trials (knot)

Q : the value given in **Table 3.2.3-2** depending on the size of the ship

The maximum value of L/V in the formula may be taken as 16. The minimum value is to be 4.8.

- (2) Ships which were at beginning stage of construction on or after 31 December 1991

- (a) Ships whose maximum continuous output of main engine is less than 1,000kW

$$C = 1.5 (m^3)$$

- (b) Ships whose maximum continuous output of main engine is 1,000kW or more but less than 20,000kW

$$C = 1.5 + (P - 1,000) / 1,500 (m^3)$$

where

P : maximum continuous output of main engine (kW)

- (c) Ships whose maximum continuous output of main engine is 20,000kW or more

$$C = 14.2 + 0.2(P - 20,000) / 1,500 (m^3)$$

where

P : maximum continuous output of main engine (kW)

Table 3.2.3-2 Values of Q

Gross tonnage (tons)	Q (m^3/h)
Less than 1,000	$0.00022 \times \text{gross tonnage}$
1,000 and over but less than 40,000	$0.2 + 0.00002 \times \text{gross tonnage}$
40,000 and over	1

Chapter 3 CONSTRUCTION AND EQUIPMENT FOR THE PREVENTION OF POLLUTION BY OIL CARRIED IN BULK

3.2 Hull Construction

3.2.1 Arrangements of Bulkheads in Spaces Carrying Cargo Oil

1 If an inert gas system is fitted, the normal overpressure specified in **3.2.1-1(7)(c)ii) in Part 3 of the Rules** is to be taken as 5 kPa.

2 The provisions of the oil outflow parameter specified in **3.2.1-1 in Part 3 of the Rules** is provided based on symmetrical tank arrangements, and therefore all “y” dimensions, as specified in **3.2.1-1(8) in Part 3 of the Rules**, are to be measured uniformly from the same one side of the ship for all tanks of the ship. For asymmetrical arrangements, the oil outflow parameter is to be determined as an average of two outflow values when “y” dimensions are measured from the starboard and port sides.

3 With respect to the rigorous calculations specified in **3.2.1-1(10) in Part 3 of the Rules**, reference is to be made to “*Explanatory Notes on matters related to the accidental oil outflow performance*”, adopted by IMO resolution MEPC.122(52).

4 When hypothetical oil outflow of a combination carrier is calculated in applying the requirements of **3.2.1-2(1) in Part 3 of the Rules**, the following procedures are to be complied with:

- (1) The volume of a hatchway up to the top surface of the hatch coaming is to be included in the volume of a cargo oil tank, but the volume of hatch covers may be excluded from the calculation.
- (2) In measuring the moulded volume, no exemption of the volume of internal structures is to be made.

5 When breadth b_i is not constant along the longitudinal direction of a specific wing tank in applying the requirements of **3.2.1-2(2) in Part 3 of the Rules**, the value of b_i for calculating O_C and O_S is to be of the minimum value.

6 The suction wells which are not required in determining the value of h_i under the requirements of **3.2.1-2(2)(c)iii) in Part 3 of the Rules** are those not intended to increase the cargo loading capacity, and in this case, the suction wells may be neglected also for the double bottom segregated ballast tanks in calculating PL . When there are wells within the extent of damage in damage stability calculations, and their depth does not exceed 1/2 of the depth of the double bottom, cargo oil tanks are not considered to be damaged and flooded even if the wells are damaged.

7 The measuring method of the length of tanks when corrugated bulkheads are involved under the requirements of **3.2.1-2(4) in Part 3 of the Rules** is to be as shown in **Fig. 3.3.2-1**.

8 The closing devices to be provided in the pipelines having open ends in cargo tanks specified in **3.2.1-2(6) in Part 3 of the Rules** are to be in accordance with the following requirements. As shown by *1 in **Fig. 3.3.2-2(1)**, each suction valve in branch suction lines is, as a rule, to be provided in each open space (inside the each tank) (excluding the case as shown in **Fig. 3.3.2-2(2)**). However, when arrangements and installations of valves considered to be equivalent to the above are made against the extended outflow of cargo due to damage to the cargo tanks, a valve *2 may be provided in the adjacent tank. When a valve is provided in an adjacent tank, it is to be arranged on the longitudinal bulkhead side of the line drawn from the intersection of the longitudinal bulkhead line and bottom line to form an angle of 45 degrees with the bottom line.

- (1) From the viewpoints of the control value of hypothetical oil outflow and damage stability considerations, this is the installation requirement even for a case that the valve is not required, for preventing the extension of oil outflow.
- (2) In the cases of the following **examples 1) and 2)**, no valve may be provided in respective tanks.

Example 1) When the pipeline passing the cargo tank is outside the extent of damage. (see **Fig.3.3.2-2(2)**)

Example 2) In the case of the right-hand sketch as seen in ore/oil combination carriers, if the strength and pipe wall thickness of the distance piece is equal to the strength and thickness of the bulkhead, and the length is shortest required for valve installation. (see **Fig.3.3.2-2(3)**)

Fig. 3.3.2-1 Length of Tank when Corrugated Bulk-head (s) are Involved

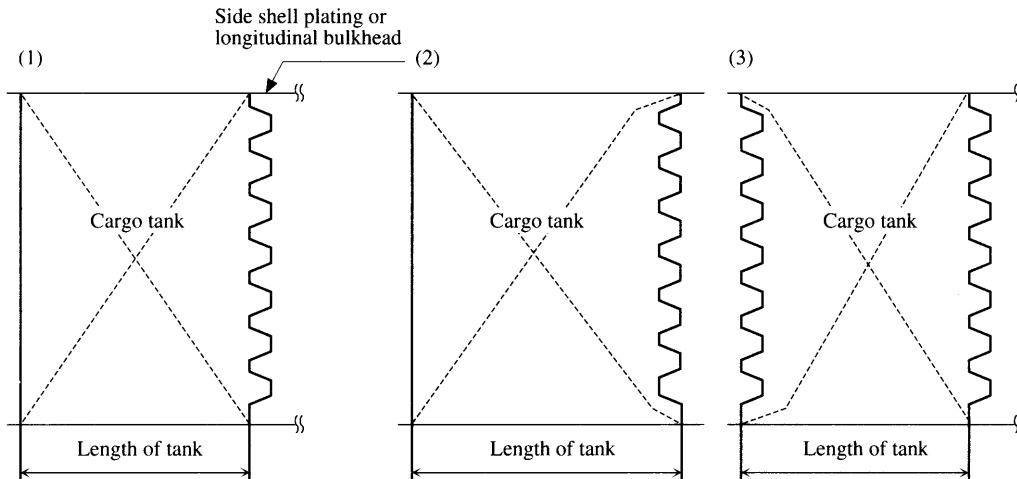

Fig. 3.3.2-2(1) Closing Appliance of Pipelines Having Open Ends in Cargo Oil Tank

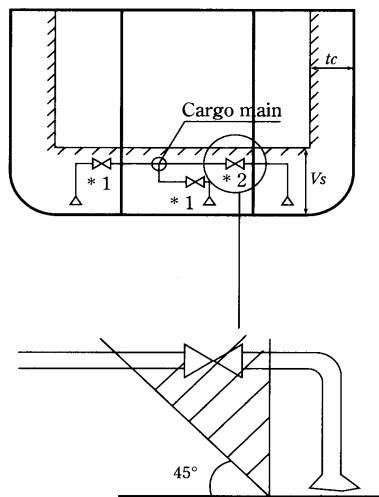

Fig. 3.3.2-2(2)

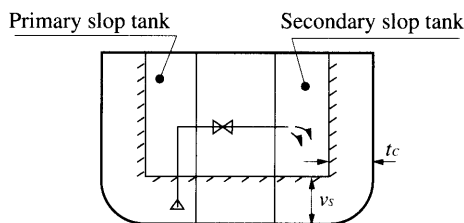
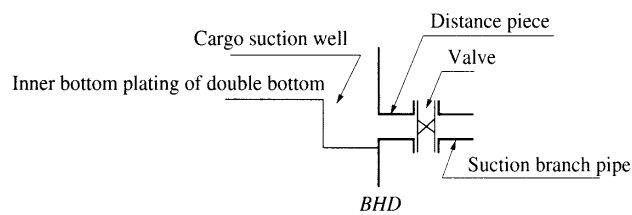

Fig. 3.3.2-2(3)



3.2.2 Subdivision and Stability

1 “Machinery spaces” specified in **3.2.2-1(2) in Part 3 of the Rules** are to be dealt with in accordance with the following requirements:

- (1) Pump rooms are to be dealt with as independent compartments.
- (2) The fuel oil tanks extruded to machinery space are to be dealt with as in **(a)** or **(b)** below.
 - (a) When l in the sketch below is less than $3.05m$, the hatched section is to be dealt with as machinery space.
 - (b) When l in the sketch below is $3.05m$ or more, the hatched section is to be dealt with as a machinery space.

Fig. 3.3.2-3(1)

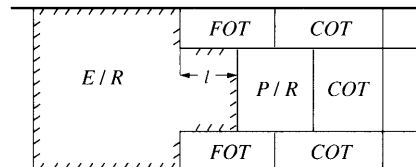
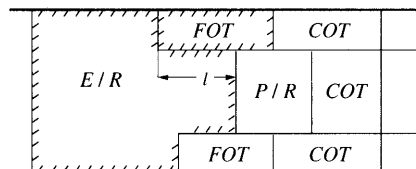

Fig. 3.3.2-3(2)



2 Relaxation of the requirements for oil tankers with L_f less than $100m$ specified in **3.2.2-1(3) in Part 3 of the Rules** applies in accordance with the following:

- (1) The requirements of **3.2.2-2 in Part 3 of the Rules** applies to the extent of hypothetical damage.
- (2) The final condition of flooding after sustaining the hypothetical damage, the damaged stability of ships is to comply with the following requirements:
 - (a) Oil tankers with L_f of $60m$ or more (excluding oil tankers engaged in smooth water areas)
 - i) The sea water inlet is to be above the waterline.
 - ii) The angle of heel is to be 25 degrees or less (30 degrees when the bulkhead deck edge does not submerge in water)
 - iii) The area enveloped by the righting lever and abscissa (hereinafter referred to as “GZ area”) is $0.0175m \cdot \text{radian}$ or more.
 - (b) Oil tankers with L_f of $24m$ or more but less than $60m$ (excluding oil tankers engaged in smooth water areas)
 - i) The GZ area is to be $0.0088m \cdot \text{radian}$ or more.
 - ii) The acceptance criteria of the preceding **(a)i)** and **ii)**.
 - (c) Oil tankers with L_f of $24m$ or more which are engaged in smooth water areas, and oil tankers engaged in international voyages with L_f of less than $24m$.
 - i) The GZ area is to be $0.0044m \cdot \text{radian}$ or more.
 - ii) The acceptance criteria of the preceding **(a)i)** and **ii)**.

3 If $l_1, l_2 \geq l_c$ in oil tankers with L_f of $150m$ or less specified in **3.2.2-1(3) in Part 3 of the Rules**, it may be assumed that BHD_1 do not damage even if $h < v_s$ (see **Fig. 3.3.2-4**).

Fig. 3.3.2-4
BHD_{1,2}

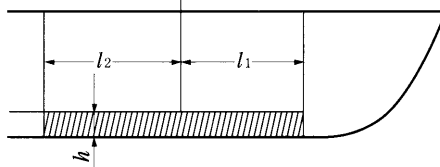

4 For the purpose of the requirements of **3.2.2-2(4) in Part 3 of the Rules**, the intervals of bulkheads relating to damage including the transverse watertight bulkheads in the case of arrangement as shown in 1) 2) 3) of **Fig. 3.3.2-5** are to be considered to cover three floodable compartments. When adjacent bulkheads are arranged so that $l_3 = l_c$ as shown in 3) 4), the intervals may be dealt with as they cover two floodable compartments.

Fig. 3.3.2-5

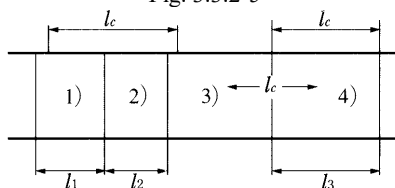

5 For the purpose of the requirements of **3.2.2-2(5)(a) in Part 3 of the Rules**, when L_f is 150m or less, either the following (1) or (2) is to be complied with:

(1) Where the assumed length of damage $l_2 < l_c$:

When $l_1 + l_2 \geq l_c$ and $l_2 + l_3 \geq l_c$, damage A and damage B may be considered to occur independently.

(2) Where the assumed length of damage $l_2 \geq l_c$:

Only in the case of $l_1, l_3 \geq l_c$, it may be dealt with as independent damage C, D and E.

Fig. 3.3.2-6(1)

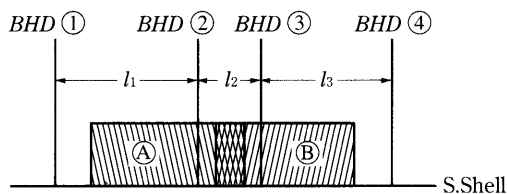
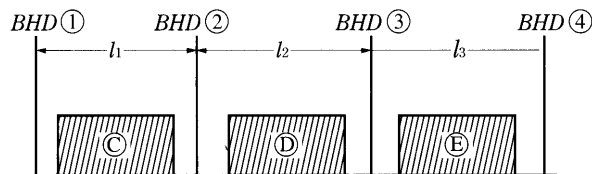

Fig. 3.3.2-6(2)



6 For the purpose of the requirements of **3.2.2-2(5)(b) in Part 3 of the Rules**, when L_f is 150m or less, either of the following (1) or (2) is to be complied with:

(1) Where $l_0 \geq 3.05$ (m)

Simultaneous flooding of compartment A and compartment B is to be considered even if $l_1 - l_0 \geq l_c$.

(2) In the case of the stepped bulkhead as shown in **Fig. 3.3.2-7(2)**, APT and E/R may be considered to be sustaining a single flooding irrespective of the value of l_0 .

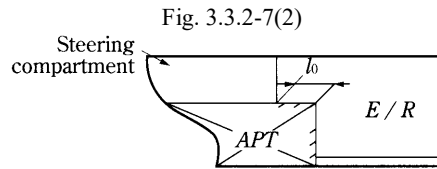
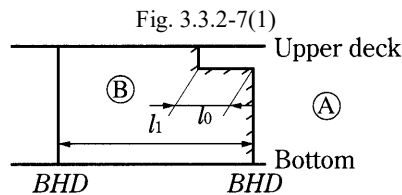

7 The “watertight sliding doors” referred to in **3.2.2-3(1) in Part 3 of the Rules** means such doors satisfying the requirements of **2.2.2, Part 1, Part C of the Rules for the Survey and Construction of Steel Ships**, unless otherwise specified in this chapter.

8 In applying the requirements of **3.2.2-3(3) in Part 3 of the Rules**, “other openings which can be closed with a watertight cover” do not include ventilators provided with watertight closing appliances in accordance with the requirements of **14.12.3.1-3, Part 1, Part C of the Rules for the Survey and Construction of Steel Ships** or **21.6.5-2, Part CS of the Rules** that for operational reasons have to remain open to supply air to the engine room or emergency generator room (if the same is considered buoyant in the stability calculation or protecting openings leading below) for the effective operation of the ship.

9 For the purpose of the requirements of **3.2.2-3(4) in Part 3 of the Rules**, the stability of oil tankers of ordinary design, combination carriers having vertical longitudinal bulkheads at intermediate stages of flooding is to be investigated by comparing them with the final condition of flooding at each case.

10 “The worst possible conditions of cargo and ballast loading during the liquid transfer operations” specified in **3.2.2-6, Part 3 of the Rules** means the following assumed conditions. For the calculating G_0M , the liquid free surface correction is based on the appropriate upright free surface inertia moment. The lighting lever curve may be corrected on the basis of liquid transfer moments.

- (1) All cargo tanks are filled with the cargo to a level corresponding with the maximum combined total of vertical moment of volume plus free surface moment at 0°heel, for each individual tank.
- (2) All ballast tanks are filled with 1% of each ballast tank capacity.
- (3) The maximum free surface moment is considered in all ballast tanks.
- (4) Cargo density ρ is calculated by using the following formula, but may not exceed the value defined in design.

$$\rho = \frac{DWT_{KMmin} - (W_{BW1\%} + W_{CONSUM-FD} + const.)}{V_{CARGO(1)}}$$

DWT_{KMmin} : Cargo deadweight at the displacement at which transverse KM reaches a minimum value (Refer to **Fig. 3.3.2-8**) (t)

$W_{BW1\%}$: 1% weight of the total ballast capacity (t)

$W_{CONSUM-FD}$: Weight of the full departure consumables (t)

$Const.$: Weight of crew, their belongings and stored goods (t)

$V_{CARGO(1)}$: Total cargo capacity in the condition specified in preceding (1) (m^3)

11 Notwithstanding the provisions of -10, the confirmation of a ship complying with the requirements of **3.2.2-6(1) and (2) in Part 3 of the Rules** in every condition as given by the following (1) to (5), may be regarded as a ship complying with the intact stability requirements under the worst possible conditions of cargo and ballast loading during the liquid transfer operations as required in **3.2.2-6 in Part 3 of the Rules**. Sufficient and appropriately varied steps between all limits as given in the following (1), (3) and (4) are to be examined to ensure that the worst conditions are identified. For the draughts as specified in (1), a minimum of 20 steps for the range of cargo and ballast content, between 1% and 99% of total capacity, is to be examined. Where deemed necessary by the Society, more closely spaced steps near critical parts of the range may be required.

- (1) Draught
 - The draughts are to be varied between light ballast and scantling draft.
- (2) Consumables such as fuel oil, diesel oil and fresh water
 - Consumables corresponding to 97%, 50% and 10% content are to be considered.

(3) Ballast and Cargoes

For each draught as specified in (1) and variation of consumables as specified in (2), the available deadweight is to comprise ballast water and cargo, such that combinations between maximum ballast and minimum cargo and vice-versa, are to be covered. In all cases the number of ballast and cargo tanks loaded is to be chosen to reflect the worst combination of vertical centre of gravity and free surface effects. Operational limits on the number of tanks considered to be simultaneously slack and exclusion of specific tanks are not permitted. All ballast tanks are to have at least 1% content.

(4) Cargo densities

Cargo densities between the lowest and highest intended to be carried are to be considered.

(5) Weights, centre of gravity and free surface moment

Weight, centre of gravity co-ordinates and free surface moment for all tanks should be according to the actual content considered in the calculations.

12 “The information for intact stability during the liquid transfer operations as deemed appropriate by the Society” specified in **3.2.2-7, Part 3 of the Rules** means the clear and concise instructions covering the operational restrictions and procedures necessary to ensure the compliance with the intact stability criteria during liquid transfer operations required in **3.2.2-6(1)** and **(2), Part 3 of the Rules**, and :

- (1) is in understandable language by the officer-in-charge of liquid transfer operations;
- (2) requires no extensive mathematical stability calculation by the officer-in-charge of liquid transfer operations ;
- (3) indicates the maximum number of cargo and ballast tanks which may be slack under any condition of liquid transfer;
- (4) provides the pre-planned sequences of cargo/ballast transfer operation; which indicate the cargo and ballast tanks which may be slack to satisfy the stability criteria under any specific condition of liquid transfer, including possible range of cargo density, where the slack tanks may vary during stages of the transfer operations and be any combination which satisfies the stability criteria;
- (5) provides instructions for procedures, in addition to sequences specified in (4), in case when liquid transfer operations are carried out by comparisons of attained and required stability by using stability criteria in graphical or tabular form; and for procedure by using the loading instrument, if any; and
- (6) provides for corrective actions to be taken by the officer-in-charge in case of unexpected technical difficulties with the pre-planned transfer operations specified in (4), and in case of emergency situation.

13 The wording “performance standards recommended by the *IMO*” specified in **3.2.2-8, Part 3 of the Rules** refers to the following (1) to (3):

- (1) Chapter 4, Part B of *IMO resolution MSC.267(85) “International Code on Intact Stability, 2008 (2008 IS Code)”*
- (2) Section 4, Annex to “*Guidelines for the Approval of Stability Instruments*” (*MSC.1/Circ.1229*)
- (3) The technical standards provided in Part 1 of “*Guidelines for Verification of Damage Stability Requirements for tankers*” (*MSC.1/Circ.1461*)

14 In applying the requirements in **3.2.2-11, Part 3 of the Rules**, reference is to be made to the operational guidance provided in Part 2 of “*Guidelines for Verification of Damage Stability Requirements for Tankers*” (*MSC.1/Circ.1461*).

3.2.3 Segregated Ballast Tanks

1 For the purpose of the requirements of **3.2.3(1) in Part 3 of the Rules**, the conditions for segregated ballast tanks of oil tankers with L_f of less than 150m are to satisfy the following formulae:

$$\text{Minimum mean draught } (m) \geq 1.550 + 0.023 L_f$$

$$\text{Maximum trim } (m) \leq 1.600 + 0.013 L_f$$

2 For the purpose of the requirements of **3.2.3(2)(a) in Part 3 of the Rules**, protective arrangements of segregated ballast tanks are to be dealt with as follows:

- (1) $L_t (B+2D)$ apparently assumes a ship of the box design. Accordingly, the protective areas of each segregated ballast tank space may be considered to have rectangular shapes within a reasonable range.
- (2) The range of L_t is guided by the examples as shown in **Fig. 3.3.2-8(1)** and **Fig. 3.3.2-8(2)**.

Fig. 3.3.2-8(1)

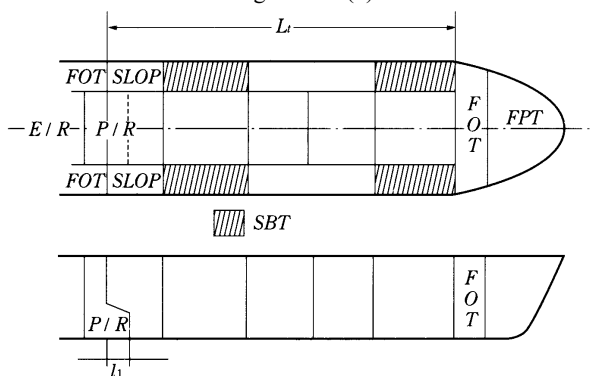

Notes:

l_1 : PAs countable

Fig. 3.3.2-8(2)

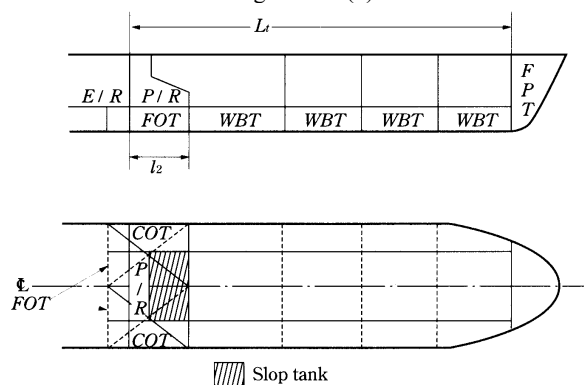

Notes:

l_2 : PAs not to be counted

Fig. 3.3.2-8(3)

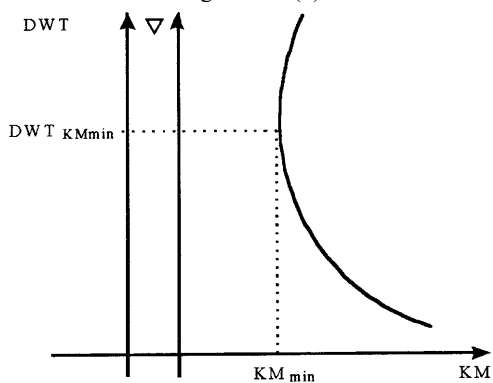

3 For the purpose of the requirements of **3.2.3(2)(c) in Part 3 of the Rules**, the minimum width and minimum depth are to be taken in accordance with the following procedures (1) and (2):

(1) Measurements are to be taken at a position $D/5$ from the mould base line for taking the minimum width of a wing tank. In this case, the width W is to be at least $2m$ for the tank length for calculating P_{Ac} (see **Fig. 3.3.2-9(1)**).

(2) Method of taking the minimum depth of double bottom

Measurements for determining the minimum depth of a double bottom tank are to be taken on a vertical plane which is $D/5$ inboard from the intersecting point on the shell plating at a height $D/5$ from the mould base line (see **Fig. 3.3.2-9(3)**). Here, the depth h is to be $2m$ or $B/15$, whichever is less, for the tank length used for calculating P_{As} .

Fig. 3.3.2-9(1) Measurement of Minimum Width of the Wing Ballast Tank at Ends of Ship

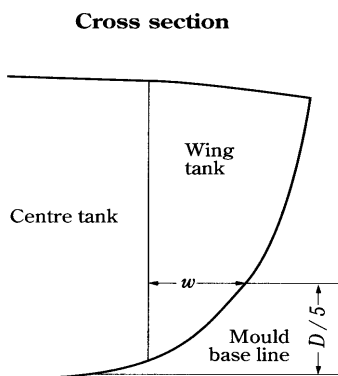
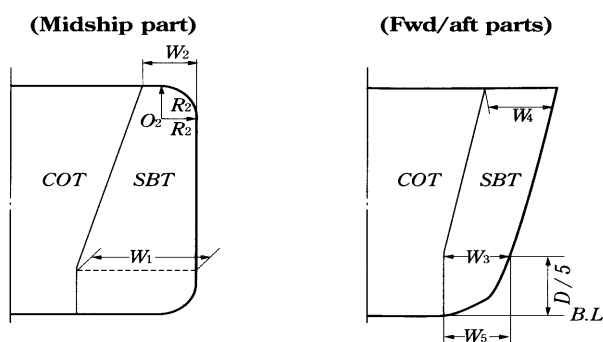

Fig. 3.3.2-9 (2) Minimum Width of Wing SBT



Note:

The minimum width of the wing tank in the example shown in Fig. 3.3.2-9 (2) is as follows:

The minimum width of wing tank
 = $\min (W_1, W_2)$ or $\min (W_3, W_4, W_5)$

Fig. 3.3.2-9(3) Measurement of Minimum Height of Double Bottom Tank at Ends of Ship

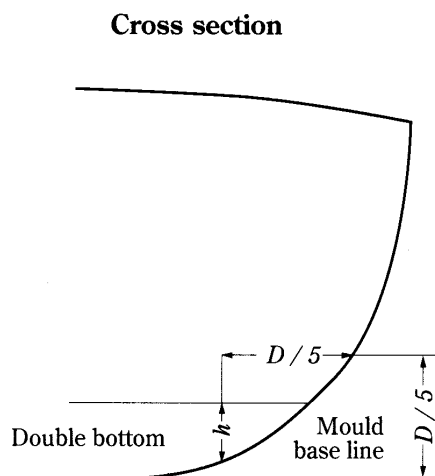

4 For the purpose of the requirements of 3.2.3(2) in Part 3 of the Rules, the calculation methods of and *PAs* are to be in accordance with the following procedures (1) through (4).

- (1) When the minimum width requirement of 2m is not satisfied for the entire length of the wing tank, the value of *PAc* is to be taken as zero, and even when part of the tank exceeds 2m, it is not to be included in *PAc*.
- (2) In including *PAs* in the calculation, when the minimum depth requirement is not satisfied for the entire length of the double

bottom tank, this double bottom tank is not to be included in *PAs*. However, if the bottom area of the cargo tank above is all included in the double bottom area or the area of the compartment meeting the minimum depth requirement, and if the side bulkhead contiguous to the cargo tank is vertical or slanted with an angle of 45 *degrees* or less, the portion of the double bottom tank to which the bottom area of the cargo tank is projected may be included in *PAs*.

- (3) In a similar case as the preceding (2), if the wing tanks above the double bottom tank are either the segregated ballast tank or void space, such a space may be included in *PAs* in calculation. However, *PAs* in the former and *PAc* in the latter may be included in the calculation for that portion, provided that the vertical and horizontal protective areas satisfy the minimum distance requirement specified in 3.2.3(2)(c) in Part 3 of the Rules.
- (4) The measuring method of projected areas is to be in accordance with examples given in Fig. 3.3.2-10(1) to Fig. 3.3.2-10(10). Fig. 3.3.2-10(11) and Fig. 3.3.2-10(12) show the measuring method of depth in calculating *PAc* of a double bottom tank with slanted tank top plating.

Fig. 3.3.2-10(1) Calculation of *PAc* and *PAs* for Double Bottom Tank Amidships

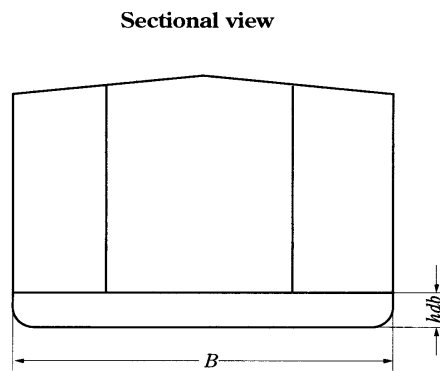

Notes:

When *hdb* is greater than 2m or *B*/15, whichever is less for the entire length of the tank

$$P_{Ac} = hdb \times (\text{length of double bottom tank}) \times 2$$

$$P_{As} = B \times (\text{length of double bottom tank})$$

When *hdb* is less than 2m or *B*/15, whichever is less for the entire length of the tank

$$P_{Ac} = hdb \times (\text{length of double bottom tank}) \times 2$$

$$P_{As} = 0$$

Fig. 3.3.2-10(2) Calculation of P_{Ac} and P_{As} for Double Bottom Tank at Ends of Ship

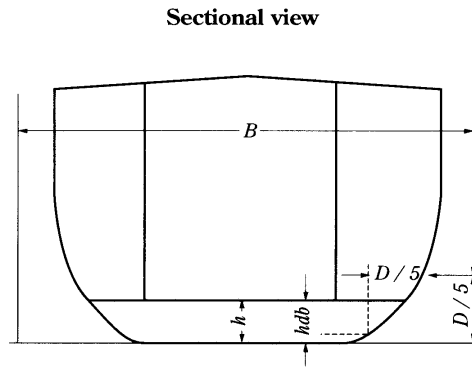

Notes:

When hdb is greater than $2m$ or $B/15$, whichever is less

$$P_{Ac} = h \times (\text{length of double bottom tank}) \times 2$$

$$P_{As} = B \times (\text{length of double bottom tank})$$

When hdb is less than $2m$ or $B/15$, whichever is less

$$P_{Ac} = h \times (\text{length of double bottom tank}) \times 2$$

$$P_{As} = 0$$

Fig. 3.3.2-10(3) Calculation of P_{Ac} and P_{As} for Wing Tank Amidship

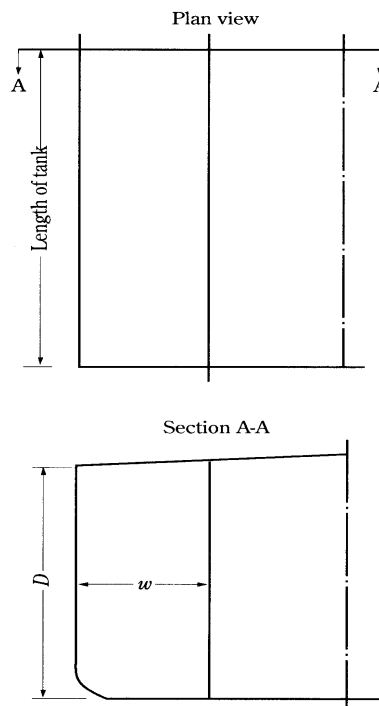

Notes:

When w is $2m$ or more

$$P_{Ac} = D \times (\text{length of tank}) \times 2^*$$

$$P_{As} = w \times (\text{length of tank}) \times 2^*$$

When w is less than $2m$

$$P_{Ac} = 0$$

$$P_{As} = w \times (\text{length of tank}) \times 2^*$$

*Include both sides

Fig. 3.3.2-10(4) Calculation of P_{Ac} and P_{As} for Wing Tank End of Ship

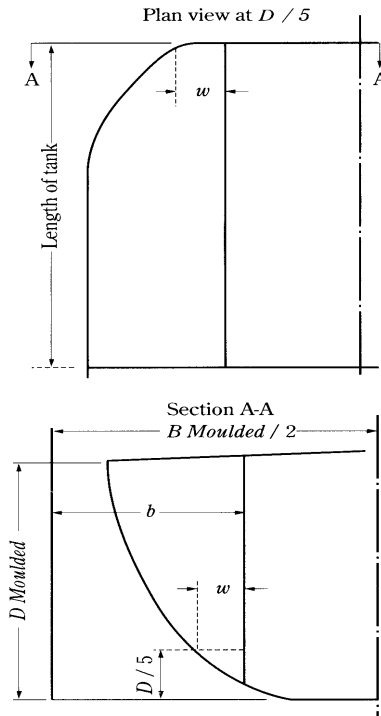

Notes:

When w is 2m or more

$$P_{Ac} = D \times (\text{length of tank}) \times 2^*$$

$$P_{As} = b \times (\text{length of tank}) \times 2^*$$

When w is less than 2m

$$P_{Ac} = 0$$

$$P_{As} = b \times (\text{length of tank}) \times 2^*$$

*Include both sides

Fig. 3.3.2-10(5) Calculation of P_{As} of a Double Bottom Tank for which the Curvature of the Turn of Bilge Stake is Not Specified-when the Wing Tank is Cargo Tank

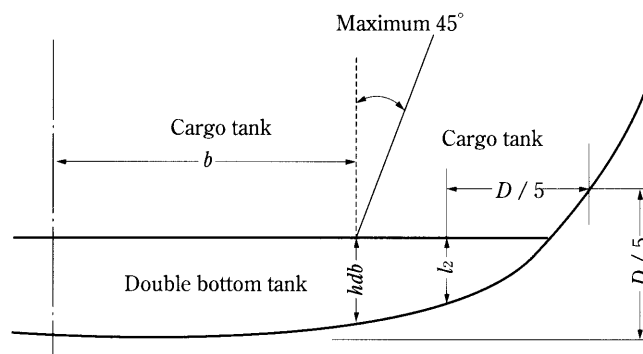

Notes:

When h is less than 2m or $B/15$, whichever is less, but hdb is greater than 2m or $B/15$, whichever is less within the range of width $2b$ at any point along the entire length of the tank, $P_{As} = 2b \times (\text{length of cargo tank})$

Fig. 3.3.2-10(6) Calculation of *PAs* of a Double Bottom Tank for which the Curvature of the Turn of Bilge Stake is Not Specified-When the Wing Tank is Segregated Ballast Tank or Void Space

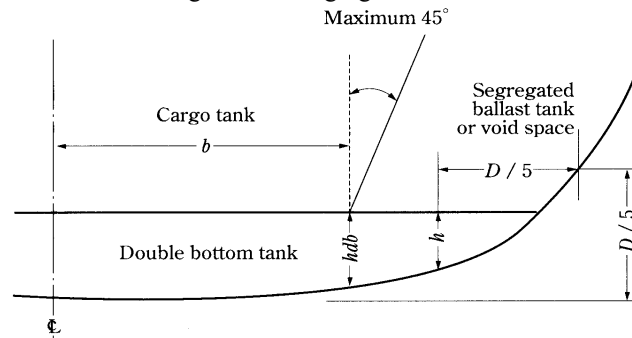

Notes:

When h is less than $2m$ or $B/15$, whichever is less, but hdb is greater than $2m$ or $B/15$, whichever is less within the range of width $2b$ at any point along the entire length of the tank, $PAs = B \times (\text{length of cargo tank})$

Fig. 3.3.2-10(7) Counting Partial Double Bottom Segregated Ballast Tank in *PAs* and *Pas*

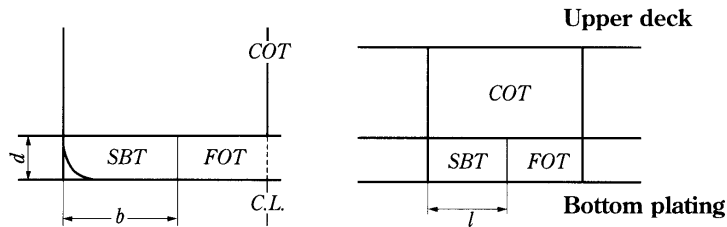

Notes:

PAs : The partial double bottom segregated ballast tank that satisfies the condition to count into *PAs* may be counted in *PAs* for breadth b and length l .

PAc : When $b \geq 2(m)$, it may be counted in *PAc* for depth d .

Fig. 3.3.2-10(8) Counting *PAs* and *PAc* for Fore and Aft Ballast Tanks and Double Bottom Ballast Tanks

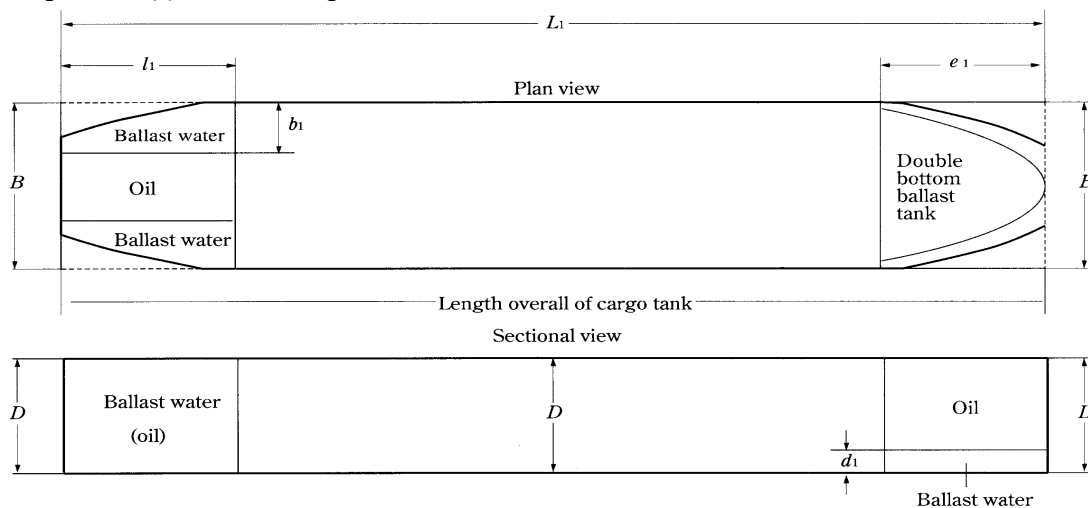

Notes:

Wing tank: $PAc = D \times l_t$ (for both sides)

$PAs = b_t \times l_t$ (for both sides)

Double bottom tank: $PAc = d_t \times l_{t1}$ (for each side)

$Pas = B \times l_{t1}$

Fig. 3.3.2-10(9) When there is a Suction Well in Double Bottom Tank or Double Bottom Space

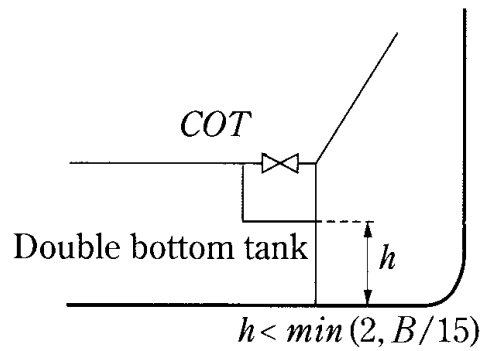

Note:

However, any suction well of a reasonable size with a depth not exceeding 1/2 of the height of double bottom tanks may not be taken into account. Namely, the suction well even as shown in this figure may be neglected.

Fig. 3.3.2-10(10) Inclusion of *PAs* when the Requirement for the Minimum Depth is Not Satisfied for the Entire Length of the Double Bottom Tank

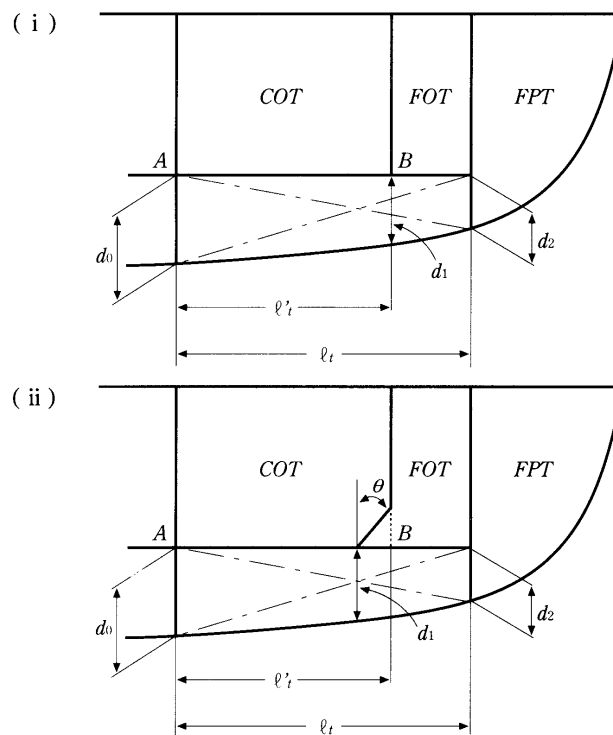

Note:

When d_1 satisfies the requirement, the double bottom space of AB (l_t) may be counted in *PAs*. In the case of arrangement as in (ii), the angle θ is to be equal to or less than 45 degrees.

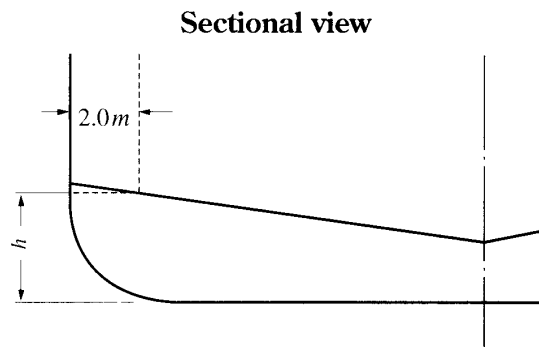
Fig. 3.3.2-10(11) Measurement of h in Calculating PAC of a Double Bottom Tank with Slanted Tank Top Plating (1)

Notes:

$$PAC = h \text{ (height of double bottom)} \times 2^*$$

*Including both sides

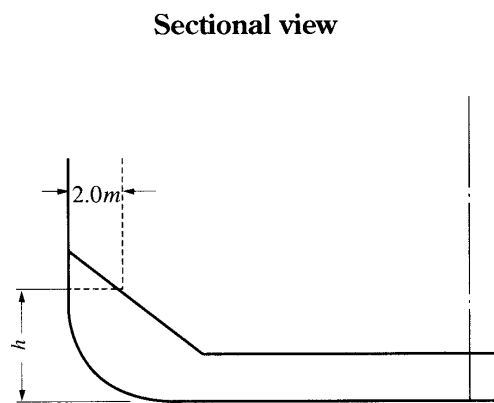
Fig. 3.3.2-10(12) Measurement of h in Calculating PAC of a Double Bottom Tank with Slanted Tank Top Plating (2)

Notes:

$$PAC = h \text{ (height of double bottom)} \times 2^*$$

*Including both sides

3.2.4 Prevention of Oil Pollution in the Event of Collision or Stranding

1 For the purpose of the provisions of **3.2.4 in Part 3 of the Rules**, oil tankers with independent tanks and carrying oil cargoes in such tanks only are considered as double-hull oil tankers, provided that they are designed and constructed to be such that the minimum distance between the cargo tank boundaries and ship bottom and side-shell plating comply with the provisions of **3.2.4 in Part 3 of the Rules**.

2 Where the ship's bottom line longitudinally slopes, the cargo tank boundary line prescribed in **3.2.4(2)(a) in Part 3 of the Rules** is to be as shown in **Fig.3.3.2-11** or above at each section under consideration.

3 The calculation of the aggregate capacity of tanks referred to **3.2.4(1)(a)iv) in Part 3 of the Rules** (hereinafter referred to as "the aggregate capacity of tanks") is subject to the followings.

- (1) The capacity of tanks, such as ballast tanks in way of engine room, which are not specified in **3.2.4(1)(a)iv) in Part 3 of the Rules** is excluded from the aggregate capacity of tanks.
- (2) Where the ballast tanks in way of the double hull are not located uniformly, the capacity of ballast tanks located inboard of the assumed double hull line, determined by assuming that the ballast tanks are located uniformly, is excluded from the aggregate capacity of tanks. (See **Fig. 3.3.2-12**)
- (3) Where all or part of spaces located in the double hull are used as void spaces, these capacity may be included in the aggregate capacity of tanks. (See **Fig. 3.3.2-13**)

Fig. 3.3.2-11
Sectional view

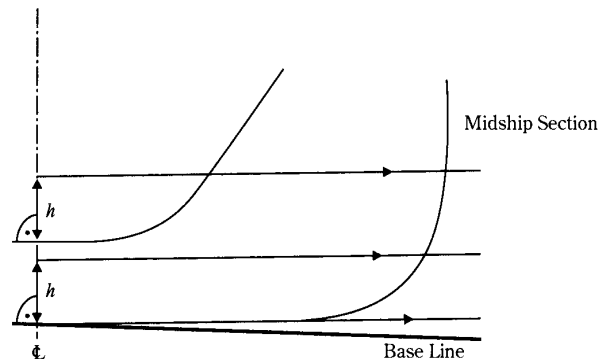
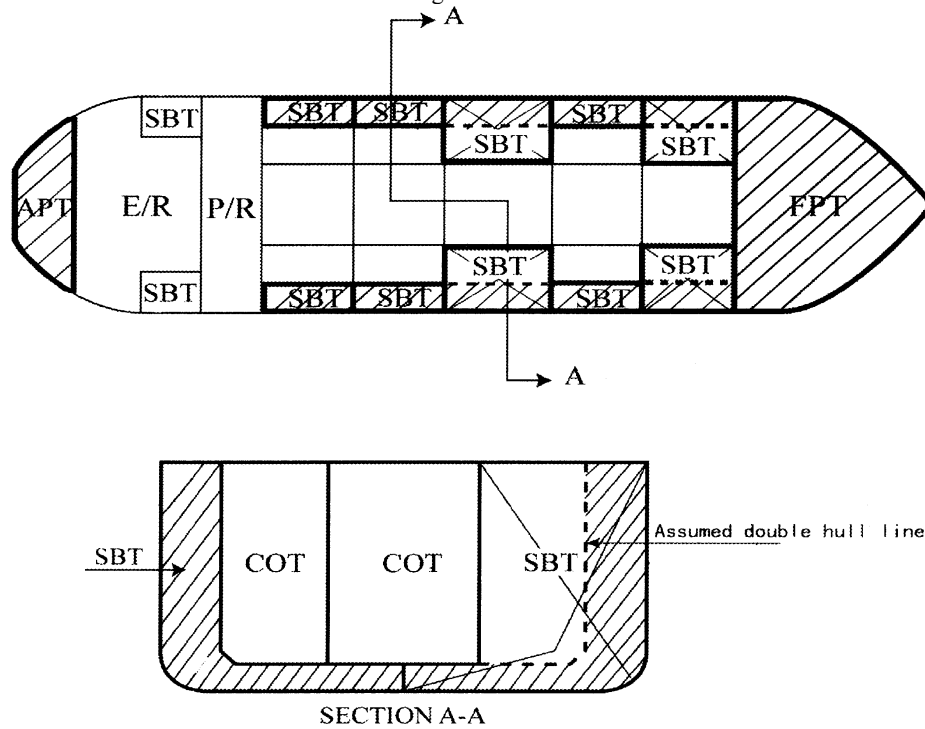

Fig. 3.3.2-12



Notes:

1. The hatched areas show the tank capable of being included in the aggregate capacity of tanks specified in [3.2.4\(1\)\(a\)iv](#) in Part 3 of the Rules.
2. "Assumed double hull line" show the line of assumed longitudinal bulkhead which connects continuously with the existing longitudinal bulkhead in the tank or space concerned, forward or afterword thereof. Where "assumed double hull line" is determined in the foremost or aftermost tank or space, it is assumed to connect continuously with the existing longitudinal bulkhead in the tank concerned, forward or afterword thereof, keeping the same distance between the longitudinal bulkhead and shell plating.

Fig. 3.3.2-13

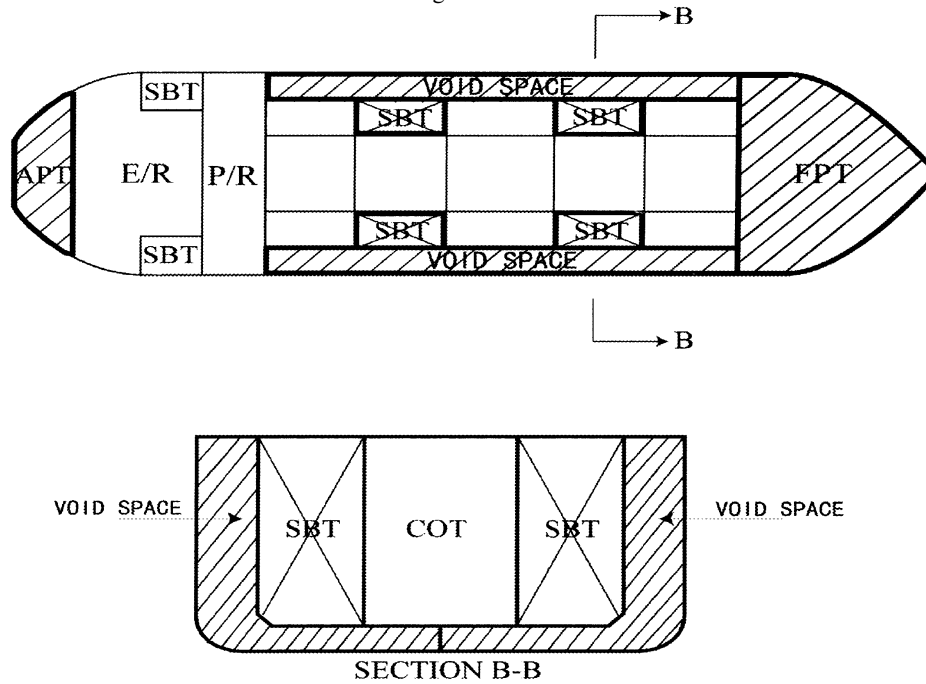

Note:

1. The hatched areas show the tank capable of being included in the aggregate capacity of tanks specified in [3.2.4\(1\)\(a\)iv](#) in Part 3 of the Rules.

3.2.5 Cargo Pump-room Protection

1 For the purpose of the provisions of [3.2.5 in Part 3 of the Rules](#), the double bottom protecting the cargo pump-room is to be a void or a ballast tank. In case where such tank location is complying with the provisions of [1.2.3 in Part 3 of the Rules](#), such double bottom may be a fuel oil tank.

2 With respect to the provisions of [3.2.5 in Part 3 of the Rules](#), ballast piping may be permitted to be located within the cargo pump-room double bottom provided any damage to that piping does not render the ship's pumps located in the cargo pump-room ineffective.

3 With respect to the provisions of [3.2.5-1 in Part 3 of the Rules](#), in cases where the distance between a portion of the cargo pump-room bottom plate and the ship's base line is less than the h specified in [3.2.5-1 in Part 3 of the Rules](#), only such portion of the pump-room may be protected by a double bottom construction.

3.3 Installations and Piping Arrangements

3.3.1 Installations for the Retention of Oil On Board

1 The wording "tanks with smooth wall surfaces" specified in [3.3.1-3\(3\) in Part 3 of the Rules](#) includes main cargo tanks of oil/bulk ore combination carriers built with short depth vertical frame members. Furthermore, vertical corrugated bulkhead walls are to be taken as smooth wall surfaces.

2 The wording "oil discharge monitoring and control system for ballast water approved by the Society" in [3.3.1-6 in Part 3 of the Rules](#) means to comply with the following standards and to have a copy of type approval certificate issued by the Society, the Administration or a competent organization.

- (1) For ships at beginning stage of construction on or after 1 January 2005: *IMO Res. MEPC.108(49)*
- (2) For ships intended to transport Bio-fuel blends containing 75% or more of petroleum oil at beginning stage of construction on or after 1 January 2005: *IMO Res. MEPC.240(65)*, unless instructed otherwise by the Administration
- (3) For other ships than above (1) and (2) at beginning stage of construction on or after 2 October 1986: *IMO Res. A.586(14)*
- (4) For other ships than above (1) to (3): *IMO Res. A.496(XII)* and *MEPC.13(19)*

3 The wording “provisions specified elsewhere” for the piping arrangements for the oil discharge monitoring and control system specified in **3.3.1-7 in Part 3 of the Rules** means those in the following (1) through (5):

- (1) The oily ballast discharge line is to be fitted with the sampling system complying with the followings:
 - (a) The system is to have a stop valve fitted adjacent to each sampling probe. Where the probe is mounted in cargo line, two stop valves are to be fitted, in series, in sample line. One of these may be the remote controlled sample selector valve.
 - (b) Sampling probes are to be arranged for easy withdrawal and are to as far as practicable be mounted at an accessible location in a vertical section of the discharge line. In case sampling probes are fitted in a horizontal section of the discharge line, these probes are to be fitted to the pipe which runs full of liquid at all times during the discharge of the effluent. Sampling probes are to normally penetrate inside the discharge pipe to a distance of one quarter the diameter of that pipe.
 - (c) Means are to be provided for cleaning the probes and piping system by the provision of permanent clean water flushing arrangements or equivalent method.
 - (d) The overall response time is to be as short as possible between an alteration in the mixture being pumped and the alteration in the meter reading and in any case not more than 40 *seconds*, including the response time of the meter.
 - (e) The flushing arrangement is to be such that where necessary it can be utilized for test-running and stabilizing the oil content meter and correcting for zero setting.
 - (f) A valve is to be provided for the manual collection of samples from the inlet piping to the meter at a point downstream of any sampling pump or at an equivalent location.
- (2) Sample water returning to the slop tank are not to be allowed to free-fall into the tank. In tankers equipped with an inert gas system a U-seal of adequate height is to be arranged in the piping leading to a slop tank.
- (3) A flow meter for measuring the rate of discharge is to be installed in a vertical section of a discharge line or in any other section of a discharge line as appropriate, so as to be always filled with the liquid being discharged.
- (4) A flow meter is to be suitable for the full range of flow rates that may be encountered during normal condition. Alternatively, arrangements such as the use of two flow meters of different ranges may be installed.
- (5) The visible and audible alarm devices specified in **3.3.1-6(4) in Part 3 of the Rules** are to be installed in the cargo control room. Where no cargo control room is provided, they are to be installed in a place manned at all times.

4 The wording “oil/water interface detector considered to appropriate by the Society” specified in **3.3.1-8, Part 3 of the Rules** means the oil/water interface detector complying with the resolution of *IMO MEPC. 5 (XIII)* which bears a stamp mark (or rubber stamp) proving that the item has passed the inspection by the Society and provided with a copy of type approval certificate issued by the Society.

5 The operation manual for the oil discharge monitoring and control system prescribed in **3.3.1-9 in Part 3 of the Rules** contain all the details necessary to operate and maintain the system and include at least the following information. The information may be grouped as indicated, or in an equivalent manner.

- Introduction : Particulars of the ship, together with the date on which the system was/is to be installed and index to remainder of manual. Text of Regulations 31 and 34 to be quoted in full.
- Section 1: Manufacturer's equipment manuals for major components of the system. These may include installation, commissioning, operating and fault finding procedures for the oil content monitor.
- Section 2: Operations manual comprising a description of the ship's cargo ballast systems, designated overboard discharges with sampling points, normal operational procedures, automatic inputs, manual inputs (as applicable), starting interlock and discharge valve control (as applicable), override system, audible and visual alarms, outputs recorded and, where required for manual input, flow rate when discharging by gravity and when pumping ballast overboard. It is also to include instructions for the discharge of oily water following mal-function of the equipment. The above information is supported by copies of relevant approved diagrams. Reference may be made to Section 1, where applicable.
- Section 3: Technical manual comprising fault finding schedules, maintenance record and electrical, pneumatic and hydraulic schematic diagrams and descriptions of the complete system. Reference may be made to Section 1, where applicable.
- Section 4: Test and check-out procedures to include a functional test at installation and guidance notes for the Surveyors

carrying out initial and in-service surveys. Reference may be made to Section 1, where applicable.

Appendix I: Technical installation specification including location and mounting of components, arrangements for maintaining integrity of 'safe' zones, safety requirements for electrical equipment installed in hazardous zones supported by copies of approved drawings, sample piping layout and sample delay calculations, design and arrangements of sampling probes, flushing arrangements and zero setting. Reference may be made to Section 1, where applicable.

Appendix II: Copy of Type Approval Certificate and Workshop Certificates for major components.

6 The wording "provided that the Society can afford such relaxation in consideration of the operating plan of ships" in **3.3.1-11 in Part 3 of the Rules** means as follows:

- (1) where ships are engaged in the limited voyages approved by the Administration and the period of each voyage is within 72 hours;
- (2) where reception facilities are sufficient for accepting the oily mixtures generated from voyages of the ship ; or
- (3) where discharges are transferred to reception facilities, and their records are noted in the Oil Record Book.

3.3.2 Discharge Arrangements

1 Relating to the requirements of **3.3.2-2 in Part 3 of the Rules**, the following are to be complied with:

- (1) Pipeline outlets for discharging the following effluent during a voyage of the ship is en route is, as a rule, to be led above the waterline:
 - (a) Dirty ballast water
 - i) Discharge water from slop tanks
 - ii) Additional ballast in bad weather, which is not clean
 - iii) Departure ballast of the ship with *COW* and load-on-top system
 - iv) Other discharge water with an oil content exceeding 15 ppm
 - (b) Segregated ballast water
 - (c) Clean ballast water
 - i) Arrival ballast of the ship with *COW* and the load-on-top system
 - ii) Ballast water other than segregated ballast with an oil content of 15 ppm or less
 - (d) Ballast water carried in clean ballast tanks
- (2) The piping for discharging into the sea at positions above the waterline is to be led to either of the following :
 - (a) The ship side discharge outlet located above the waterline in the ballast condition giving the deepest draught
 - (b) The fwd/aft cargo unloading arrangements above the upper deck.

Where midship discharge manifold or similar arrangements are provided, however, where the cargo manifold is used, an extension line is to be provided for this manifold, and means are to be provided so that the manifold can be effectively cleaned before discharging water ballast.
- (3) The ship side discharge outlet specified in the preceding **(2)(a)** is to be arranged so that the lower edge of the discharge outlet is not submerged in water when the maximum amount of ballast is loaded in a voyage in ballast. The discharge outlets located above the waterline in the following ballast condition is considered to comply with this requirement :
 - (a) For oil tankers not provided with segregated ballast tanks or clean ballast tanks, the ballast condition in which the ship carries the normal departure ballast and normal clean ballast at the same time.
 - (b) For oil tankers provided with segregated ballast tanks or clean ballast tanks, the ballast condition in which the ship carries ballast water in segregated ballast tanks or clean ballast tanks, and the ship carries the additional ballast complying with *Regulation 18 (3) of Annex I of the international convention for the prevention of pollution from ships as well in the cargo tanks.*
- (4) Notwithstanding the requirements in the preceding **(1)** to **(3)**, the pipings led to the ship side discharge outlet above the waterline under the departure ballast condition which is not a ballast condition giving the deepest draught may be accepted, provided that were installed before 1 January 1981.

2 The term "methods deemed appropriate by the Society" in **3.3.2-2(1) in Part 3 of the Rules** means the provisions of regulation D-1.1 of the *International Convention for the Control and Management of Ship's Ballast Water and Sediments*.

3 The wording "small diameter pipelines having the following sectional area and less are to be provided the shore transfer

manifold” specified in 3.3.2-4 in Part 3 of the Rules means that it is necessary to arrange piping so that drain from the cargo lines can be discharged ashore through the same discharge connection as used for the cargo main by closing the manifold valves (see Fig. 3.3.3-1).

Fig. 3.3.3-1 Connection between Manifold Valve and Small Diameter Line

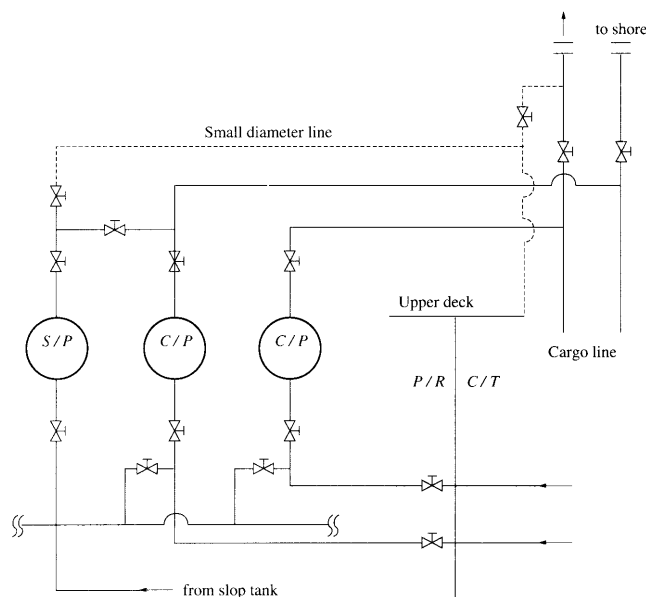

3.4 Crude Oil Washing System

3.4.2 Piping Arrangements for Crude Oil Washing System

For the purpose of the requirements of 3.4.2 in Part 3 of the Rules, the following requirements (1) through (7) are to be complied with:

- (1) For *COW* supply lines with a design pressure of 1.6MPa or less, gray cast iron valves complying with *JIS* or equivalent standards may be used.
- (2) Where wash water supply lines are connected to *COW* lines, spool pieces or rubber hoses and stop valves are to be provided at joints. However, the supply water for water washing is not to be led from the safety spaces such as machinery spaces. For example, even the piping arrangements as shown in Fig. 3.3.4-1 are not permitted.
- (3) As for such an arrangement may be regarded as the overpressure prevention system, provided that means are provided to stop the pump in case of overheating. Where crude oil is supplied by centrifugal pumps, of which the discharge pressures does not exceed the design pressure of the pipelines the overpressure prevention system for *COW* supply lines.
- (4) The types and arrangements of the shut-off devices for steam heating system, if provided, of *COW* lines (in common with crude and water washing) for hot water washing are to be in accordance with as shown in Fig. 3.3.4-2.

(5) Draining of washing crude oil supply lines

Drain from washing crude oil supply lines may be collected by gravitation through the inclination of piping or trim in a slop tank or tanks with branch connections. Sufficient consideration is to be given to the arrangement of stop valves for the washing crude oil supply main and branch lines, and the inclination of pipelines.

(6)

- (a) A slip-on joint complying with the requirements specified in 12.3.3 and 13.2.4, Part D of Rules for the Survey and Construction of Steel Ships may be used as the expansion joint of the *COW* system.
- (b) The remotest end of the washing crude oil supply main from the source of supply may be secured by placing a support base as shown in Fig. 3.3.4-3(1).
- (c) When the expansion joint is arranged as shown in Fig. 3.3.4-3(2), and the support base marked \triangle at the branch line is considered to be sufficient against the thrust acting caused by the supply main the pipe end arrangement on the supply

main, may be of an appropriate anchor system.

(d) In securing the washing crude supply branch pipe end with utilizing a crude washing machine, the procedure is to be as shown in **Fig. 3.3.4-3(3)**.

(7) The flexible hose specified in **3.4.2(2) in Part 3 of the Rules** is to meet the following requirements:

- (a) Hoses are to be of the types passing the following prototype tests **i)** through **v)** and to be designed with a breaking pressure of 5 times the rated maximum working pressure.
 - i) With the hose end fittings complete, a pressure corresponding to 5 times the rated maximum working pressure or more is to be applied.
 - ii) The temperature of the hose under the prototype test is to be carried out at the severest design temperature.
 - iii) Other tests as considered to be necessary depending on the type and service of the hose may be added.
 - iv) Any hose used for prototype tests is not to be used for ship's use.
 - v) Data showing the compatibility of hose materials and crude oil is to be submitted.
- (b) Each of the hoses that have passed the prototype tests in the preceding **(a)** is to be subjected to a hydrostatic test at shop at a pressure corresponding to 5 times the rated maximum working pressure or more of the hose and 2/5 of the design bursting pressure or less of the hose.
- (c) The rated maximum working pressure of a hose is not to be less than 0.0105MPa.

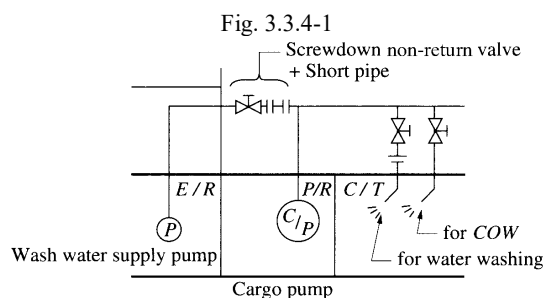
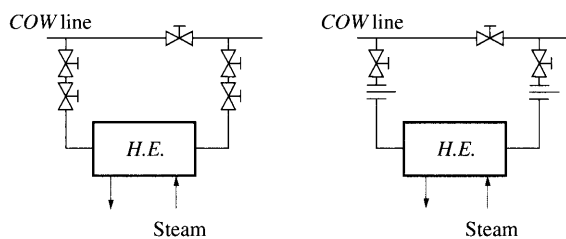
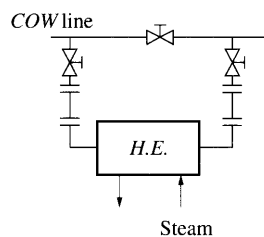

Fig. 3.3.4-2 Type and Arrangements of Shut-off Device

- (a) Double stop valves
- (b) Spectacle flanges + Stop valves



- (c) Short pipes + Stop valves



Remarks :

1. H.E. : Steam heater
2. In either case, the steam heater is to be provided in the cargo pump room or on the exposed deck. That is, the steam heater is not to be provided within the safety space.

Fig. 3.3.4-3(1)

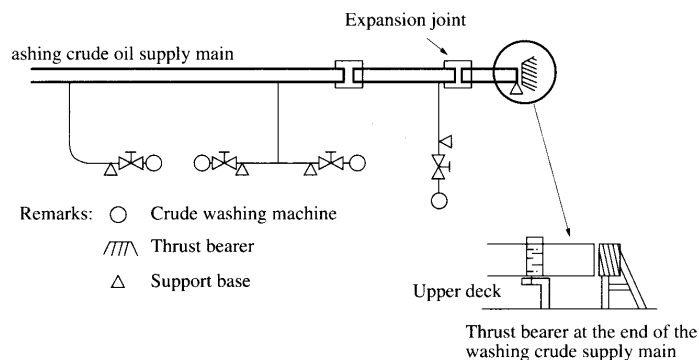

Fig. 3.3.4-3(2)

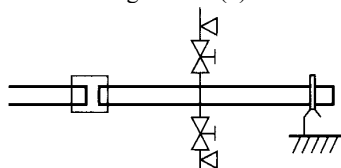
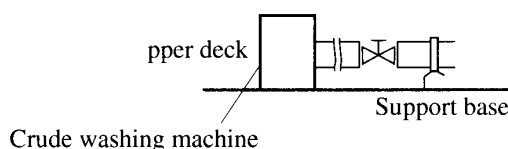

Fig. 3.3.4-3(3)



3.4.3 Crude Oil Washing Machines

1 The wording “considered to be appropriate by the Society” specified in 3.4.3(1) in Part 3 of the Rules means that the product bears a stamp mark (or rubber stamp) proving that the item has passed the inspection by the Society and is provided with a copy of type approval certificate issued by the Society.

2 The wording “the supporting method is to satisfy of the Society” specified in 3.4.3(3) in Part 3 of the Rules means that the products are to comply with the following requirements (1) through (4):

- (1) It is to be ensured that the natural frequency of the suspended portion from the fitted part of the washing machine to the washing machine does not resonate with the hull vibration.
- (2) For a crude washing machine with a single nozzle, the local strength of the part fitted to the hull is to be sufficient against the reaction of the washing machine.
- (3) The nozzle is to be effectively earthed to the hull.
- (4) The primary natural frequency (N) of the vibration system of a crude washing machine with one end fitted to the hull and another end free is to differ by at least 10% from the frequency of propeller vibration (F). In this case, the primary natural frequency and propeller vibration frequency are to be determined by the following formulae:

$$N = \frac{\lambda^2}{2\pi l^2} \sqrt{\frac{EI}{\gamma A}} \times \frac{1}{\sqrt{1 + \frac{140}{33} \cdot \frac{W}{w}}}$$

$$F = \frac{nF_0}{60}$$

where

$$\lambda = 1.875$$

l = suspended pipe length (cm)

E = modulus of longitudinal elasticity (N/cm^2)

I = moment of inertia of pipe (cm^4)

γ = density of pipe material (kg/cm^3)

A = sectional area of pipe (cm^2)

W = mass of pipe end washing machine (kg)

w = mass of suspended assembly (pipe and shaft) (kg)

n = number of propeller blades

F_0 = rotational speed of propeller (rpm)

3 For the purpose of the requirements of **3.4.3(6) in Part 3 of the Rules**, swash bulkheads in calculating projected areas is to be dealt with as follows:

- (1) The swash bulkhead may be dealt with as a tank wall, but in such a case, it is to be assumed that the bulkhead has no opening.
- (2) In cases other than the preceding (1), the effects of projection of the swash bulkhead and projections on the swash bulkhead are to be taken into account in calculations.

3.4.4 Pumps for Crude Oil Washing System

1 For the purpose of the requirements of **3.4.4(2)** and **3.4.4(3) in Part 3 of the Rules**, the number and capacity of pumps for supplying crude oil are to be in accordance with the following requirements:

- (1) Washing crude oil supply pumps (hereinafter referred to as "supply pumps") are to be arranged in such a way that at least two sets of pump can be operated in parallel.
- (2) When the number of supply pumps is two, each pump is to be capable of supplying 100% of the necessary amount of crude oil specified in the manual.
- (3) When the number of supply pumps is three, the arrangement is to be such that when one supply pump fails, the capacity of the rest of the pumps in parallel running is sufficient to supply 100% of the necessary amount of crude oil specified in the manual. When the capacity differs from pump to pump, the requirement is to be met even in the event of the failure of a pump with the greatest capacity.
- (4) When cargo discharging and crude oil washing are carried out by the same pump, the cargo discharge rate and crude oil supply rate used in calculating the preceding (2) and (3) are to be based on the values noted in the *COW* procedures and arrangements manual.
- (5) When the supply pumps are used for supplying crude oil for both the stripping eductor driving and crude oil washing, the sum of capacities necessary for supplying both purposes is to be 100% in calculations of the preceding (2) and (3).

2 For the purpose of the requirements of **3.4.4(4) in Part 3 of the Rules**, the requirements to have separate *COW* line systems capable of crude oil washing simultaneously for each tank of different types of cargo oils may not be to be complied with, even where two kind of crude oils are carried concurrently.

3.4.5 Stripping System

1 For the purpose of the requirements of **3.4.5(4) in Part 3 of the Rules**, it is required to provide liquid level gauges, and performance meters for hand sounding and stripping system for checking to see if the bottom of cargo tanks are dry, but where a closed liquid level gauge capable of accurately measuring liquid levels to the bottom surface (automatically closing type sounding pipes are not regarded as the closed liquid level gauge) is provided, the measuring hole for hand sounding may be omitted.

2 For the measuring hole for hand sounding specified in **3.4.5(4) in Part 3 of the Rules**, either of the following may be used:

- (1) Sounding pipe (automatic closing type)
- (2) Tank cleaning hatch

Where the tank cleaning hatches are used, it is recommended that a steel pipe or a pipe of equivalent material is provided on the hatch cover instead of opening the hatch itself for measuring and an automatic closing type pipe head assembly is fitted. A small-diameter hole (inside diameter: 35mm or less, may be used in common with density measuring) fitted with an oil-tight plug which cannot readily be opened may be provided. Or, a gas-control type measuring hole with a sectional area of the gas ejection opening of $10cm^2$ or less may serve the purpose.

- (3) Other openings considered to be appropriate by the Society.

3 For the purpose of the requirements of **3.4.5(4) in Part 3 of the Rules**, the number of measuring holes for hand sounding may be reduced to two for slop tanks, cargo tanks with a small capacity comparable to slop tanks and tanks with special bottom configurations as far as it is ascertainable that the tank bottom is dry.

4 For the purpose of the requirements of **3.4.5(7) in Part 3 of the Rules**, the means to ensure effective draining from tank internal

members may be by providing sufficient number and size of limber holes matching the suction capacity of the pump on bottom longitudinals and bottom transverses. When doubts arise, it is to be verified by stripping tanks filled with ballast water in real ships.

Chapter 4 TRANSITIONAL REQUIREMENTS

4.1 General

4.1.1 Application

1 The wording “oil tankers as deemed appropriate by the Society” specified in **4.1.1-4 in Part 3 of the Rules** means oil tankers:

- (1) which is engaged in voyages exclusively within an area under the jurisdiction of the Administration, or operated as a floating storage unit of heavy grade oil located within an area under the jurisdiction of the Administration, subject to the approval by the Administration; or
- (2) which is engaged in voyages exclusively within an area under the jurisdiction of another Administration, or operates as a floating storage unit of heavy grade oil located within an area under the jurisdiction of another Administration, provided that the another Administration within whose jurisdiction the oil tanker will be operating agrees to the operation of the oil tanker within an area under its jurisdiction.

4.1.2 Definitions

1 “Major conversion” defined in **4.1.2 in Part 3 of the Rules** means the following **(1)** through **(4)**:

- (1) Changes in *DWT* due to reassignment of Load Lines Unless structural changes are involved, such is not regarded as a major conversion. However, when the increase in *DWT* of a ship causes the application of new requirements in connection with the applicable group of *DWT*, the ship is to comply with the requirements on the basis of the date of construction of the ship.

Example 1) When *DWT* of an *EN* ship is changed from 68,000 to 70,000 *tonnes* due to reassignment of the Load Lines, the requirement of segregated ballast tanks becomes necessary.

Example 2) When *DWT* of an *EE* ship is changed from 39,000 to 40,000 *tonnes*, operation with a *COW* system becomes necessary.

Example 3) When *DWT* of an *EN* ship or an *EE* ship is changed from 40,000 to 39,000 *tonnes*, the requirements applicable to oil tankers with a *DWT* tonnage of 40,000 *tonnes* and over will no longer apply.

Example 4) Even if *DWT* of an *EN* ship is changed from 19,000 to 20,000 *tonnes*, the requirements of **3.2.3 in Part 3 of the Rules** do not apply.

- (2) Changes in ship type
 - (a) The change from an oil tanker to combination carrier is considered to be the change in ship type.
 - (b) The change from an *LPG* carrier to a combination carrier of *naphtha/LPG* is, as a rule, considered to be the change in ship type.
 - (c) The change from a crude oil carrier to a product carrier or vice versa is not considered to be the change in ship type.
- (3) Renewals of cargo tanks

An extensive renewal of cargo tanks is considered to be a major conversion.
- (4) Extension of hull
 - (a) An extensive extension is a major conversion.
 - (b) A minor extension without involving changes in the principal dimensions of a ship is to be judged for an increase in *DWT* case by case.
 - (c) When a new transverse section assembly is inserted to comply with the *SBT* requirements, such is not considered to be a major conversion, unless the cargo carrying capacity increases.
- (5) Hull downsizing

When a hull is downsized by partially removing cargo oil tanks, such is considered to be a major conversion including the conversion into an *SBT* tanker.

2 The following examples **(1)** through **(8)** are not considered to be a major conversion:

- (1) Conversions of main engines
- (2) Renewals of fore peak tanks, engine room, living quarters, etc. other than cargo oil tanks (when changes in principal dimensions are not involved)

- (3) Changes or renewals of outfits, piping arrangements, etc.
- (4) Damage repairs, ordinary renewals necessary for hull and maintenance, reconditioning work (when changes in principal dimensions are not involved)
- (5) Changes from *COW* ships to *SBT* ships or to *CBT* ships, or vice versa.
- (6) Changes from *CBT* ships to *SBT* ships.
- (7) Changes from ships built as an Ore/Oil carrier, an Oil/Bulk carrier, an Ore/Bulk/Oil carrier to ships not qualified as an oil tanker (excluding the case in which changes in hull structures are involved).
- (8) Conversion of an existing oil tanker to meet the requirements of **3.2.4** or **4.3.10 in Part 3 of the Rules**.

3 The wording “the method acceptable to the Society” specified in **4.1.2(6) in Part 3 of the Rules** may be in accordance with the requirements of “*American Society for Testing and Materials’ Standard Test Method (Designation D86)*”.

4 The wording “the specification acceptable to the Society” specified in **4.1.2(7) in Part 3 of the Rules** may be in accordance with the requirements of “*American Society for Testing and Materials’ Specification for Number Four Fuel Oil (Designation D396)*” or heavier.

4.3 Equipment for the Prevention of Pollution by Oil Carried in Bulk by Oil Tankers

4.3.4 Requirements for Oil Tankers Provided with Clean Ballast Tanks

1 The wording “the requirements as deemed to be appropriate by the Society” specified in **4.3.4-2 in Part 3 of the Rules** means the resolution of *IMO A.495 (XII)*.

2 The wording “the oil content meter deemed appropriate by the Society” specified in **4.3.4-3 in Part 3 of the Rules** means the product bearing a stamp mark (or rubber stamp) proving that the item has passed the inspection by the Society and is provided with a copy of type approval certificate showing the compliance with *IMO A.393 (X)*.

4.3.5 Oil Tankers Engaged In Specific Trades

The wording “the areas approved by the Society” specified in **4.3.5 in Part 3 of the Rules** means as follows:

- (1) Within ports or between terminals of a member state of *MARPOL 73/78*.
- (2) Within ports or between terminals of a member state of *MARPOL 73/78* meeting the following requirements:
 - (a) Voyages within special areas prescribed by the relevant law
 - (b) Voyages within restricted areas designated by the Administration

4.3.6 Oil Tankers Carrying Special Ballast

The wording “the case where the Society deemed appropriate” specified in **4.3.6 in Part 3 of the Rules** means that the requirements specified in (1) and (2) of Regulation 13D of *MARPOL 73/78* are complied with.

4.3.10 Prevention of Accidental Oil Pollution

1 The wording “the approval by the Society” specified in **4.3.10-1 and -3 in Part 3 of the Rules** means the approval by the Administration in accordance with the *Condition Assessment Scheme* adopted by the Maritime Environment Protection Committee by resolution *MEPC.94(46)*, as amended. (refer to **Appendix I** of this Guidance)

2 The wording “the conditions as deemed appropriate by the Society” specified in **4.3.10-2 in Part 3 of the Rules** means the approval by the Administration for continued operation of a Category 2 or 3 oil tanker fitted with only double bottoms or double sides not used for the carriage of oil and extending to the entire cargo tank length or double hull spaces which are not used for the carriage of oil and extend to the entire cargo tank length, but does not fulfill conditions for being exempted from the provisions of **4.1.1-3(2) in Part 3 of the Rules**, provided that:

- (a) The ship was in service on 1 July 2001;
- (b) The Administration is satisfied by verification of the official records that the ship complied with the conditions specified above;
- (c) The conditions of the ship specified above remain unchanged; and
- (d) Such continued operation does not go beyond the date on which the ship reaches 25 years after the date of its delivery.

3 Before applying for the following provisions, the ship’s owner/operator is to submit the statement of acknowledgment to the Society which a Party to the present Convention shall be entitled to deny entry into the ports or offshore terminals under its jurisdiction of oil tankers operating in accordance with the provisions.

- (a) **4.3.10-3 in Part 3 of the Rules**; or

(b) provisions of -2 above beyond the anniversary of the date of delivery of the ship in 2015

4.3.11 Prevention of Oil Pollution from Oil Tankers Carrying Heavy Grade Oil as Cargo

1 The wording “the conditions as deemed appropriate by the Society” specified in **4.3.11-1 in Part 3 of the Rules** means the approval by the Administration for continued operation of an oil tanker of 5,000 *tonnes* deadweight and above carrying heavy grade oil as cargo fitted with only double bottoms or double sides not used for the carriage of oil and extending to the entire cargo tank length or double hull spaces which are not used for the carriage of oil and extend to the entire cargo tank length, but does not fulfill conditions for being exempted from the provisions of **4.1.1-4 in Part 3 of the Rules**, provided that:

- (a) The ship was in service on 4 December 2003;
- (b) The Administration is satisfied by verification of the official records that the ship complied with the conditions specified above;
- (c) The conditions of the ship specified above remain unchanged; and
- (d) Such continued operation does not go beyond the date on which the ship reaches 25 *years* after the date of its delivery.

2 The wording “the approval by the Society” specified in **4.3.11-2 in Part 3 of the Rules** means the approval by the Administration if the ship is fit to continue operation, having regard to the size, age, operational area and structural conditions of the ship and provided that the operation is not go beyond the date on which the ship reaches 25 *years* after the date of its delivery. In that event, an oil tanker of 5,000 *tonnes* deadweight and above, carrying crude oil having a density at 15°C higher than 900 kg/m^3 but lower than 945 kg/m^3 , is to comply with the *Condition Assessment Scheme* specified in **4.3.10-1**.

3 Before applying for the -1 or -2 above, the ship’s owner/operator is to submit the statement of acknowledgment to the Society which a Party to the present Convention shall be entitled to deny entry of oil tankers operating in accordance with the provisions of the -1 or -2 above into the ports or offshore terminals under its jurisdiction, or deny ship-to-ship transfer of heavy grade oil in areas under its jurisdiction, except when this is necessary for the purpose of securing the safety of a ship or saving life at sea.

Part 4 CONSTRUCTION AND EQUIPMENT FOR THE PREVENTION OF POLLUTION BY DISCHARGES OF NOXIOUS LIQUID SUBSTANCES IN BULK

Chapter 2 CONSTRUCTION AND EQUIPMENT

2.2 Requirements for Installation of Construction and Equipment

2.2.1 Equipment for the Prevention of Discharge of Noxious Liquid Substances

1 The Manual for procedures and arrangements for discharge of noxious liquid substances in **2.2.1-5 in Part 4 of the Rules** shall have a standard format in compliance with Appendix 4 to Annex II. In the case of a ship engaged in international voyages on which the language used is not English, French or Spanish, the text shall include a translation into one of these languages.

2 The wording “the Guidelines developed by *IMO*” specified in **2.2.1-6 in Part 4 of the Rules** means the “*Guidelines for the Use of Electronic Record Books under MARPOL (IMO Res. MEPC.312(74))*”.

2.2.2 Requirements for Ships Carrying Category X Substances, Category Y Substances or Category Z Substances

In application of the requirements of **2.2.2 in Part 4 of the Rules**, if a ship is converted to such an extent as to affect main features relating to the requirements of 3.9(b), 4.9.2 and 4.11.2 in the Bulk Chemical Code on or after 1 October 2007 or a ship carries for the first time substances that come under the Bulk Chemical Code on or after 1 October 2007, application of the Bulk Chemical Code is to be in accordance with IACS Unified Interpretation CC1, CC2 and CC3.

Chapter 4 EQUIPMENT FOR THE PREVENTION OF DISCHARGE OF NOXIOUS LIQUID SUBSTANCES

4.2 Prewashing Systems

4.2.1 General

Prewashing systems in **4.2.1 in Part 4 of the Rules** are to be taken into account the Prewash Procedures in Appendix 6 to *Annex II*.

4.3 Stripping System

4.3.3 Blowing System

Where a blowing system is provided to enhance the ability of the stripping system, application for approval and tests are to be carried out together with the stripping system.

4.4 Discharge Arrangements below the Waterline

4.4.3 Size of Discharge Outlets

1 Where discharge outlets are fitted in the downstream direction, the diameter of the discharge outlets may be reduced to the following value:

$$D_0 = D \sin \theta$$

θ : angle between side shell and the discharge centre line

D : value specified in **4.4.3-1 in Part 4 of the Rules**

2 Where effective baffles are provided, the calculation formula in **4.4.3 in Part 4 of the Rules** may not be complied with.

4.7 Segregated Ballast Tanks

4.7.1 General

For existing ships of with length L_f of 50 m or less among ships not engaged in international voyages, the capacity of segregated ballast tanks may comply with the conditions specified in **Table 4.4.7-1** using the following conditions.

Moulded draught amidships $\geq 0.200 + 0.032 L_f$ (m)

Aft trim $\leq (0.024 - 6 \times 10^{-5} L_f) L_f$ (m)

Table 4.4.7-1 Capacity Requirements for Segregated Ballast Tanks

Case	Moulded draught amidships	Aft trim	Additional requirements
1	○	○	-
2	○	×	Fwd draught $> 0.025 L_f$
3	○	×	Fwd draught $\leq 0.025 L_f$ To comply with 10.6.2.4(1), Part 1, Part C of the Rules for the Survey and Construction of Steel Ships

(Remark)

○ : The relevant requirements are complied with.

× : The relevant requirements are not complied with.

Part 5 SHIPBOARD OIL POLLUTION EMERGENCY PLANS

Chapter 2 TECHNICAL REQUIREMENTS

2.2 Entries in Shipboard Oil Pollution Emergency Plans

2.2.1 Procedures to be Followed when Reporting an Oil Pollution Incident

1 Actual Discharge

Actual discharge of oil referred to in [2.2.1-1 in Part 5 of the Rules](#) means as follows:

- (1) a discharge of oil, resulting from damage to the ship or its equipment, or for the purpose of securing the safety of a ship or saving lives at sea; or
- (2) a discharge of oil during the operation of the ship in excess of the quantity or instantaneous rate of discharge permitted under the present International Convention for the Prevention of Pollution from Ships, 1973 as modified by the Protocol of 1978 relating thereto, as amended (*MARPOL 73/78*).

2 Probable Discharge

- (1) Probable discharge is to be determined by the master of the ship taking into account the following factors:
 - the nature of the damage, failure or breakdown of the ship, machinery or equipment;
 - ship location and proximity to land or other navigational hazards;
 - weather, tide, current and sea state; and
 - traffic density.
- (2) The master of the ship is to deal with the following cases as probable discharges taking the above into account:
 - damage, failure or breakdown which affects the safety of ships; examples of such situations are collision, grounding, fire, explosion, structural failure, flooding, cargo shifting; and
 - failure or breakdown of machinery or equipment which results in impairment of the safety of navigation; examples of such incidents are failure or breakdown of steering gear, propulsion, electrical generating system, essential ship-borne navigational aids.

2.2.2 List of Authorities or Persons to be Contacted in the Event of an Oil Pollution Incident

When compiling contact lists referred to in [2.2.2 in Part 5 of the Rules](#), due account is to be taken of the need to provide 24-hour contact information and to provide alternatives to the designated contact.

2.2.3 Actions to be Taken Immediately by Persons On Board the Ship to Reduce or Control the Discharge of Oil following the Incident

1 Differences in ship type, construction, cargo, equipment, manning, and even route may result in shifting emphasis being placed on various aspects of this section. The following are examples of incidents and casualties which should be considered:

- (1) Operational spills
 - (a) Pipe leakage
 - (b) Tank overflow
 - (c) Hull leakage
- (2) Spills resulting from casualties
 - (a) Grounding
 - (b) Fire/explosion
 - (c) Collision
 - (d) Hull failure
 - (e) Excessive list
 - (f) containment system failure

- (g) submerged/foundered
- (h) wrecked/stranded
- (i) hazardous vapor release

2 Procedures to be followed by the master and officers of the ship to mitigate or control the discharge of oil and precautions therefore are to be provided in the form of checklists which will ensure that they consider all appropriate factors, when addressing incidents or casualties.

2.3 Appendices to Shipboard Oil Pollution Emergency Plans

Lists, plans and drawings attached as Appendices are to be reviewed and updated at the responsibility of the owner/operator, charterer or manager.

Part 6 SHIPBOARD MARINE POLLUTION EMERGENCY PLAN FOR NOXIOUS LIQUID SUBSTANCES

Chapter 2 TECHNICAL REQUIREMENTS

2.2 Entries in Shipboard Marine Pollution Emergency Plan for Noxious Liquid Substances

2.2.1 Procedures to be Followed when Reporting a Noxious Liquid Substance Pollution Incident

1 Actual Discharge

Actual discharge of a noxious liquid substance referred to in [2.2.1-1 in Part 6 of the Rules](#) means as follows:

- (1) a discharge of a noxious liquid substance, resulting from damage to the ship or its equipment, or for the purpose of securing the safety of the ship or saving lives at sea; or
- (2) a discharge of a noxious liquid substance during the operation of the ship in excess of the quantity or instantaneous rate permitted under the present International Convention for the Prevention of Pollution from Ships, 1973 as modified by the Protocol of 1978 relating thereto, as amended (*MARPOL 73/78*).

2 Probable Discharge

- (1) Probable discharge is to be determined by the master of the ship taking into account the following factors:
 - the nature of the damage, failure or breakdown of the ship, machinery or equipment;
 - ship location and proximity to land or other navigational hazards;
 - weather, tide, current and sea state; and
 - traffic density.
- (2) The master of the ship is to deal with the following cases as probable discharges when taking the above into account:
 - damage, failure or breakdown which affects the safety of ships; examples of such situations are collision, grounding, fire, explosion, structural failure, flooding, cargo shifting; and
 - failure or breakdown of machinery or equipment which results in impairment of the safety of navigation; examples of such incidents are failure or breakdown of steering gear, propulsion, electrical generating system, essential ship-borne navigational aids.

2.2.2 List of Authorities or Persons to be Contacted in the Event of a Noxious Liquid Substance Pollution Incident

When compiling contact lists referred to in [2.2.2 in Part 6 of the Rules](#), due account is to be taken of the need to provide 24-hour contact information and to provide alternatives to the designated contact.

2.2.3 Actions to be Taken Immediately by Persons On Board the Ship to Reduce or Control the Discharge of Noxious Liquid Substance Following the Incident

1 Differences in ship type, construction, cargo, equipment, manning, and even route may result in shifting emphasis being placed on various aspects of this section. The following are examples of incidents and casualties which should be considered:

- (1) Operational spills
 - (a) Pipe leakage
 - (b) Tank overflow
 - (c) Hull leakage
- (2) Spills resulting from casualties
 - (a) Grounding
 - (b) Fire/explosion
 - (c) Collision
 - (d) Hull failure
 - (e) Excessive list

- (f) containment system failure
- (g) submerged/foundered
- (h) wrecked/stranded
- (i) hazardous vapor release
- (j) dangerous reactions of cargo
- (k) other dangerous cargo release
- (l) loss of tank environmental control
- (m) cargo contamination yielding a hazardous condition

2 Procedures to be followed by the master and officers of the ship to mitigate or control the discharge of a noxious liquid substance and precautions therefore are to be provided in the form of checklists which will ensure that they consider all appropriate factors, when addressing incidents or casualties.

2.3 Appendices to Shipboard Marine Pollution Emergency Plans for Noxious Liquid Substances

Lists, plans and drawings attached as Appendices are to be reviewed and updated at the responsibility of the owner/operator, charterer or manager.

Part 7 EQUIPMENT FOR THE PREVENTION OF POLLUTION BY SEWAGE

Chapter 2 EQUIPMENT FOR THE PREVENTION OF POLLUTION BY SEWAGE FROM SHIPS

2.2 Requirements for Installation of Equipment

2.2.1 Equipment for the Prevention of Pollution by Sewage

1 The “sewage treatment plant as deemed appropriate by the Society” referred to in **2.2.1(1)(a)i**, **Part 7 of the Rules** means one that satisfies the following:

- (1) It complies with one of the following **(a)** to **(c)** in addition to either being approved by the Society in accordance with **Chapter 8, Part 2 of the Guidance for the Approval and Type Approval of Materials and Equipment for Marine Use** or having passed an inspection by an organization authorized by the Administration or deemed appropriate by the Society.
 - (a) The requirements of *IMO Res. MEPC.227(64)* (excluding 4.2 of the Annex), as amended by *IMO Res. MEPC.284(70)*, for those which fall under the following **i)** or **ii)**:
 - i) installations on board ships at beginning stage of construction on or after 1 January 2016; or
 - ii) installations on ships at beginning stage of construction before 1 January 2016; with a contractual delivery date to the ship on or after 1 January 2016 or, in the absence of a contractual delivery date, the actual delivery date of the equipment to the ship on or after 1 January 2016.
 - (b) The requirements of *IMO Res. MEPC.159(55)* for those which do not fall under **i)** or **ii)** of **(a)** above but fall under the following **i)** or **ii)**:
 - i) installations on board ships at beginning stage of construction on or after 1 January 2010; or
 - ii) installations on ships at beginning stage of construction before 1 January 2010; with a contractual delivery date to the ship on or after 1 January 2010 or, in the absence of a contractual delivery date, the actual delivery date of the equipment to the ship on or after 1 January 2010.
 - (c) The requirements of *IMO Res. MEPC.2(VI)* for those which neither fall under **i)** or **ii)** of **(a)** above nor **i)** or **ii)** of **(b)** above.
- (2) It has sufficient capacity to treat that calculated by A and N_p in **-4** as a standard.

2 The wording “sewage comminuting and disinfecting system as deemed appropriate by the Society” referred to in **2.2.1(1)(a)ii**, **Part 7 of the Rules** means one that satisfies the following:

- (1) It is approved by the Society in accordance with **Chapter 8, Part 2 of the Guidance for the Approval and Type Approval of Materials and Equipment for Marine Use** or have passed an inspection by an organization authorized by the Administration or deemed appropriate by the Society.
- (2) It is to have a sufficient capacity to comminute and disinfect that calculated by A and N_p in the following **-4** as a standard.

3 The capacity of the “temporary storage of sewage” referred to in **2.2.1(1)(a)ii**, **Part 7 of the Rules** is to be in accordance with the requirements specified in **-4**. In this case, D_a may be taken as the maximum number of days operating in areas within 3 *nautical miles* from the territorial base line of any one state.

4 For the “capacity to the satisfaction of the Society” referred to in **2.2.1(1)(a)iii**, **Part 7 of the Rules**, the holding tank is to comply with the following formula:

$$C_T \geq AN_p D_a + R$$

Where

C_T : capacity of the holding tank (m^3)

A : 0.060 ($m^3/person/Day$)

the Society may approve to reduce the value of A by considering the flushing system etc.

N_p : the total number of persons on board

D_a : the maximum number of days operating in an area where the discharge of sewage which is not comminuted or disinfected into the sea is prohibited and, for passenger ships to which **2.2.1(1)(b), Part 7 of the Rules** applies, the special area (minimum 1 *day*)

R : initial flush water capacity necessary according to washing method, etc.

5 The “date determined by the *IMO*” referred to in **2.2.1(1)(b), Part 7 of the Rules** means, as long as *IMO Res. MEPC.275(69)* is valid, the following **(1)** to **(3)**:

- (1) 1 June 2019 for new passenger ships;
- (2) 1 June 2021 for existing passenger ships other than those specified in **(3)** below; and
- (3) 1 June 2023 for existing passenger ships en route directly to or from a port located outside the special area and to or from a port located east of longitude 28°10' E within the special area that do not make any other port calls within the special area.

6 The “sewage treatment plant as deemed appropriate by the Society” referred to in **2.2.1(1)(b)i, Part 7 of the Rules** means one that satisfies the following:

- (1) It complies with the requirements of *IMO Res. MEPC.227(64)* (including 4.2 of the Annex), as amended by *IMO Res. MEPC.284(70)*, in addition to either being approved by the Society in accordance with **Chapter 8, Part 2 of the Guidance for the Approval and Type Approval of Materials and Equipment for Marine Use** or having passed an inspection by an organization authorized by the Administration or deemed appropriate by the Society.
- (2) It has sufficient capacity to treat that calculated by A and N_p in **-4** above as a standard.

Part 8 EQUIPMENT FOR THE PREVENTION OF AIR POLLUTION FROM SHIPS

Chapter 1 GENERAL

1.1 General

1.1.1 General (Regulation 1 and 3 of Annex VI)

The wording “ships” in **1.1.1-1, Part 8 of the Rules** means a vessel of any type whatsoever operating in the marine environment and includes hydrofoil boats, air-cushion vehicles, submersibles, floating craft and fixed or floating platforms.

1.1.2 Terminology (Regulation 2, 13, 14 and 16 of Annex VI and 1.3, 4.1, 4.3.9 and 4.4.8 of *NOx Technical Code*)

1 In applying **1.1.2(1), Part 8 of the Rules**, *IMO* resolution *MEPC.291(71)* as amended is to be applied in case of diesel engines fitted with selective catalytic reduction systems. In applying the *IMO* resolution and the “*NOx Technical Code*”, the IACS MPC series unified interpretations (MPC30(Rev.1), MPC58(Rev.1), MPC59(Rev.1), MPC74(Rev.1), MPC77(Rev.1), MPC106, MPC112(Rev.1), MPC115(Rev.1), MPC116(Rev.1) and MPC125(Rev.1)) related thereto are also to be applied.

2 For the “Engine Family” and “Engine Group” referred to in **1.1.2(6) and (7), Part 8 of the Rules**, IACS Unified Interpretation MPC53(Rev.1) is also to be applied.

3 For the increase in “emission characteristics” and for the “substantial modification” referred to in **1.1.2(12)(b), Part 8 of the Rules**, IACS Unified Interpretation MPC32(Rev.1) is also to be applied.

4 The word “identical” in **1.1.2(13)(a), Part 8 of the Rules** means that for both the replacement diesel engine and the diesel engine being replaced the following items are the same:

- (1) Design and model;
- (2) Rated power;
- (3) Rated speed;
- (4) Use;
- (5) Number of cylinders;
- (6) Fuel system type (including injection control software, if applicable);
- (7) For diesel engines not certified to the standards set forth in **2.1.2-1, Part 8 of the Rules**, the NO_x critical components and settings (fuel pump model and injection timing, injection nozzle model, configuration, turbocharger model and auxiliary blower specification, cooling medium (seawater / freshwater), etc.); and
- (8) For diesel engines certified to the standards set forth in **2.1.2-1, Part 8 of the Rules**, the Engine Group or Engine Family to which these diesel engines belong.

5 For the requirements specified in **1.1.2(13)(c), Part 8 of the Rules**, the increase in output of diesel engines installed on ships at beginning stage of construction before 1 January 2000 is to be based on the maximum continuous output prior to 1 January 2000.

1.1.3 Equivalents (Regulation 4 of Annex VI)

The “alternative” specified in **1.1.3, Part 8 of the Rules** is to be obtained in accordance with any relevant guidelines developed by the *IMO* pertaining to the equivalent and to be approved by the Administration.

1.2 General Requirement

1.2.1 Ozone Depleting Substances (Regulation 12 of Annex VI)

1 Even for ships in which it is acceptable to install ozone depleting substances by **1.2.1, Part 8 of the Rules**, the requirement specified in **10.4.1-3, Part R of the Rules for the Survey and Construction of Steel Ships** is to be complied with.

2 In applying **1.2.1-6, Part 8 of the Rules**, with respect to the electronic record book used as an Ozone Depleting Substances

Record Book, reference is to be made to *IMO resolution MEPC.312(74)*.

1.2.2 Use and Carriage of Fuel Oil (Regulation 14 of Annex VI)

1 In applying **1.1.3, Part 8 of the Rules** and **-1** or **-2** of **1.2.2, Part 8 of the Rules**, in cases where an exhaust gas cleaning system is used as an “alternative” to the use of fuel oil whose sulphur content is equal to or below 0.50% *m/m* or 0.10% *m/m*, such an exhaust gas cleaning system is to comply with the requirements of *IMO resolution MEPC.340(77)* or others deemed appropriate by the Administration taking into account said resolution.

2 The requirement specified in **1.2.2-1, Part 8 of the Rules** also applies to fuel oils for emergency equipment.

1.2.3 Delivery of Fuel Oil and Bunker Delivery Notes (Regulation 18 of Annex VI)

1 Biofuel and synthetic fuel are to be dealt with in accordance with the following.

(1) The following apply according to the biofuel or synthetic fuel blending ratio.

(a) A fuel oil which is a blend of not more than 30 % by volume of biofuel or synthetic fuel is to satisfy **1.2.3-1(1), Part 8 of the Rules**.

(b) A fuel oil which is a blend of more than 30 % by volume of biofuel or synthetic fuel is to satisfy **1.2.3-1(2), Part 8 of the Rules**.

(2) The biofuels subject to above (1) include but are not limited to the following (a) to (f), which are fuel oils derived from biomass.

(a) Cooking Oils

(b) Fatty-Acid-Methyl-Esters (FAME)

(c) Fatty-Acid-Ethyl-Esters (FAEE)

(d) Straight Vegetable Oils (SVO)

(e) Hydrotreated Vegetable Oils (HVO)

(f) Glycerol or Other Biomass to Liquid (BTL)

(3) Synthetic fuel subject to above (1) is a fuel oil from synthetic or renewable sources similar in composition to petroleum distillate fuels.

(4) Bunker delivery notes are to include details as to whether or to what extent biofuels or synthetic fuel are blended.

2 Diesel engines certified in accordance with **2.1, Part 8 of the Rules** that can operate on biofuels or a synthetic fuel, or blends containing these fuels without changes to their NO_x critical components, settings and operating values other than values specified in an engine’s approved Technical File are permitted to use such fuel oils without having to undertake the assessments required by **1.2.3-1(2)(b), Part 8 of the Rules**. Furthermore, parent engine emissions tests undertaken for DM or RM grade fuels satisfying *ISO 8217:2005*, as required by paragraph 5.3.2 of the *NO_x Technical Code*, are valid for all DM or RM grade fuels used during operation, and engines may be specifically designed for or be capable of operating on such DM or RM grade fuels, including those meeting the successor standard to *ISO 8217:2005*.

3 The fuels specified in the following (1) may be regarded as complying with **1.2.3-1(2)(b), Part 8 of the Rules** and IAPP Certificates may continue to be issued upon verification that the NO_x emissions do not exceed specified limits by the method described in the following (2).

(1) Fuels falling under the any of the following.

(a) Fuel oils derived from methods other than petroleum refining.

(b) Fuel oils which are blends of more than 30 % by volume of biofuel or synthetic fuel and do not fall under **-2** above.

(c) Fuels for which NO_x emission limits have specified in accordance with **1.2.3-1(2)(b), Part 8 of the Rules** but for which such limits have not been certified through testing on test beds for either the engine group or engine family intended to use the fuel.

(2) When the fuels indicated in (1) above are burned in engines by one of the following methods, it is to be verified that the NO_x emissions do not exceed limits applicable to said engine. However, when undertaking measurements on board, an allowance of 10 % of the applicable limit may be accepted.

(a) Onboard simplified measurement method (6.3 of the *NO_x Technical Code*)

(b) Onboard direct measurement and monitoring method (6.4 of the *NO_x Technical Code*)

(c) Measurement procedures for emission verification on a test bed.

4 The “ship deemed necessary by the Society” referred to **1.2.3-2, Part 8 of the Rules** means all ships of 400 *gross tonnage* or above and, at the Administration’s discretion, ships of less than 400 *gross tonnage*.

5 The “bunker delivery note” required by **1.2.3-2, Part 8 of the Rules** is acceptable in either hard copy or electronic format. Such notes, however, are to contain at least the information specified in Appendix V to *Annex VI* and they are also to be retained and made available on board in accordance with **1.2.3-2, Part 8 of the Rules**. In addition, an electronic BDN is to be protected from edits, modifications or revisions, and authentication is to be possible by a verification method such as a tracking number, watermark, date and time stamp, QR code, GPS coordinates or other verification methods.

6 The wording “obtained in a way deemed appropriate by the Society” and “retained on board the ship in a way deemed appropriate by the Society” in **1.2.3-4, Part 8 of the Rules** mean that to be obtained in accordance with *IMO* resolution *MEPC.182(59)* and to be retained on board the ship in accordance with the resolution accompanied with the label of the sample required in the resolution respectively.

Chapter 2 EQUIPMENT FOR THE PREVENTION OF AIR POLLUTION FROM SHIPS

2.1 Nitrogen Oxides (NOx) (Regulation 13 of Annex VI)

2.1.1 General

1 In applying **2.1.1-1, Part 8 of the Rules**, the following (1) and (2) apply.

(1) In the case of engines intended to be operated normally in the gas mode, the limits specified in **Tables 8-1(a) to (c), Part 8 of the Rules** are to be met only for the gas fuel operation mode. Operation on pure liquid fuel resulting from restricted gas supply in cases of failures may be allowed for the voyage to the next appropriate port for the repair of the failure.

(2) The temporary exemption to emissions of nitrogen oxides exceeding the limits specified in **Table 8-1(c), Part 8 of the Rules** in a NOx emission control area applies in accordance with the following (a) and (b):

(a) With regard to the limits specified in **Table 8-1(c), Part 8 of the Rules** applied to emissions of nitrogen oxides from a diesel engine subject to **2.1.2-1(1)(c), Part 8 of the Rules**, a temporary exemption is granted for the time immediately following building and sea trials of a newly constructed ship, or before and following maintenance or repair of a diesel engine referred to in **2.1.2-1(1)(b), Part 8 of the Rules** or a dual fuel engine when the ship is required to not have gas fuel or gas cargo on board due to safety requirements, for which activities take place in a shipyard or other repair facility located in an applicable NOx emission control area provided that the following i) and ii) are met.

i) The engine meets the standards in **2.1.2-1(1)(b), Part 8 of the Rules**; and

ii) The following 1) to 3) are complied with.

1) The ship sails directly to or from the shipyard or other repair facility.

2) The ship does not load or unload cargo during the duration of the exemption.

3) The ship follows any additional specific routing requirements indicated by the port State in which the shipyard or other repair facility is located, if applicable.

(b) The temporary exemption specified in (a) above is granted only for the period specified in the following i) to iii):

i) For a newly constructed ship

The period beginning at the time the ship is delivered from the shipyard, including sea trials, and ending at the time the ship directly exits the NOx emission control area(s) or, with regard to a ship fitted with a dual fuel diesel engine, the ship directly exits the NOx emission control area(s) or proceeds directly to the nearest gas fuel bunkering facility appropriate to the ship located in the NOx emission control area(s).

ii) For a ship with a diesel engine complying with the standards in **2.1.2-1(1)(b), Part 8 of the Rules** undergoing conversion, maintenance or repair

The period beginning at the time the ship enters the NOx emission control area(s) and proceeds directly to the shipyard or other repair facility, and ending at the time the ship is released from the shipyard or other repair facility and directly exits the NOx emission control area(s) after performing sea trials, if applicable.

iii) For a ship with a dual fuel diesel engine undergoing conversion, maintenance or repair, when the ship is required to not have gas fuel or gas cargo on board due to safety requirements

The period beginning at the time the ship enters the NOx emission control area(s) or when it is degassed in the NOx emission control area(s) and proceeds directly to the shipyard or other repair facility, and ending at the time when the ship is released from the shipyard or other repair facility and directly exits the NOx emission control area(s) or proceeds directly to the nearest gas fuel bunkering facility appropriate to the ship located in the NOx emission control area(s).

2 The wording “engines intended for emergency services” referred to in **2.1.1-2(1), Part 8 of the Rules** does not include engines used also for non-emergency purpose such as engines to drive emergency generators used as described in **H3.3.1-1(5), Part H of the Guidance for the Survey and Construction of Steel Ships**.

3 The wording “waters deemed appropriate by the Society” in **2.1.1-2(2), Part 8 of the Rules** means waters subject to the

sovereignty or jurisdiction of the State the flag of which the ship is entitled to fly.

4 A “standard deemed appropriate by the Society” as specified in **2.1.1-5, Part 8 of the Rules** refers to the requirements of *IMO* resolution *MEPC.307(73)* or a standard deemed appropriate by the Administration taking into account this resolution.

2.1.2 Requirements for Installation

1 Major conversion of a diesel engine is to be accordance with following:

(1) The wording “time of the replacement or addition” of the diesel engine specified in **2.1.2-1(2), Part 8 of the Rules** means any of the date following (a) to (c):

- (a) The contractual delivery date of the engine to the ship. However, the engine is to be fitted on board and tested within six (6) months after the date specified in **2.1.2-1(1)(c)i) to iii), Part 8 of the Rules**, as appropriate.
- (b) In the absence of a contractual delivery date, the actual delivery date of the engine to the ship, provided that the date is confirmed by a delivery receipt. However, the engine is to be fitted on board and tested within six (6) months after the date specified in **2.1.2-1(1)(c)i) to iii), Part 8 of the Rules**, as appropriate.
- (c) In the event the engine is fitted on board and tested for its intended purpose on or after 6 months from the date specified in **2.1.2-1(1)(c)i) to iii), Part 8 of the Rules** as appropriate, the actual date that the engine is tested on board.

Entry of the date in (a) to (c) above, provided the conditions associated with those dates apply, is to be made in the item 8.a “Major conversion – According to Reg. 13.2.1.1 & 13.2.2” of the IAPP Certificate Supplement.

If the engine is not tested within six (6) months after the date specified in **2.1.2-1(1)(c)i) to iii), Part 8 of the Rules** as appropriate due to unforeseen circumstances beyond the control of the ship owner, then the provisions of “unforeseen delay in delivery” may be considered by the Administration in a manner similar to MARPOL Annex I UI6.

(2) The wording “guidelines established by the *IMO*” specified in **2.1.2-1(2), Part 8 of the Rules** means the “*2013 Guidelines as Required by Regulation 13.2.2 of MARPOL ANNEX VI in Respect of Non-Identical Replacement Engines not Required to Meet the Tier III Limit (IMO Res.MEPC.230(65), as amended)*”.

(3) Any substantial modification of a diesel engine or increasing of the maximum continuous rating of the engine by more than 10% compared to the maximum continuous rating of the original certification of the diesel engine is to be made in accordance with following (a) to (e):

- (a) For ships at beginning stage of construction prior to 1 January 2011
The diesel engine is to comply with the standard in **2.1.2-1(1)(a), Part 8 of the Rules**.
- (b) For ships at beginning stage of construction on or after 1 January 2011
The diesel engine is to comply with the standard in **2.1.2-1(1)(b), Part 8 of the Rules**.
- (c) For ships at beginning stage of construction on or after 1 January 2016 which operate in NOx emission control areas specified in (a) and (b) of **1.1.2(15), Part 8 of the Rules**
The diesel engine is to comply with the standard in **2.1.2-1(1)(c), Part 8 of the Rules**.
- (d) For ships at beginning stage of construction on or after 1 January 2021 which operate in NOx emission control areas specified in (c) and (d) of **1.1.2(15), Part 8 of the Rules**
The diesel engine is to comply with the standard in **2.1.2-1(1)(c), Part 8 of the Rules**.
- (e) For ships at beginning stage of construction on or after the date specified in **2.1.2-1(1)(c)iii), Part 8 of the Rules** which operate in NOx emission control areas other than those specified in (a) to (d) of **1.1.2(15), Part 8 of the Rules**
The diesel engine is to comply with the standard in **2.1.2-1(1)(c), Part 8 of the Rules**.

2 The wording “procedures specified otherwise by the Society” in **2.1.2-2(2), Part 8 of the Rules** means those listed below.

(1) Measurement procedures for emission verification on a test bed

The procedures are to be in accordance with Chapter 5 of the *NOx Technical Code*. In addition to Chapter 5, procedures for diesel engines fitted with selective catalytic reduction systems are to be in accordance with *IMO* resolution *MEPC.291(71)* as amended. In applying the resolution and the *NOx Technical Code* referred to in the resolution, IACS MPC series unified interpretations related thereto are also to be applied.

(2) On-board simplified measurement method

The method is to be in accordance with 6.3 of the *NOx Technical Code*.

(3) On-board direct measurement and monitoring method

The method is to be in accordance with 6.4 and Appendix VIII of the *NOx Technical Code*. Moreover, the following (a) to (g)

are to be complied with.

- (a) Data are to be taken within the last 30 *days* and in accordance with either the following **i)** or **ii)**:
 - i) Spot checks logged with other diesel engine operating data on a regular basis and over the full range of engine operation; or
 - ii) Results from continuous monitoring and data storage
- (b) These monitoring records are to be kept on board for 3 *months*.
- (c) Data are to be corrected for ambient conditions and fuel specification.
- (d) Measuring equipment is to be checked for correct calibration and operation, in accordance with the procedures specified in the engine's Technical File by the measurement equipment manufacturer.
- (e) Where exhaust gas after-treatment devices are fitted which influence the NO_x emissions, the measuring point(s) are to be located downstream of such devices.
- (f) Sufficient data is to be collected to calculate the weighted average NO_x emissions.
- (g) In case an exhaust gas cleaning system to reduce NO_x emissions is installed on the diesel engine, other relevant parameters may be monitored where approved by the Society.

3 The wording "fuel specified otherwise by the Society" in **2.1.2-2(3), Part 8 of the Rules** refers to a DM-grade marine fuel oil or RM-grade fuel oil (for the measurement procedures for emission verification on a test bed only in cases where a DM-grade fuel oil is not available) specified in *ISO 8217:2005*, or a gas fuel selected in accordance with the *NO_x Technical Code*.

2.1.3 Technical File and Record Book of Engine Parameters

1 The wording "on-board engine parameter check method otherwise specified by the Society" in **2.1.3-1(4), Part 8 of the Rules** means the method in accordance with 6.2 of the *NO_x Technical Code*.

2 For the "specifications" referred to in **2.1.3-1(7), Part 8 of the Rules**, IACS Unified Interpretation MPC45(Rev.1) is also to be applied.

3 The wording "Other information considered necessary by the Society" includes, but is not limited to, the following types of information:

- (1) If the engine has more than one mode of operation, details of the control guidelines for selecting the different modes of operation and recording the modes of operation, along with the method used for switching between modes.
- (2) Auxiliary control device (if applicable).
- (3) For engines fitted with selective catalytic reduction systems, the information specified in paragraph 3.2 of the Annex of *IMO resolution MEPC.291(71)*, as amended.

4 In applying **2.1.3-2, Part 8 of the Rules**, with respect to the electronic record book used as a Record Book of Engine Parameters, reference is to be made to *IMO resolution MEPC.312(74)*.

2.1.4 Recording of Information related to NO_x Emission Control

1 The wording "diesel engines installed on board a ship to which **2.1.2-1(1)(c)** applies" in **2.1.4, Part 8 of the Rules** includes additional or replaced diesel engines (refer to **2.1.2-1(1)**) installed on or after the relevant emission control area takes effect.

2 The wording diesel engines "which are certified to Tier II only" in **2.1.4, Part 8 of the Rules** means diesel engines which are certified to Tier II only and installed on board a ship which is constructed on or after the emission control area where the ship is operating takes effect.

3 In the context of the record keeping specified in **2.1.4, Part 8 of the Rules**, the diesel engines which are certified to Tier II only and installed on board a ship constructed before the entry into force of the emission control area where the ship is operating, are not considered to be diesel engines "which are certified to Tier II only" according to **2.1.4, Part 8 of the Rules**.

Such exclusion is extended to diesel engines which are certified to Tier II only replaced after the entry into force of the relevant emission control areas on board ships of this category, if the replacement engines meet the standards in **Table 8-1(b)** in accordance with **2.1.2-1(2), Part 8 of the Rules**.

4 In cases where a diesel engine installed on a ship constructed before the entry into force of the emission control area where the ship is operating has undergone a major conversion as described in **1.1.2(13)(a), Part 8 of the Rules**, such diesel engine is to be certified to Tier III; thus the requirement in **-1** applies.

5 The recording requirements in **2.1.4, Part 8 of the Rules** apply to diesel engines which are certified to Tier II only operation in a NO_x emission control area under the exemption according to **2.1.1-1(2)(a)**.

6 In applying **2.1.4, Part 8 of the Rules**, with respect to the electronic record book, reference is to be made to *IMO resolution MEPC.312(74)*.

2.2 Sulphur Oxides (SOx) and Particulate Matter (Regulation 14 of Annex VI)

2.2.1 Fuel Oil Change-over on Ship Operating in SOx Emission Control Areas

In applying **2.2.1-1, Part 8 of the Rules**, with respect to the electronic record book, reference is to be made to *IMO resolution MEPC.312(74)*.

2.2.2 In-use fuel oil sampling points

The wording “guidelines deemed appropriate by the Society” in **2.2.2-1, Part 8 of the Rules** means the “*2019 Guidelines for On Board Sampling for the Verification of the Sulphur Content of the Fuel Oil Used On Board Ships (MEPC.1/Circ.864/Rev.1, as amended)*”.

2.3 Vapour Collection System (Regulation 15 of Annex VI)

1 The wording “vapour collection system otherwise specified by the Society” in **2.3-1, Part 8 of the Rules** means a system which consists of those listed below, complies with the *MSC/Circ.585* and approved by the Society.

- (1) Vapour collection piping
- (2) Liquid level gauging device
- (3) High liquid level alarm
- (4) Venting system
- (5) Pressure gauges

2 The wording “VOC Management Plan approved by the Administration” in **2.3-3, Part 8 of the Rules** means to comply with *IMO resolution MEPC.185(59)* and to be approved by the Society or the Administration.

2.4 Incinerator (Regulation 16 of Annex VI)

1 The wording “incinerator installed on board a ship on or after 1 January 2000” in **2.4-1(2), Part 8 of the Rules** means, in case the incinerator is installed on board a ship which had been at beginning stage of construction before 1 January 2000, the incinerator of which the contractual delivery date to the shipyard or, in the absence of the contractual delivery date, the actual delivery date to the shipyard is before 1 January 2000.

2 The wording “waters deemed appropriate by the Society” in **2.4-1(2), Part 8 of the Rules** means waters subject to the sovereignty or jurisdiction of the State the flag of which the ship is entitled to fly.

3 The wording “to have construction deemed appropriate by the Society” in **2.4-1(2)(a), Part 8 of the Rules** means to comply with *IMO resolutions MEPC.76(40)* or *MEPC.244(66)* as may be amended and to have a copy of type approval certificate issued by the Society, the Administration or a competent organization.

4 With respect to the requirement of “waste is not to be fed into the unit” in **2.4-1(2)(c), Part 8 of the Rules** it is to be in accordance with the following (1) and (2):

- (1) For continuous-feed incinerators, solid waste is not to be fed into the unit when the combustion chamber flue gas outlet temperature is below 850 °C.
- (2) The sludge oil generated during normal operation of the ship is not to be regarded as waste in connection with this section, and can be fed into the unit when the required preheat temperature of 650 °C in the combustion chamber is achieved.

5 With respect to the requirement of “For batch-loaded incinerators, the unit is to be designed so that the combustion chamber gas outlet temperature is to reach 600 °C within 5 minutes after start-up” in **2.4-1(2)(d), Part 8 of the Rule**, the batch-loaded incinerator is to be designed so that the temperature in the actual combustion space where the solid waste is combusted reaches 600 °C within 5 minutes after start-up.

Chapter 3 ENERGY EFFICIENCY FOR SHIPS

3.1 General

3.1.1 Goal

The “Initial IMO Strategy” specified in **3.1.1, Part 8 of the Rules** refers to the *Initial IMO Strategy on Reduction of GHG Emissions from Ships (IMO Res. MEPC.304(72))*.

3.1.3 Application

The wording “where deemed appropriate by the Society” in **3.1.3-5, Part 8 of the Rules** means those cases where the ship is not normally engaged on international voyages but which, in exceptional circumstances, is required to undertake a single international voyage is exempted by the Administration from Chapter 4 of Annex VI.

3.1.4 Terminology (Regulation 2 of Annex VI)

1 In the case of the application of a major conversion specified in **3.1.4(16), Part 8 of the Rules**, the following are to apply, except in cases where specified by the Society or Administration:

- (1) “A conversion that substantially alters the dimensions, carrying capacity or engine power of the ship” specified in **3.1.4(16)(a), Part 8 of the Rules**; for example, it refers to (but is not limited to) change of length between perpendiculars (LPP), change of assigned freeboard, increase of assigned freeboard (excluding temporary increases), or increase of total engine power for propulsion by five percent or more.
- (2) The effect on attained EEDI as a result of any change of ship parameters, particularly any increase in total engine power for propulsion, is to be investigated.

2 “Reference lines” specified in **3.1.4(14), Part 8 of the Rules** refers to those calculated in accordance with the “2013 Guidelines for Calculation of Reference Lines for Use with the Energy Efficiency Design Index (EEDI)(IMO Res. MEPC.215(63), as amended)” as well as the “2013 Guidelines for Calculation of Reference Lines for Use with the Energy Efficiency Design Index (EEDI) for Cruise Passenger Ships Having Non-Conventional Propulsion (IMO Res. MEPC.233(65), as amended)”.

3 Ships dedicated to the carriage of fruit juice in refrigerated cargo tanks are to be categorized as the “refrigerated cargo carrier” referred to in **3.1.4(21), Part 8 of the Rules**.

3.2 Attained Energy Efficiency Design Index (Attained EEDI) (Regulation 22 of Annex VI)

1 The “guidelines deemed appropriate by the Society” specified in **3.2-1, Part 8 of the Rules** refers to the *2022 Guidelines on Survey and Certification of the Energy Efficiency Design Index (EEDI) (IMO Res. MEPC.365(79)) as amended* as well as IACS Procedural Requirement (PR) No. 38 “Procedure for calculation and verification of the Energy Efficiency Design Index (EEDI)”.

2 The “guidelines deemed appropriate by the Society” specified in **3.2-3, Part 8 of the Rules** refers to the *2022 Guidelines on the Method of Calculation of the Attained Energy Efficiency Design Index (EEDI) for New Ships (IMO Res. MEPC.364(79))* as well as IACS Procedural Requirement (PR) No. 38 “Procedure for calculation and verification of the Energy Efficiency Design Index (EEDI)”.

3.3 Attained Energy Efficiency Existing Ship Index (Attained EEXI) (Regulation 23 of Annex VI)

1 The “guidelines deemed appropriate by the Society” specified in **3.3-1, Part 8 of the Rules** refers to the *2022 Guidelines on Survey and Certification of the attained Energy Efficiency Existing Ship Index (EEXI) (IMO resolution MEPC.351(78))* as amended.

2 The “guidelines deemed appropriate by the Society” specified in **3.3-3, Part 8 of the Rules** refers to the *2022 Guidelines on the Method of Calculation of the Attained Energy Efficiency Existing Ship Index (EEXI)(IMO resolution MEPC.350(78))* as amended, and *Guidance on Methods, Procedures and Verification of in-service Performance Measurements(IMO MEPC.1/Circ.901)* as amended.

3 The “guidelines deemed appropriate by the Society” specified in **3.3-4, Part 8 of the Rules** refers to the *2021 Guidelines on the Shaft/Engine Power Limitation System to Comply with the EEXI Requirements and Use of a Power Reserve (IMO Res. MEPC.335(76))* as amended.

3.4 Required Energy Efficiency Design Index (Required EEDI) (Regulation 24 of Annex VI)

1 In **Table 8-8, Part 8 of the Rules**, a “ship corresponding to Phase 0” refers to the following new ships:

- (1) a ship for which the building contract is placed in Phase 0, and the delivery of which is before 1 January 2019; or
- (2) a ship for which the building contract is placed before 1 January 2013, and the delivery of which is on or after 1 July 2015 and before 1 January 2019; or
- (3) in the absence of a building contract, the ships referred to in the following **(a)** or **(b)**:
 - (a) a ship at beginning stage of construction on or after 1 July 2013 and before 1 July 2015, and the delivery of which is before 1 January 2019; or
 - (b) a ship at beginning stage of construction before 1 July 2013, and the delivery of which is on or after 1 July 2015 and before 1 January 2019.

2 In **Table 8-8, Part 8 of the Rules**, a “ship corresponding to Phase 1” refers to the following new ships:

- (1) a ship for which the building contract is placed in Phase 1, and the delivery of which is before 1 January 2024; or
- (2) a ship for which the building contract is placed before 1 January 2015, and the delivery of which is on or after 1 January 2019 and before 1 January 2024; or
- (3) in the absence of a building contract, the ship referred to in the following **(a)** or **(b)**:
 - (a) a ship at beginning stage of construction on or after 1 July 2015 and before 1 July 2020, and the delivery of which is before 1 January 2024; or
 - (b) a ship at beginning stage of construction before 1 July 2015, and the delivery of which is on or after 1 January 2019 and before 1 January 2024.

3 In **Table 8-8, Part 8 of the Rules**, a “ship corresponding to Phase 2” refers to the following new ships:

- (1) For ship types where Phase 2 ends on 31 March 2022:
 - (a) a ship for which the building contract is placed in Phase 2, and the delivery of which is before 1 April 2026; or
 - (b) a ship for which the building contract is placed before 1 January 2020, and the delivery of which is on or after 1 January 2024 and before 1 April 2026; or
 - (c) in the absence of a building contract, the ship referred to in the following **i)** or **ii)**:
 - i) a ship at beginning stage of construction on or after 1 July 2020 and before 1 October 2022, and the delivery of which is before 1 April 2026; or
 - ii) a ship at beginning stage of construction before 1 July 2020, and the delivery of which is on or after 1 January 2024 and before 1 April 2026.
- (2) For ship types where Phase 2 ends on 31 December 2024:
 - (a) a ship for which the building contract is placed in Phase 2, and the delivery of which is before 1 January 2029; or
 - (b) a ship for which the building contract is placed before 1 January 2020, and the delivery of which is on or after 1 January 2024 and before 1 January 2029; or
 - (c) in the absence of a building contract, the ship referred to in the following **i)** or **ii)**:
 - i) a ship at beginning stage of construction on or after 1 July 2020 and before 1 July 2025, and the delivery of which is before 1 January 2029; or
 - ii) a ship at beginning stage of construction before 1 July 2020, and the delivery of which is on or after 1 January 2024 and before 1 January 2029.

4 In **Table 8-8, Part 8 of the Rules**, a “ship corresponding to Phase 3” refers to the following new ships:

- (1) For ship types where Phase 3 commences with 1 April 2022 and onwards:
 - (a) a ship for which the building contract is placed in Phase 3; or
 - (b) a ship for which the building contract of which is placed before Phase 3, and the delivery is on or after 1 April 2026; or
 - (c) in the absence of a building contract, the ship referred to in the following **i)** or **ii)**:
 - i) a ship at beginning stage of construction on or after 1 October 2022; or
 - ii) a ship at beginning stage of construction before 1 October 2022, and the delivery of which is on or after 1 April 2026.
- (2) For ship types where Phase 3 commences with 1 January 2025 and onwards:
 - (a) a ship for which the building contract is placed in Phase 3; or

- (b) a ship for which the building contract of which is placed before Phase 3, and the delivery is on or after 1 January 2029; or
- (c) in the absence of a building contract, the ship referred to in the following i) or ii):
 - i) a ship at beginning stage of construction or after 1 July 2025; or
 - ii) a ship at beginning stage of construction before 1 July 2025, and the delivery of which is on or after 1 January 2029.

5 The “in cases where deemed appropriate by the Society” referred to in the note for **Table 8-9, Part 8 of the Rules** means those cases where the Administration allows the application of the amendment to Annex VI concerning new parameters for determination of reference values prior to 1 September 2019 based upon paragraph 4 of *IMO Res. 301(72)*.

6 The “guidelines deemed appropriate by the Society” specified in **3.4-4, Part 8 of the Rules** refers to the *2013 Interim Guidelines for Determining Minimum Propulsion Power to Maintain the Manoeuvrability of Ships in Adverse Conditions (IMO Res. MEPC.232(65))* as amended (consolidated text: *MEPC.1/Circ.850/Rev.2*) and the *Guidelines for Determining Minimum Propulsion Power to Maintain the Manoeuvrability of Ships in Adverse Conditions (MEPC.1/Circ.850/Rev.3)* as amended.

3.6 Ship Energy Efficiency Management Plan (SEEMP) (Regulation 26 of Annex VI)

1 The “gross tonnage” referred to in **3.6-2, Part 8 of the Rules** means the *gross tonnage* calculated in accordance with the *International Convention on Tonnage Measurements of Ships, 1969*.

2 The “guidelines deemed appropriate by the Society” specified in **3.6-3, Part 8 of the Rules** refers to the *2022 Guidelines for the Development of a Ship Energy Efficiency Management Plan (SEEMP) (IMO resolution MEPC.346(78))* as amended.

3 SEEMP is to be established in a working language or languages understood by ship's personnel.

4 The “guidelines developed by the IMO” specified in **3.6-4(3), Part 8 of the Rules** refers to the *Guidelines for the Verification and Company Audits by the Administration of Part III of the Ship Energy Efficiency Management Plan (SEEMP) (IMO resolution MEPC.347(78))* as amended.

5 For ships to which **3.6-4, Part 8 of the Rules** applies delivered on or after 1 January 2023, the starting year of the three-year implementation plan referred to in **3.6-4(1), Part 8 of the Rules** will be the year of delivery. If delivered on or after 1 October or later, the following year will then be the first year of the three-year implementation plan and an inferior rating (D or E) given for the remainder of the calendar year of delivery needs not to be counted in for the determination of whether the ship is to develop a Corrective Action Plan required by **3.6-4(2), Part 8 of the Rules**. Nothing in this interpretation relieves obligations of reporting data required by **3.8, Part 8 of the Rules** and reporting operational carbon intensity required by **3.9, Part 8 of the Rules**.

6 A ship to which **3.6-4, Part 8 of the Rules** applies changing company, or changing from one Administration to another and from one company to another concurrently, on or after 1 January 2023 are required to make a new SEEMP which includes the items indicated in **3.6-4, Part 8 of the Rules**. The year of change is to be the first year of the next three-year implementation plan.

7 In order to document how the required annual operational CII required by **3.9, Part 8 of the Rules** is to be achieved during the next three years, the items required by **3.6-4(1), Part 8 of the Rules** are to be a rolling three-year plan that begins the first year of the implementation plan and lasts for three years.

8 In the case of updating the items required by **3.6-4, Part 8 of the Rules**, the original three-year plan may remain.

3.8 Data Collection, Reporting and Retained related to Fuel Oil Consumption Reporting, etc. (Regulation 27 of Annex VI)

1 The data required to be collected and reported set forth in **3.8-1, Part 8 of the Rules** includes data relating to boil-off gas consumed on board for propulsion or operation (e.g. boil-off gas (BOG) used for propulsion, operational needs such as in a boiler, or burnt in a Gas Combustion Unit (GCU) for cargo tank pressure control or other operational purposes).

2 The “standardized format deemed appropriate by the Society” specified in **3.8-1(2)(a), Part 8 of the Rules** refers to the *2022 Guidelines for the Development of a Ship Energy Efficiency Management Plan (SEEMP) (IMO resolution MEPC.346(78))* as amended.

3 The “guidelines to be developed by the IMO” referred to in **3.8-1(3), Part 8 of the Rules** means the *2022 Guidelines for Administration Verification of Ship Fuel Oil Consumption Data and Operational Carbon Intensity (IMO resolution MEPC.348(78))* as amended.

4 The “data” specified in **3.8-2, Part 8 of the Rules** is not required to be maintained on board provided that the same data can be

made available by the company.

3.9 Operational Carbon Intensity (*Regulations 28 of Annex VI*)

3.9.1 Attained Annual Operational Carbon Intensity Indicator (Attained Annual Operational CII)

1 The “guidelines deemed appropriate by the *IMO*” specified in **3.9.1-1** and **3.9.1-3, Part 8 of the Rules** refers to the *2022 Guidelines on Operational Carbon Intensity Indicators and the Calculation Methods (CII Guidelines, G1)* (*IMO* resolution *MEPC.352(78)*) as amended and *2022 Interim Guidelines on Correction Factors and Voyage Adjustments For CII Calculations (CII Guidelines, G5)* (*IMO* resolution *MEPC.355(78)*) as amended.

2 The “standardized format developed by the *IMO*” specified in **3.9.1-2, Part 8 of the Rules** refers to the standardized format specified in *2022 Guidelines for the Development of a Ship Energy Efficiency Management Plan (SEEMP)* (*IMO* resolution *MEPC.346(78)*) as amended.

3.9.2 Required Annual Operational Carbon Intensity Indicator (Required Annual Operational CII)

The “guidelines deemed appropriate by the *IMO*” specified in **3.9.2-2, Part 8 of the Rules** refers to the *2022 Guidelines on the Reference Lines for Use with Operational Carbon Intensity Indicators (CII Reference Lines Guidelines, G2)* (*IMO* resolution *MEPC.353(78)*) as amended and *2021 Guidelines on the Operational Carbon Intensity Reduction Factors Relative to Reference Lines (CII Reduction Factors, G3)* (*IMO* resolution *MEPC.338(76)*) as amended.

3.9.3 Operational Carbon Intensity Rating

The “guidelines deemed appropriate by the *IMO*” specified in **3.9.3, Part 8 of the Rules** refers to the *2022 Guidelines on the Operational Carbon Intensity Rating of Ships (CII Rating Guidelines, G4)* (*IMO* resolution *MEPC.354(78)*) as amended and *2022 Guidelines for Administration Verification of Ship Fuel Oil Consumption Data and Operational Carbon Intensity* (*IMO* resolution *MEPC.348(78)*) as amended.

3.9.4 Corrective Actions

In case an inferior rating (i.e. rated as D for three consecutive years or rated as E) are given for data collected in a calendar year, the revised SEEMP, including the plan of corrective actions referred to in **3.9.4-1, Part 8 of the Rules**, is to be verified in the year following the year in which the data is collected, and it is to be developed to achieve the required annual operational CII by two years after the year in which the data is collected.

Part 9 CONSTRUCTION AND EQUIPMENT FOR THE PREVENTION FROM SHIPS OPERATING IN POLAR WATERS

Chapter 1 GENERAL

1.1 General

1.1.1 Application (Related to *Polar Code*, Part II-B, 1)

In applying **Chapter 2, Part 9 of the Rules**, the following (1) and (2) are to be applied.

- (1) It is recommended that the requirements of **1.2.5, Part 3 of the Rules** apply to ships when operating in Arctic waters.
- (2) Non-toxic biodegradable lubricants or water-based systems are to be considered in lubricated components located outside the underwater hull with direct seawater interfaces, like shaft seals and slewing seals.

Chapter 3 PREVENTION OF POLLUTION BY NOXIOUS LIQUID SUBSTANCES

3.2 Construction and Equipment

3.2.1 Type of Ships (Related to *Polar Code*, Part II-B, 2)

In applying **3.2.1, Part 9 of the Rules**, tanks containing products identified in **Table S17.1, Part S of the Rules for the Survey and Construction of Steel Ships**, column 'e', as type III ship or products identified in **Table S18.1, Part S of the Rules for the Survey and Construction of Steel Ships** are to be separated from the outer shell by a distance of not less than 760 mm.

Appendix I CONDITION ASSESSMENT SCHEME

**Resolution *MEPC.94(46)* adopted on 27 April 2001
and amended by resolutions *MEPC.99(48)* adopted on 11 October 2002,
MEPC.112(50) adopted on 4 December 2003,
MEPC.131(53) adopted on 22 July 2005,
MEPC.155(55) adopted on 13 October 2006
and *MEPC.236(65)* adopted on 17 May 2013**

1 Preamble

- 1.1 The Condition Assessment Scheme (CAS) is intended to complement the requirements of Annex B of the Guidelines on the enhanced programme of inspections during surveys of bulk carriers and oil tankers (hereinafter called Enhanced Survey Programme), adopted by the Assembly of the International Maritime Organization by resolution *A.744(18)*, as amended. The CAS is to verify that the structural condition of single hull oil tankers at the time of survey is acceptable and, provided subsequent periodical surveys are satisfactorily completed and effective maintenance is carried out by the ship's operator, will continue to be acceptable for a continued period of operation, as indicated in the Statement of Compliance, or Interim Statement of Compliance, as applicable.
- 1.2 The requirements of the CAS include enhanced and transparent verification of the reported structural condition and of the ship and verification that the documentary and survey procedures have been properly carried out and completed.
- 1.3 The Scheme requires that compliance with the CAS is assessed during the Enhanced Survey Programme of Inspections concurrent with intermediate or renewal surveys currently required by resolution *A.744(18)*, as amended.
- 1.4 The CAS does not specify structural standards in excess of the provisions of other International Maritime Organization conventions, codes and recommendations.
- 1.5 The CAS has been developed on the basis of the requirements of resolution *A.744(18)*, as amended, which were known* at the time of the adoption of the CAS. It is the intention to update the CAS as and when the need arises following amendments to resolution *A.744(18)*, as amended.
- * Assembly resolution *A.744(18)* as amended by resolution 2 of the 1997 *SOLAS* Conference, by resolution *MSC.49(66)* and by resolution *MSC.105(73)*.
- 1.6 The Assembly, at its twenty-seventh session, adopted the International Code on the enhanced programme of inspections during surveys of bulk carriers and oil tankers, 2011 (2011 *ESP* Code) (resolution *A.1049(27)*) and the Maritime Safety Committee, at its ninetieth session, adopted, by resolution *MSC.325(90)*, amendments to *SOLAS* regulation XI-1/2, replacing "resolution *A.744(18)*" with "2011 *ESP* Code" and thereby making the Code mandatory. Therefore, the references to "resolution *A.744(18)*" in the CAS are replaced by references to "the 2011 *ESP* Code (resolution *A.1049(27)*)".

2 Purpose

The purpose of the Condition Assessment Scheme is to provide an international standard to meet the requirements of regulations **20.6** and **20.7** and **21.6.1** of Annex I of the International Convention for the Prevention of Pollution from Ships, 1973, as modified by the Protocol of 1978 relating thereto, as amended.

3 Definitions

For the purpose of the CAS, unless expressly provided otherwise:

- 3.1 “*MARPOL 73/78*” means the Protocol of 1978 relating to the International Convention for the Prevention of Pollution from Ships, 1973, as amended.
- 3.2 “Regulation” means the regulations contained in Annex I of *MARPOL 73/78*.
- 3.3 “Recognized Organization (RO)” means an organization recognized by the Administration to perform the surveys in accordance with the provisions of regulation 6.3 of Annex I of *MARPOL 73/78*.*
* Under Regulation XI/1 of *SOLAS 74*, as amended, resolutions A.739(18) and A.789(19) are applicable to Recognized Organizations.
- 3.4 “Administration” means the Government of the State as defined in Article 2(5) of *MARPOL 73/78*.
- 3.5 “Category 2 oil tanker” means an oil tanker of 20,000 *tonnes* deadweight and above carrying crude oil, fuel oil, heavy diesel oil or lubricating oil as cargo, and of 30,000 *tonnes* deadweight and above carrying oil other than the above, which complies with the requirements for new oil tankers as defined in regulation 1.28.4 of Annex I of *MARPOL 73/78*.
- 3.6 “Category 3 oil tanker” means an oil tanker of 5,000 *tonnes* deadweight and above but less than that specified in regulation 20.3.1 or 20.3.2 of Annex I of *MARPOL 73/78*.
- 3.7 “Company” means the owner of the ship or any other organization or person such as the manager or the bareboat charterer, who has assumed the responsibility for the operation of the ship from the owner of the ship and who, on assuming such responsibility, has agreed to take over all duties and responsibilities imposed by the International Safety Management (ISM) Code.
- 3.8 “Substantial corrosion” means an extent of corrosion such that the assessment of the corrosion pattern indicates wastage in excess of 75% of the allowable margins, but within acceptable limits.
- 3.9 “GOOD condition” means a coating condition with only minor spot rusting.
- 3.10 “Thickness Measurement (TM) Firm” means a qualified company certified by a RO in accordance with the principles stipulated in Annex 7 of Annex B to the 2011 *ESP Code*, as amended.
- 3.11 “Critical Structural Areas” are locations which have been identified from calculations to require monitoring or from the service history of the subject ship or from similar or sister ships to be sensitive to cracking, buckling or corrosion which would impair the structural integrity of the ship.
- 3.12 “Suspect Areas” are locations showing substantial corrosion and/or are considered by the attending surveyor to be prone to rapid wastage.
- 3.13 “Organization” means the International Maritime Organization.

4 General Provisions

- 4.1 The Administration shall issue, or cause to be issued, detailed instructions to the RO which shall ensure that the CAS surveys are carried out in accordance with the provisions of sections 5 through 10 of this Scheme.
- 4.2 Nothing in this Scheme shall prevent an Administration from carrying out the CAS surveys itself, provided that such surveys are at least as effective as those prescribed in sections 5 through 10 in this Scheme.
- 4.3 The Administration shall require Category 2 and Category 3 oil tankers flying its flag which are subject to the provisions of regulation 20.7 to remain out of service during the periods referred to in paragraph 5.1.2, until these oil tankers are issued with a valid Statement of Compliance.

5 Application, Scope and Timing

5.1 Application

The requirements of the CAS apply to:

- .1 Oil tankers of 5,000 *tonnes* deadweight and above and of 15 *years* and over after date of delivery of the ship, in accordance with regulation 20.6;
- .2 Oil tankers subject to the provisions of regulation 20.7, where authorization is requested for continued service beyond the anniversary of the date of delivery of the ship in 2010; and
- .3 Oil tankers of 5,000 *tonnes* deadweight and above and of 15 *years* and over after date of delivery of the ship, carrying

crude oil as cargo having a density at 15°C higher than 900 kg/m³ but lower than 945 kg/m³, in accordance with regulation **21.6.1**.

5.2 Scope of the CAS

The CAS shall apply to surveys of the hull structure in way of cargo tanks, pump rooms, cofferdams, pipe tunnels, void spaces within the cargo area and all ballast tanks.

5.3 Timing

- 5.3.1 The CAS survey shall be aligned to the Enhanced Programme of Inspection.
- 5.3.2 The first CAS survey in accordance with regulation **20.6** shall be carried out concurrent with the first scheduled intermediate or renewal survey after 5 April 2005, or when the ship reaches the 15 *years* of age, whichever occurs later.
- 5.3.3 The first CAS survey in accordance with regulation **20.7** shall be carried out concurrent with the scheduled intermediate or renewal survey due prior to the anniversary of the date of delivery of the ship in 2010.
- 5.3.4 The first CAS survey in accordance with regulation **21.6.1** shall be carried out concurrent with the first scheduled intermediate or renewal survey after 5 April 2005.
- 5.3.5 In the case where the Statement of Compliance issued following the first CAS survey under **5.3.2** is valid beyond the anniversary of the date of delivery of the ship in 2010, that CAS may be treated as the first CAS carried out in compliance with regulation **20.7**.
- 5.3.6 Any subsequent CAS survey, required for the renewal of the Statement of Compliance, shall be carried out at intervals not exceeding 5 *years* and 6 *months*.
- 5.3.7 Notwithstanding the above, the Company may, with the agreement of the Administration, opt to carry out the CAS survey at a date earlier than the due date of the survey referred to above, provided that all the requirements of the CAS are complied with.

6 Survey Planning Requirements

6.1 Preparations for the CAS survey

6.1.1 General procedures

- 6.1.1.1 Early and detailed planning to identify areas of potential risk is a prerequisite for the successful and timely completion of the CAS. The following sequence of events shall be observed.
- 6.1.1.2 Notification from the Company to the Administration and to the RO of its intention to proceed with the CAS shall be submitted not less than 8 *months* prior to the planned commencement of the CAS survey.
- 6.1.1.3 Upon receipt of such notification the RO is to do the following:
 - .1 issue to the Company the Survey Planning Questionnaire (**Survey Programme and Survey Planning Questionnaire for OT and CT**) not later than 7 *months* prior to the planned commencement of the CAS survey; and
 - .2 advise the Company whether there have been any changes to the maximum acceptable structural corrosion diminution levels applicable to the ship.
- 6.1.1.4 The Company shall complete and return the Survey Planning Questionnaire to the RO not less than 5 *months* prior to the planned commencement of the CAS survey. A copy of the completed questionnaire shall be forwarded by the Company to the Administration.
- 6.1.1.5 The Survey Plan for the CAS shall be completed and submitted in signed order by the Company to the RO not less than 2 *months* prior to the planned commencement of the CAS survey. A copy of the Survey Plan for the CAS shall be forwarded by the Company to the Administration.
- 6.1.1.6 In special circumstances, such as re-activation from lay-up or unexpected events such as an extended stoppage period for hull or machinery damage, the Administration may, on a case by case basis, relax the time frame, outlined in **6.1.1.2** to **6.1.1.5**, for commencement of CAS procedures.
- 6.1.1.7 Such relaxation shall, at all times, be subject to the RO having sufficient time to complete the CAS survey and issue the Interim Statement of Compliance under regulation **20.6** or **21.6.1**, or the Administration to review the CAS Final Report and issue the Statement of Compliance under regulation **20.7**, as applicable,

prior to re-entry of the ship to service.

6.1.2 Survey Plan for the CAS

6.1.2.1 The Survey Plan for the CAS shall be developed by the Company in cooperation with the RO. The Administration may participate in the development of the Survey Plan, if it deems necessary. The RO shall be fully satisfied that the Survey Plan complies with the requirements of 6.2.2 prior to the CAS survey being commenced. The CAS survey shall not commence unless and until the Survey Plan has been agreed.

6.1.2.2 The Survey Planning Questionnaire is to be drawn up based on **Survey Programme and Survey Planning Questionnaire for OT and CT**.

6.2 Survey Plan documentation

6.2.1 In developing the Survey Plan, the following documentation shall be collected and reviewed with a view to identifying tanks, areas and structural elements to be examined:

- .1 basic ship information and survey status;
- .2 main structural plans of cargo and ballast tanks (scantling drawings), including information regarding use of high tensile steels (HTS);
- .3 Condition Evaluation Report, according to Annex 9 of Annex B of the 2011 *ESP* Code, as amended, and, where relevant, any previous CAS Final Reports;
- .4 thickness measurement reports;
- .5 relevant previous damage and repair history;
- .6 relevant previous survey and inspection reports from both the RO and the Company;
- .7 cargo and ballast history for the last 3 *years*, including carriage of cargo under heated conditions;
- .8 details of the inert gas plant and tank cleaning procedures as indicated in the Survey Planning Questionnaire;
- .9 information and other relevant data regarding conversion or modification of the ship's cargo and ballast tanks since the time of construction;
- .10 description and history of the coating and corrosion protection system (including anodes and previous class notations), if any;
- .11 inspections by the Company's personnel during the last 3 *years* with reference to:
 - .1 structural deterioration in general;
 - .2 leakages in tank boundaries and piping;
 - .3 condition of the coating and corrosion protection system (including anodes), if any;
- .12 information regarding the relevant maintenance level during operation including:
 - .1 port State control reports of inspection containing hull related deficiencies;
 - .2 Safety Management System non-conformities relating to hull maintenance, including the associated corrective action(s); and
- .13 any other information that will help identify Suspect Areas and Critical Structural Areas.

6.2.2 The Survey Plan shall include relevant information so as to enable the successful and efficient execution of the CAS survey and shall set out the requirements with respect to close-up surveys and thickness measurements. The Survey Plan shall include:

- .1 basic ship information and particulars;
- .2 main structural plans of cargo and ballast tanks (scantling drawings), including information regarding use of high tensile steels (HTS);
- .3 arrangement of tanks;
- .4 list of tanks with information on their use, extent of coatings and corrosion protection systems;
- .5 conditions for survey (e.g. information regarding tank cleaning, gas freeing, ventilation, lighting, etc.);
- .6 provisions and methods for access to structures;
- .7 equipment for surveys;
- .8 identification of tanks and areas for the close-up survey;
- .9 identification of tanks for tank testing, as per Annex 3 of Annex B of the 2011 *ESP* Code, as amended;
- .10 identification of areas and sections for thickness measurement;

- .11 identification of the Thickness Measurement (TM) firm;
- .12 damage experience related to the ship in question; and
- .13 Critical Structural Areas and Suspect Areas, where relevant.

6.2.3 The Survey Plan is to be developed using the Model Survey Plan for CAS set out in Appendix 2.

6.3 Documentation on board

- 6.3.1 The Company shall ensure that, in addition to the agreed Survey Plan, all other documents used in the development of the Survey Plan referred to in **6.2.1** are available on board at the time of the CAS survey.
- 6.3.2 Prior to the commencement of any part of the CAS survey, the attending surveyor(s) shall examine and ascertain the completeness of the on board documentation and shall review its contents with a view to ensuring that the Survey Plan remains relevant.

6.4 Conduct of CAS Surveys

- 6.4.1 The condition for CAS Survey, the conditions and method of access to the structures, the requirement for CAS Survey and the communication arrangements implemented during the CAS Survey are to meet the Mandatory Requirements for the Safe Conduct of CAS Surveys set out in Appendix 3.

7 CAS Survey Requirements

7.1 General

- 7.1.1 Prior to the commencement of any part of the CAS survey a meeting shall be held between the attending surveyor(s), the Company's representative(s) in attendance, the TM Firm Operator (as applicable) and the master of the ship for the purpose of ascertaining that all the arrangements envisaged in the Survey Plan are in place, so as to ensure the safe and efficient execution of the survey work to be carried out.
- 7.1.2 The CAS survey shall be carried out by not less than two qualified exclusive surveyors of the RO. A qualified surveyor of the RO shall attend on board during the taking of the thickness measurements for the purpose of controlling the process.
- 7.1.3 The RO shall designate the surveyor(s) and any other personnel who will be engaged in the CAS of each vessel and shall keep records to this end. A qualified surveyor(s) shall have documented experience in carrying out intermediate or renewal surveys in accordance with the Enhanced Survey Programme of Inspection for tankers. In addition, all RO personnel to be assigned duties in connection with the CAS shall complete, prior to the assignment of such duties, an appropriate training and familiarization programme to enable the RO to ensure the consistent and uniform application of the CAS. The Administration shall require the RO to keep records of the qualifications and experience of the surveyors and of other personnel assigned to carry out work for the CAS. The Administration shall require the RO to monitor the performance of the personnel who have carried out or have been engaged in any CAS work and to keep records to this end.
- 7.1.4 When the CAS survey is split between survey stations, a list of the items examined and an indication of whether the CAS survey has been completed shall be made available to the attending surveyors at the next survey station prior to continuing the CAS survey.
- 7.1.5 Whenever the attending surveyors are of the opinion that repairs are required, each item to be repaired shall be identified in a numbered list. Whenever repairs are carried out, details of the repairs effected shall be reported by making specific reference to relevant items in the numbered list.
- 7.1.6 Whenever the attending surveyors are of the opinion that it is acceptable to defer hull repairs beyond the due date previously assigned, such a decision shall not be left to the sole discretion of the attending surveyors. The RO Headquarters shall be consulted in such circumstances and shall give specific approval to the recommended action.
- 7.1.7 The CAS survey is not complete unless all conditions of class which relate to hull structures under review by the CAS survey have been rectified to the satisfaction of the RO.

7.2 Extent of overall and close-up surveys

7.2.1 Overall survey

An overall survey of all spaces set out in **5.2** shall be carried out at the CAS survey.

7.2.2 Close-up survey

The requirements for close-up surveys at the CAS survey are set out in **Table 7.2.2**.

7.2.3 The attending surveyors may extend the scope of the close-up survey as considered necessary, taking into account the Survey Plan, the condition of the spaces under survey, the condition of the corrosion prevention system and also the following:

- .1 any information that may be available on Critical Structural Areas;
- .2 tanks which have structures with reduced scantlings in association with a corrosion prevention system approved by the RO.

7.2.4 For areas in tanks where coatings are found to be in GOOD condition, the extent of close-up surveys according to **7.2.2** may be specially considered by the RO. However, sufficient close-up surveys shall be carried out, in all cases, to confirm the actual average condition of the structure and to note the maximum observed diminution of the structure.

7.3 Extent of thickness measurements

7.3.1 The thickness measurements shall be recorded using the tables contained in Appendix 2 of Annex 10 of Annex B of the 2011 *ESP* Code, as amended. It is recommended that these records be kept in an electronic medium.

7.3.2 The thickness measurements shall be carried out either prior to or, to the maximum extent possible, concurrently with the close-up survey.

7.3.3 The minimum requirements for thickness measurements for the CAS surveys shall be those set out in **Table 7.3.3**:

7.3.4 Where substantial corrosion is found, the extent of the thickness measurements shall be increased in accordance with Annex 4 of Annex B of the 2011 *ESP* Code, as amended.

7.3.5 In addition, the thickness measurements may be extended as considered necessary by the attending surveyors.

7.3.6 For areas in tanks where coatings are found to be in GOOD condition, the extent of thickness measurements, according to paragraph **7.3.3**, may be specially considered by the RO. However, sufficient thickness measurements shall be taken, in all cases, to confirm the actual average condition and the maximum observed diminution of the structure.

7.3.7 The thickness measurement to be taken shall be sufficient to enable the reserve strength calculations in accordance with Annex 12 of Annex B of the 2011 *ESP* Code, as amended.

7.3.8 Transverse sections shall be chosen where the maximum diminutions are expected to occur or are revealed from deck plating thickness measurements. At least one transverse section shall include a ballast tank within 0.5L amidships.

Table 7.2.2

Close up Survey Requirements
All web frame rings, in all ballast tanks (see note 1)
All web frame rings, in a cargo wing tank (see note 1)
A minimum of 30% of all web frame rings, in each remaining cargo wing tank (see note 1 and 3)
All transverse bulkheads, in all cargo and ballast tanks (see note 2)
A minimum of 30% of deck and bottom transverses including adjacent structural members, in each cargo centre tank (see note 3)
Additional complete transverse web frame rings or deck and bottom transverse including adjacent structural members as considered necessary by the attending surveyor

Notes:

- 1 Complete transverse web frame ring including adjacent structural members.
- 2 Complete transverse bulkhead, including girder and stiffener systems and adjacent members.
- 3 The 30% shall be rounded up to the next whole integer.

Table 7.3.3

Thickness Measurements Requirements
1. Within the cargo area: .1 Each deck plate (see note) .2 Three transverse sections .3 Each bottom plate
2. Measurements of structural members subject to close-up survey according to 7.2.2, for general assessment and recording of corrosion pattern
3. Suspect areas
4. Selected wind and water strakes outside the cargo area
5. All wind and water strakes within the cargo area
6. Internal structure in the fore and aft peak tanks
7. All exposed main deck plates outside the cargo area and all exposed first tier superstructure deck plates

Note:

In conjunction with thickness measurement procedures, in case of concern regarding residual throat thickness of the fillet weld between the deck plate and deck longitudinals or possible detachment of a deck longitudinal member, the attending surveyor may refer to the Guidelines on the assessment of residual fillet weld between deck plating and longitudinals adopted by resolution MEPC.147(54).

8 Acceptance Criteria

The acceptance criteria for the CAS shall be those set out in the 2011 *ESP* Code, as amended.

9 CAS Survey Reports

- 9.1 A survey report shall be completed for the CAS survey. The report shall indicate the date, location (place), and where relevant, whether or not the CAS survey was carried out in dry-dock afloat or at sea. When the CAS survey is split between different survey stations, a report shall be made for each portion of the CAS survey.
- 9.2 Survey records relating to the CAS survey, including actions taken, shall form an auditable documentary trail, which shall be made available to the Administration, if requested.
- 9.3 In addition, the following shall be included in each CAS survey report:
- .1 Extent of the Survey:
 - .1 identification of the spaces where an overall survey has been carried out;
 - .2 identification of location, in each space, where a close-up survey has been carried out, together with the means of access used; and
 - .3 identification of the spaces, and locations in each space, where thickness measurements have been carried out; and
 - .2 Results of the Survey:
 - .1 extent and condition of coating in each space. Identification of spaces fitted with anodes and the overall condition of the anodes;
 - .2 structural condition reporting for each space, which shall include information on the following, as applicable:
 - .1 corrosion (location and type of corrosion such as grooving, pitting, etc.);
 - .2 cracks (location, description and extent);
 - .3 buckling (location, description and extent);
 - .4 indents (location, description and extent); and
 - .5 areas of substantial corrosion; and
 - .3 Actions taken with respect to findings:
 - .1 details of repairs completed on structural members in identified spaces, including the repair method and extent; and
 - .2 list of items to be kept under observation for planning future inspections and surveys including any thickness measurements.

- 9.4 Where no defects are found, this shall be stated in the report for each space.
- 9.5 The narrative report shall be supplemented by photographs showing the general condition of each space, including representative photographs or sketches of any of the above reported items.
- 9.6 The thickness measurement report shall be verified and endorsed by the attending surveyor.
- 9.7 The attending surveyors shall sign the CAS survey report.

10 CAS Final Report to the Administration

10.1 Review of the CAS by the RO

- 10.1.1 The RO Headquarters shall carry out a verification review of the CAS survey reports, the documents, photographs and other records relating to the CAS, as specified in **section 9**, for the purpose of ascertaining and confirming that the requirements of the CAS have been met.
- 10.1.2 The RO reviewing personnel shall not be engaged in any way whatsoever with the CAS survey under review.

10.2 CAS Final Report to the Administration

- 10.2.1 The RO shall prepare a CAS Final Report to the Administration upon completion of the CAS survey and following the review of the CAS survey reports by the RO's Headquarters, as specified in paragraph 10.1.1.

- 10.2.2 The CAS Final Report shall be submitted by the RO to the Administration without delay and:
- .1 in the case of the CAS survey in accordance with regulation **20.6** or **21.6.1**, not later than 3 *months* after the completion of the CAS survey; or
 - .2 in the case of the CAS survey in accordance with regulation **20.7**, not later than 3 *months* after the completion of the CAS survey, or 2 *months* prior to the date the ship is required to be issued with a Statement of Compliance, whichever occurs earlier.

- 10.2.3 The CAS Final Report shall, at least, include:

- .1 the following general particulars:
 - Ship's name
 - IMO* number
 - Flag State
 - Port of registry
 - Gross tonnage
 - Deadweight (*tonnes*)
 - Summer load line draught
 - Date of delivery
 - Category of ship
 - Date for compliance with regulation **19**
 - Company
 - Report identification reference
- .2 a summary as to where, when, by whom and how the CAS survey was carried out;
- .3 a statement identifying all survey documentation, including the Survey Plan;
- .4 a statement as to the condition of the corrosion prevention system(s) applied to the spaces;
- .5 a statement identifying all thickness measurement reports;
- .6 a summary of the findings of the overall surveys;
- .7 a summary of the findings of the close-up surveys;
- .8 a summary of the hull repairs carried out;
- .9 an identification, together with the location, the extent and the condition, of all areas with substantial corrosion;
- .10 a summary of the results of the evaluation of the thickness measurements, including identification of the areas and sections where thickness measurements were carried out;
- .11 an evaluation of the structural strength of the vessel and an assessment of compliance with the acceptance criteria set out in section 8;

- .12 a statement as to whether all the applicable requirements of the CAS have been met;
- .13 a recommendation to the Administration as to whether the ship should be allowed to continue operating until the date envisaged in regulation **20** for compliance with the requirements of regulation **19** or for the period of validity of the CAS, if earlier; and
- .14 conclusions.

11 Verification of the CAS by the Administration

- 11.1 In addition to any instructions the Administration may have issued to the RO authorized to carry out surveys under the Enhance Survey Programme on its behalf, the Administration shall issue instructions to the RO and to Companies operating Category 2 and Category 3 oil tankers flying its flag, so that the Administration is able to monitor the performance of and verify compliance with the CAS.
- 11.2 The Administration, for the purpose of ensuring uniform and consistent implementation of the CAS, shall establish, at least, procedures through which it will:
- .1 give effect to the requirements of the CAS;
 - .2 monitor the CAS work the RO is carrying out on its behalf;
 - .3 review the CAS Final Report;
 - .4 review cases of ships which have been submitted for the CAS re-assessment; and
 - .5 issue the Statement of Compliance.
- 11.3 The Administration shall review the CAS Final Report prior to the issue of the Statement of Compliance, shall record and document the findings and conclusions of the review and its decision as to the acceptance or rejection of the CAS Final Report and shall produce a Review Record.
- 11.4 The Administration shall ensure that any persons assigned to monitor the execution of the CAS or to review a CAS Final Report:
- .1 are adequately qualified and experienced to the satisfaction of the Administration;
 - .2 are under the direct control of the Administration; and
 - .3 have no connection whatsoever with the RO which carried out the CAS survey under review.

12 Re-assessment of Ships Following Failure to Meet the Requirements of the CAS

- 12.1 A ship which, in the opinion of the Administration, has failed to meet the requirements of the CAS, may be submitted for the CAS re-assessment. In such a case the grounds on which Administration declined the issue of a Statement of Compliance to the ship shall be addressed and dealt with and the remedial actions shall, thereafter, be reviewed for the purpose of ascertaining whether the requirements of the CAS have been complied with.
- 12.2 Such re-assessment, as a rule, shall be carried out by the RO and by the Administration who carried out the previous CAS.
- 12.3 If a ship which has failed to obtain a Statement of Compliance changes flag, the new Administration shall, in accordance with the provisions of regulation **10.3**, request the previous Administration to transmit to them copies of the CAS documentation relating to that ship for the purpose of ascertaining whether the grounds on the basis of which the previous Administration declined the issue to the ship of a Statement of Compliance are dealt with and that the CAS is implemented in a consistent and uniform manner.
- 12.4 As a rule, the CAS re-assessment shall be carried out as soon as possible and in any case, subject to the provisions of paragraph **5.3**, not later than *6 months* following the date on which the Administration has made the decision to decline the issue of a Statement of Compliance to the ship.

13 Statement of Compliance

- 13.1 The Administration shall, in accordance with its procedures, issue to each ship which completes the CAS to the satisfaction of the Administration, the Statement of Compliance.

Such Statement shall be issued:

- .1 in the case of the CAS in accordance with regulation **20.6** or **21.6.1**, not later than *5 months* after the completion of the CAS survey; or
- .2 in the case of the CAS in accordance with regulation **20.7**, not later than *5 months* after the completion of the CAS survey, or the anniversary of the date of delivery of the ship in 2010, whichever occurs earlier, for the first CAS survey,

and not later than the expiry date of the Statement of Compliance for any subsequent CAS survey.

- 13.2 The Statement of Compliance shall be drawn up in the official language of the issuing Administration in a form corresponding to the model given in **Appendix 1**. If the language used is neither English, French or Spanish, the text shall include a translation into one of these languages.
- 13.3 The original of the Statement of Compliance shall be placed on board the ship as a supplement to the ship's International Oil Pollution Prevention Certificate.
- 13.4 In addition, a copy of the CAS Final Report which was reviewed by the Administration for the issue of the Statement of Compliance and a copy of the Review Record, specified in paragraph **11.3**, shall be placed on board to accompany the Statement of Compliance.
- 13.5 A certified copy of the Statement of Compliance and a copy of the Review Record, specified in paragraph **11.3**, shall be forwarded by the Administration to the RO and shall be kept together with the CAS Final Report.
- 13.6 The validity of the Statement of Compliance shall not exceed *5 years* and *6 months* from the date of completion of the CAS survey.
- 13.7 The RO which has carried out the CAS survey in accordance with regulation **20.6** or **21.6.1**, upon satisfactory completion of the survey, shall issue an Interim Statement of Compliance in a form corresponding the model given in **Appendix 1**, for a period not exceeding *5 months*. It shall remain valid until its expiry date or the date of issue of a Statement of Compliance, whichever is the earlier date, and shall be accepted by other Parties to *MARPOL 73/78*.
- 13.8 The flag Administration may consider and declare that the Statement of Compliance of a ship entitled to fly its flag remains valid and in full force and effect if:
- .1 a change in ownership of the ship should occur; or
 - .2 there is a change in the RO from the RO that performed the CAS survey work and prepared the CAS final report, which was reviewed and accepted by the Administration for the issuance of the Statement of Compliance by the Administration, to a new RO acceptable to the Administration, and that all information required to be submitted under the requirements of this resolution has been provided to the new RO; or
 - .3 the safe operation and maintenance of the ship is assumed by a Company, as defined in *SOLAS* chapter IX, other than the one that was operating the ship at the time of the completion of the CAS survey; or
 - .4 any combination of **13.8.1**, **13.8.2** and **13.8.3** should simultaneously occur;
- provided that the Administration:
- .5 maintains the same period of validity; and
 - .6 co-ordinates the transmittal of specific information, requirements, and procedures concerning the maintenance of the validity of the CAS Statement of Compliance in question to the new owner and/or Company, which shall remain those adopted by the Administration at the time of the issue of the original Statement of Compliance.
- 13.9 The Administration shall suspend and/or withdraw the Statement of Compliance of a ship if it is no longer considered to be compliant with the requirements of the CAS.
- 13.10 The Administration may reinstate a suspended and/or withdrawn Statement of Compliance when it is satisfied that the requirements of the CAS are again being met, but not beyond the limits of the period and the terms and conditions of validity of the Statement of Compliance previously established by the Administration.
- 13.11 The Administration shall withdraw the Statement of Compliance of a ship if it is no longer entitled to fly its flag.
- 13.12 If a ship to which a valid Statement of Compliance has already been issued is transferred to the flag of another Party, the new Administration may consider issuing a new Statement of Compliance to that ship on the basis of the Statement of Compliance issued by the previous Administration, provided that the new Administration obtains from the previous Administration:
- .1 a certified copy of the Statement of Compliance that the ship was issued with at the time of the transfer;
 - .2 a statement certifying that the RO, which provided the CAS Final Report to the previous Administration, is an RO authorized to act on its behalf;
 - .3 a status report from the RO that provided the CAS Final Report to the previous Administration that, at the time of transfer, all the terms and conditions justifying the issuance of the Statement of Compliance to that ship are still valid and being maintained; and

- .4 a copy of both the CAS Final Report and the complete Review Record of all the CAS documentation relating to that ship, which the previous Administration has compiled for the issue or renewal and the maintenance of the validity of the Statement of Compliance that the ship was issued with at the time of the transfer.
- 13.13 With a change of flag, for the issuance of an Interim Statement of Compliance issued for a period of not more than 90 *days* to allow the continued operation of the ship while the new Administration performs a technical review and assessment of the CAS Final Report and Review Record, the new Administration shall need only to depend upon the certifications and status report referred to in paragraph **13.12** and provided by the previous Administration and the responsible RO.
- 13.14 On satisfactory completion of the technical review and assessment of the CAS Final Report and Review Record by the new Administration, under the circumstance of a change of flag as described in paragraph **13.12**, a full term Statement of Compliance may be issued by the new Administration limited to the period and no less than the terms and conditions of validity of the Statement of Compliance issued by the previous Administration. In the event the review is unsatisfactory, the new Administration shall revert to the provisions of paragraphs **13.9** and **13.10**.
- 13.15 Should a change of flag take place during the course of a CAS survey, the new Administration shall determine at what point in the CAS Schedule provided in **annex 3** to *MEPC/Circ.390* and under what conditions it will assume responsibility for and allow the CAS survey to continue. Sufficient documentation should be provided by the shipowner and the responsible RO to the new Administration upon which to make its decision.

14 Communication of Information to the Organization

- 14.1 The Administration shall communicate to the Organization:
- .1 particulars of the Statements of Compliance issued;
 - .2 details of the suspension or withdrawal of the Statements of Compliance issued; and
 - .3 particulars of the ships to which it has declined the issue of a Statement of Compliance and reasons thereof.
- 14.2 The Organization shall circulate the aforementioned information to all Parties to *MARPOL 73/78* and shall maintain an electronic database containing the aforesaid information, accessible only to Parties to *MARPOL 73/78*.

Appendix 1

FORM OF STATEMENT OF COMPLIANCE

STATEMENT OF COMPLIANCE

Issued under the provisions of the Condition Assessment Scheme (CAS) adopted by the Organization by resolution MEPC.94(46), as amended* under the authority of the Government of:

.....
(full designation of the country)

Particulars of ship

Name of ship
 Distinctive number or letters
 Port of registry
 Gross tonnage
 Deadweight of ship (tonnes)
 IMO number
 Category of tanker

THIS IS TO CERTIFY:

- 1 That the ship has been surveyed in accordance with the requirements of CAS (resolution MEPC.94(46), as amended);
- 2 That the survey showed that the structural condition of the ship is in all respects satisfactory and the ship complied with the requirements of the CAS.

Date of completion of the CAS survey: dd/mm/yyyy.*

This Statement of Compliance is valid until

Issued at

(Place of issue)

.....
(Date of issue)

.....
*(Signature of duty authorized official
 issuing the Statement)*

(Seal or stamp of the authority, as appropriate)

.....
 * Incorporated from resolution MEPC.112(50)

FORM OF INTERIM STATEMENT OF COMPLIANCE

INTERIM STATEMENT OF COMPLIANCE

Issued under the provisions of the Condition Assessment Scheme (resolution MEPC.94(46), as amended) by:

.....
(full name of the Recognized Organization)

Particulars of ship

Name of ship
 Distinctive number or letters
 Port of registry
 Gross tonnage
 Deadweight of ship (tonnes)
 IMO number
 Category of tanker

THIS IS TO CERTIFY:

- 1 That the ship has been surveyed in accordance with the requirements of the Condition Assessment Scheme (CAS) (resolution MEPC.94(46), as amended);
- 2 That the survey showed that the structural condition of the ship covered by CAS are in all respects satisfactory and the ship complies with the requirements of CAS.

Date of completion of the CAS survey: dd/mm/yyyy.

This Statement is valid until, or the date of issue of the Statement of Compliance, whichever is the earlier date.

Issued at
(Place of issue of the Statement)

.....
(Date of issue)

.....
*(Signature of duty authorized official
 issuing the Statement)*

(Seal or stamp of the Recognized Organization, as appropriate)

Appendix 2**MODEL SURVEY PLAN FOR CAS****Basic Information and Particulars**

Name of Ship	:
IMO Number	:
Flag State	:
Port of Registry	:
Gross Tonnage	:
Deadweight (<i>tonnes</i>)	:
Length Between Perpendiculars (<i>m</i>)	:
Breadth (<i>m</i>)	:
Depth (<i>m</i>)	:
Summer load line draught (<i>m</i>)	:
Builder	:
Hull Number	:
Recognised Organisation (RO)	:
RO Identity	:
Class Notation	:
Date of delivery	:
Category of Ship (1 or 2)	:
Date for compliance with Regulation 19	:
Company	:
Thickness Measurement Firm	:

1 Preamble**1.1 Scope**

1.1.1 The present CAS Survey Plan covers the minimum extent of overall surveys, close-up surveys, thickness measurements and pressure testing within the cargo area, ballast tanks, including fore and aft peak tanks, required by the CAS adopted by resolution MEPC.94(46) as amended by resolution MEPC.99(48) for this ship.

1.1.2 The practical aspects of any part of the CAS survey shall be acceptable to the attending surveyor(s).

1.2 Documentation

All documents used in the development of the CAS survey plan shall be available onboard during the CAS survey as required by paragraph 6.3.1 of the CAS.

2 Arrangement of Tanks

This section of the Plan shall provide information (either in the form of plans or text) on the arrangement of tanks that fall within the scope of the CAS survey.

3 List of Tanks with Information on Their Use, Extent of Coatings and Corrosion Protection System

This section of the Plan shall indicate any changes relating to (and shall update) the information on the use of the tanks of the ship, the extent of coatings and the corrosion protective system provided in the Survey Planning Questionnaire.

4 Conditions for Survey (e.g. Information Regarding Tank Cleaning, Gas Freeing, Ventilation, Lighting etc.)

This section of the Plan shall indicate any changes relating to (and shall update) the information on the conditions for survey provided in the Survey Planning Questionnaire.

5 Provisions and Method of Access to Structures

This section of the Plan shall indicate any changes relating to (and shall update) the information on the provisions and methods of access to structures provided in the Survey Planning Questionnaire.

The Mandatory Requirements for the Safe Conduct of CAS Surveys are contained in Appendix 3 to this Plan.

6 List of Equipment for Survey (to be Provided by the Company and Supplemented by the Recognised Organisation, as Necessary)

This section of the Plan shall identify and list the equipment that will be made available for carrying out the CAS survey and the required thickness measurements.

7 Survey Requirements**7.1 Overall Survey***The CAS requirements*

Paragraph 7.2.1 (and 5.2) of the CAS require that the hull structures in way of cargo tanks, pump rooms, cofferdams, pipe tunnels, void spaces within the cargo area and all ballast tanks shall undergo an overall survey.

The Plan

This section of the Plan shall identify and list the spaces that shall undergo an overall survey for this ship.

7.2 Close up Survey*The CAS requirements*

Paragraph 7.2.2 (and Table 7.2.2) of the CAS state the hull structures that shall undergo a close up survey. These are:

Close up survey requirements
All web frame rings, in all ballast tanks (see note 1)
All web frame rings, in a cargo wing tank, (see note 1)
A minimum of 30% of all web frame rings, in each remaining cargo wing tank (see notes 1 and 3)
All transverse bulkheads, in all cargo and ballast tanks (see note 2)
A minimum of 30 % of the deck and bottom transverses, including adjacent structural members, in each cargo centre tank (see note 3)
Additional complete transverse web frame rings or deck and bottom transverse including adjacent structural members as considered necessary by the surveyor

Notes:

- 1 Complete transverse web frame ring including adjacent structural member.
- 2 Complete transverse bulkhead, including girder and stiffener systems and adjacent members
- 3 The 30% shall be rounded up to the next whole integer.

In addition paragraphs 7.2.3 and 7.2.4 of the CAS provide further guidance as far as the extent and scope of the close up survey.

The Plan

This section of the Plan shall identify and list, using paragraph 7.2.2 (and Table 7.2.2) of the CAS, the hull structures that shall undergo a close up survey for this ship. In particular it shall:

- .1 identify the cargo wing tank in which all web frame rings will undergo close up survey and indicate the number of web frame rings involved;
- .2 identify the remaining cargo wing tanks in which a minimum of 30 % of the web frame rings will undergo a close up survey and indicate, for each tank, the number of web frame rings involved; and
- .3 identify the cargo centre tanks in which a minimum of 30 % of the deck and bottom transverses, including adjacent structural members, in each cargo centre tank will undergo close up survey and indicate, for each tank, the number of the deck and bottom transverses, including adjacent structural members, involved.

8 Identifications of Tanks for Tank Testing*The CAS requirements*

Paragraph 6.2.2.9 of the CAS states that the tank testing shall be as per annex 3 of Annex B of the 2011 *ESP Code* as amended.

The Plan

This section of the Plan shall identify and list the tanks that shall undergo tank testing for this ship.

9 Identification of Areas and Sections for Thickness Measurements*The CAS requirements*

Paragraph 7.3.3 (and Table 7.3.3) of the CAS specify the minimum requirements for thickness measurements for CAS survey. These are as follows:

Thickness measurement requirements	
1.	Within the cargo area:
.1	Each deck plate
.2	Three transverse sections
.3	Each bottom plate
2.	Measurements of structural members subject to close-up survey according to the table above (for close up survey), for general assessment and recording of corrosion pattern
3.	Suspect areas
4.	Selected wind and water strakes outside the cargo area
5.	All wind and water strakes within the cargo area
6.	Internal structure in the fore and aft peak tanks
7.	All exposed main deck plates outside the cargo area and all exposed first tier superstructure deck plates

Guidance Notes:

- 1 The attending surveyor(s) may increase the extent of thickness measurements as deemed necessary (see paragraph 7.3.5 of the CAS).
- 2 Transverse sections for thickness measurements shall be chosen where the largest material reductions are expected to occur or are revealed from deck plating measurements (see section 7.3.8 of the CAS).
- 3 Where substantial corrosion is found, the extent of thickness measurements shall be increased accordingly (see paragraph 7.3.4 of the CAS).

In addition paragraphs 7.3.4 to 7.3.8 of the CAS provide further guidance on the extent and increase of the thickness measurements to be taken.

The Plan

This section of the Plan shall identify and list, using paragraph 7.3.3 (and Table 7.3.3) of the CAS, the areas and sections where thickness measurements shall be taken.

10 Hull Materials (to be Specified by the Recognised Organisation)

This section of the Plan shall identify, using a format similar to that of the table below, the materials used in the hull structures that fall within the scope of the CAS for the purpose of providing a concise reference.

Location	Plating	Longitudinals and Stiffeners	Longitudinal Girders / Stringers	Transverse Girders / Web Frames / Stringers / Floors
Deck				
Bottom				
Inner bottom				
Side shell				
Longitudinal bulkhead				
Transverse bulkheads				
Fore Peak				
Aft Peak				

Guidance Notes:

- 1 Material grade is Mild Steel (MS) where not shown otherwise.
- 2 Material grade HTS indicates High Tensile Steel; SS indicates Stainless Steel; and CS indicates Clad Steel.
- 3 In case of repairs material, grade, type and the extent shall be verified from drawings.

11 Minimum Thickness of Hull Structures (to be Specified by the Recognised Organisation)

This section of the Plan shall specify the minimum thickness* for hull structures of this ship that are subject to the CAS (indicate either (a) or preferably (b), if such information are available):

- (a) Determined from the attached* wastage allowance table and the original thickness according to the hull structure plans of the ship;
- (b) Given in the following table(s)

Area or Location	Original Thickness (mm)	Minimum Thickness (mm)	Substantial Corrosion Thickness (mm)
Deck			
Plating			
Longitudinals			
Longitudinal girders			
Bottom			
Plating			
Longitudinals			
Longitudinal girders			
Ship side			
Plating			
Longitudinals			
Longitudinal girders			
Longitudinal bulkhead			
Plating			
Longitudinals			
Longitudinal girders			
Inner bottom			
Plating			

* The wastage allowance tables shall be attached to the CAS Survey Plan.

Appendices

Appendix 1 - List of Plans

Paragraph 6.2.2.2 of CAS requires that main structural plans of cargo and ballast tanks (scantling drawings), including information on regarding use of high tensile steel (HTS) to be provided.

This Appendix of the Plan shall identify and list the main structural plans which form part of the Plan and which are attached to the Plan.

Appendix 2 - Survey Planning Questionnaire

The Survey Planning Questionnaire, which has been submitted by the Company, shall be appended to the Plan.

Appendix 3 - Mandatory Requirements for the Safe Conduct of CAS Surveys

The Mandatory Requirement for the Safe Conduct of CAS Surveys, which is contained in Appendix 4 shall be appended to the Plan.

Appendix 4 - CAS Schedule

The CAS Schedule shall be attached to the Plan*.

Appendix 5 - Other Documentation

This part of the Plan shall identify and list any other documentation that forms part of the Plan.

Prepared on behalf of the Company by

Date:
 (name and signature of authorised representative)

Reviewed by the Recognized Organization for compliance with paragraph 6.2.2 of the CAS.

Date:
 (name and signature of authorised representative)

* The CAS Schedule is contained in annex 3 to MEPC/Circ.390. The sole purpose of the CAS Schedule is to aid Companies and Recognized Organizations in the preparation of CAS Survey and shall be read and used for this purpose only.

Appendix 3

MANDATORY REQUIREMENTS FOR THE SAFE CONDUCT OF CAS SURVEYS

1 General

1.1 The present mandatory requirements have been developed for the safe conduct of CAS Surveys. Although the mandatory requirements make explicit reference to the CAS survey and to attending surveyor(s) it shall be used also in connection with any thickness measurement work required by the CAS.

2 Conditions for Survey

2.1 The Company shall provide the necessary facilities for a safe conduct of the CAS survey.

2.2 In cases where the provisions of safety and required access are judged by the attending surveyors not to be adequate, the CAS survey of the spaces involved shall not proceed.

2.3 In order to enable the attending surveyors to carry out the CAS survey, provisions for proper and safe access, shall be agreed between Company and Recognised Organisation.

2.4 Details of the means of access are provided in the Survey Planning Questionnaire.

2.5 Tanks and spaces shall be safe for access*. Tanks and spaces shall be gas free and shall be ventilated. Prior to entering a tank, void or enclosed space, it shall be verified that the atmosphere in the tank is free from hazardous gas and contains sufficient oxygen.

2.6 Tanks and spaces shall be sufficiently clean and free from water, scale, dirt, oil residues, corrosion scale, sediments etc., to reveal significant corrosion, deformation, fractures, damages or other structural deterioration as well as the condition of the coating.

2.7 Sufficient illumination shall be provided to reveal significant corrosion, deformation, fractures, damages or other structural deterioration as well as the condition of the coating.

2.8 Where soft coatings have been applied, safe access shall be provided for the attending surveyor(s) to verify the effectiveness of the coating and to carry out an assessment of the conditions of internal structures, which may include spot removal of the coating. Where the presence of soft coating inhibits safe access, the soft coating shall be removed.

2.9 The attending surveyor(s) shall always be accompanied by at least one responsible person assigned by the Company experienced in tank and enclosed spaces inspection. In addition a backup team of at least two experienced persons shall be stationed at the hatch opening of the tank or space that is being surveyed. The back-up team shall continuously observe the work in the tank or space and shall keep lifesaving and evacuation equipment ready for use.

* Reference is made to chapter 10 of the International Safety Guide for Oil Tankers and Terminals (ISGOTT) - Entry into and working in enclosed spaces.

3 Access to Structures

3.1 For overall survey, means shall be provided to enable the attending surveyors to examine the structure in a safe and practical way.

3.2 For close-up survey, one or more of the following means for access, acceptable to the attending surveyors, shall be provided:

- permanent staging and passages through structures
- temporary staging and passages through structure
- lifts and moveable platforms
- rafts or boats
- other equivalent means.

3.3 Surveys of tanks or spaces by means of rafts or boats may only be undertaken with the agreement of the attending surveyors, who shall take into account the safety arrangements provided, including weather forecasting and ship response in reasonable sea conditions.

3.4 When rafts or boats will be used for close up survey the following conditions shall be observed:

- .1 only rough duty, inflatable rafts or boats, having satisfactory residual buoyancy and stability even if one chamber is ruptured, shall be used;
- .2 the boat or raft shall be tethered to the access ladder and an additional person shall be stationed down the access ladder with a clear view of the boat or raft;
- .3 appropriate lifejackets shall be available for all participants;
- .4 the surface of water in the tank shall be calm (under all foreseeable conditions the expected rise of water within the tank shall not exceed 0.25 m) and the water level either stationary or falling. On no account shall the level of the water be rising while the boat or raft is in use;
- .5 the tank or space must contain clean ballast water only. Even a thin sheen of oil on the water is not acceptable;
- .6 at no time shall the water level be allowed to be within 1 m of the deepest under deck web face flat so that the survey team is not isolated from a direct escape route to the tank hatch. Filling to levels above the deck transverse shall only be contemplated if a deck access manhole is fitted and open in the bay being examined, so that an escape route for the survey party is available at all times;
- .7 if the tanks (or spaces) are connected by a common venting system, or Inert Gas system, the tank in which the boat or raft is to be used shall be isolated to prevent a transfer of gas from other tanks (or spaces).

3.5 In addition to the above rafts or boats alone may be allowed for inspection of the under deck areas for tanks or spaces, if the depth of the webs are 1.5 m or less.

3.6 If the depth of the webs is more than 1.5 m, rafts or boats alone may be allowed only:

- .1 when the coating of the under deck structure is in GOOD condition and there no evidence of wastage;
or
- .2 if a permanent means of access is provided in each bay to allow safe entry and exit. This means of access is to be direct from the deck via a vertical ladder and a small platform shall be fitted approximately 2 m below the deck.

If neither of the above conditions are met then staging shall be provided for the survey of the under deck area.

4 Equipment for Survey

4.1 Thickness measurement shall normally be carried out by means of ultrasonic test equipment. The accuracy of the equipment shall be proven to the attending surveyor(s) as required.

4.2 One or more of the following fracture detection procedures may be required if deemed necessary by the attending surveyor(s):

- radiographic equipment
- ultrasonic equipment
- magnetic particle equipment
- dye penetrant
- other equivalent means.

4.3 Explosimeter, oxygen-meter, breathing apparatus, lifelines, riding belts with rope and hook and whistles together with instructions and guidance on their use shall be made available during the CAS survey. A safety check-list shall be provided.

4.4 Adequate and safe lighting shall be provided for the safe and efficient conduct of the CAS survey.

4.5 Adequate protective clothing shall be made available and used (e.g. safety helmet, gloves, safety shoes, etc) during the CAS survey.

5 Meetings and Communication Arrangements

5.1 The establishment of proper preparation and the close co-operation between the attending surveyors and the Company's representatives onboard prior to and during the CAS survey are an essential part in the safe and efficient conduct of the CAS survey. During the CAS survey on board safety meetings shall be held regularly.

5.2 Prior to commencement of the CAS survey a survey meeting shall be held between the attending surveyors the Company's representative(s) in attendance, the TM Firm Operator (as applicable) and the Master of the ship for the purpose to ascertain that all the arrangements envisaged in the Survey Plan are in place, so as to ensure the safe and efficient conduct of the survey work to be carried out.

5.3 The following is an indicative list of items that shall be addressed in the meeting:

- .1 schedule of the vessel (i.e. the voyage, docking and undocking manoeuvres, periods alongside, cargo and ballast operations etc.);
- .2 provisions and arrangements for thickness measurements (i.e. access, cleaning/de-scaling, illumination, ventilation, personal safety);
- .3 extent of the thickness measurements;
- .4 acceptance criteria (refer to the list of minimum thicknesses);
- .5 extent of close up survey and thickness measurement considering the coating condition and suspect areas/areas of substantial corrosion;
- .6 execution of thickness measurements;
- .7 taking representative readings in general and where uneven corrosion/pitting is found;
- .8 mapping of areas of substantial corrosion;
- .9 communication between attending surveyor(s) the TM operator(s) and Company representative(s)

concerning findings.

5.4 A communication system shall be arranged between the survey party in the tank or space being examined, the responsible officer on deck and, as the case may be, the navigation bridge. This system shall also include the personnel in charge of handling the ballast pump(s) if rafts or boats are used. The communication arrangements shall be maintained throughout the CAS survey.